

ENERGY  
THAT  
CHANGES



# Sunny Family 2012



» Although each PV plant is unique,  
SMA has the right solution for all demands.

**SUNNY BOY**

1.6 to 5 kW



**Residential System**  
up to 20 kW

**SUNNY MINI CENTRAL**

5 to 11 kW

**SUNNY TRIPOWER**

10 to 20 kW



**Commercial System**  
10 kW up to the MW range

**SUNNY CENTRAL  
and SYSTEM TECHNOLOGY**

250 to 1,600 kW



**PV Power Plant**  
in MW range

**SUNNY ISLAND**

2 to 8 kW



**Off-grid system**  
up to 300 kW

**SUNNY BACKUP**

2 to 5 kW



**Solar power – even in the  
event of grid failure**  
up to 100 kW

**MONITORING SYSTEMS**

plant monitoring



**Everything under control**  
for every PV plant

# CONTENTS

## MEDIUM POWER SOLUTIONS

- 14 INVERTERS WITHOUT TRANSFORMERS
- 40 INVERTERS WITH TRANSFORMERS
- 64 SYSTEM TECHNOLOGY
- 74 BACKUP SYSTEMS
- 86 SMA SERVICE
- 88 SUNNY PRO CLUB
- 92 BONUS PROGRAM

## POWER PLANT SOLUTIONS

- 106 CENTRAL INVERTERS
- 156 SMA SERVICE

## OFF-GRID SOLUTIONS

- 166 OFF-GRID INVERTERS
- 186 WIND POWER INVERTERS
- 212 SMA SERVICE
  
- 220 MONITORING SYSTEMS
- 238 SMA SOLAR ACADEMY
- 242 KNOW-HOW
- 278 REFERENCES
- 284 GLOSSARY



### Note

You can also use the QR code on the following product pages to receive more information.



**Jürgen Dolle,**  
Chief Human Resources Officer



**Roland Grebe,**  
Chief Technology Officer



**Pierre-Pascal Urbon,**  
Speaker of the Managing Board and Chief Financial Officer



**Marko Werner,**  
Chief Sales Officer



# Dear Business Partners, Dear Readers,

The energy revolution is a global challenge and one of the more pressing matters of the present day for politics, technology, and society at large. Renewable energy is already responsible for 20 percent of the overall electricity produced in Germany and is the second most important source of electricity behind coal. More than 90 percent of Germans favor a massive expansion of renewable energy, according to a survey conducted last year by the forsa Institute. People across the globe are also advancing the idea of the energy revolution. They are demanding more sustainability and independence for their energy supply. They are beginning to recognize the infinite possibilities of the sun's energy and demonstrate their foresight by investing in expanding the key technologies of the future and added value locally.

SMA as a technology and global market leader for PV inverters has shown itself to be a driving force for a decentralized, renewable energy supply in its 30 years of existence. Our innovations are contributing to continually expanding the share of photovoltaics in terms of overall energy generation and consistently reducing the system costs of a PV plant. These activities include further simplifying installation, guaranteeing high availability, investing in the performance and reliability of our products, and optimizing production processes. Additional challenges arise as photovoltaics becomes more successful: storage technologies, grid integration, and the optimization of self-consumption are the most important tasks in the continuation of the successful path of photovoltaics. Inverters play a decisive role in maintaining this performance level. For this reason, we invested more than 100 million EUR in developing new products and technologies at SMA in 2011. We consistently use the advancements made in technology in all fields, for example, in storage technologies.

Yet, we do not limit ourselves to technology. We became one of the first manufacturers of PV inverters to have entered a new market by founding our first subsidiary in the U.S. in 2000. Today, SMA has 20 subsidiaries and 85 customer-service stations on four continents. Tendency: increasing. We are improving our focus on customers around the world by orienting our new organizational structure to specific market segments. We have bundled our service competencies into an independent division in the process. At the same time, we have created the perfect infrastructure for PV inverters with our world's largest customer-service center in which we can achieve further improvements in terms of speed and reliability.

Undoubtedly, one of the most exciting tasks of our time is working toward a sustainable, clean, decentralized energy supply. If the challenges are great, the variety of technological solutions is even greater. Our 2012 Product Catalog is designed to provide you with an overview of the performance of our products currently on the market. Complementing the SMA Product Catalog will be a supplement which collects all innovations made available in the course of a year and which will give you an impression of the speed of our innovative cycle.

We look forward to continuing our successful cooperation with you.



Pierre-Pascal Urbon  
Speaker of the Managing Board

# **MEDIUM POWER SOLUTIONS**





## More Benefits – More Added Value

### Solutions for private and commercial PV plants

Operators of small and medium-sized PV plants can turn to SMA Medium Power Solutions for a full range of support services. From residential systems to commercial PV plants with power capacities in the hundreds of kWp.

#### Modular and freely combinable

It's the ideal mix of concepts, ideas and products so they work modularly. In addition to highly efficient inverters for private and commercial PV plants, we provide a range of services such as monitoring solutions, our SMA Service Line and the SMA Bonus

Program. Solar power professionals, plant operators and end customers can rely on the all-inclusive service of SMA Medium Power Solutions.

#### No stone left unturned

SMA products and solutions from Medium Power Solutions handle a number of tasks: from converting electric current and controlling PV plants, to performing grid management services and ensuring intelligent home energy management. That is a lot, but we offer even more: with SMA Medium Power Solutions, solar power professionals

benefit from various professional offers. You can achieve the decisive advantage over the competition in the dynamic solar market:

- SMA services with reliable support and warranty concepts
- The Sunny PRO Club to exchange ideas and knowledge, as well as for marketing purposes
- The SMA Solar Academy with a wide range of seminars
- The SMA Bonus Program with all of the added benefits and prizes





### **The sails are set for the energy revolution**

SMA Medium Power Solutions stand for the continued success of decentralized PV plants in private homes and commercial businesses. More specifically: they stand for customer-oriented offers, even more powerful solutions and the global energy revolution.

#### **AN EXAMPLE OF A PRIVATE AND A COMMERCIAL PV PLANT**

- ① PV modules
- ② Sunny Boy inverter
- ③ PV generation meter
- ④ Feed-in/consumption meter
- ⑤ Load
- ⑥ Sunny Beam
- ⑦ Sunny Explorer
- ⑧ Sunny Tripower inverter
- ⑨ Grid connection





# PV inverters from SMA

## The heart of every PV plant

With a service life of over 20 years and up to 99 percent efficiency, SMA inverters set the standards in this sector. The key to our success: the combination of the latest technologies and modern production processes. The enhanced OptiTrac Global Peak operational control, the asymmetrical Optiflex multi-string technology and the Optiprotect safety concept ensure the best possible performance of the devices 24 hours a day, regardless of the weather.

### Flexible plant design

PV plants are just as individual as the buildings and surfaces on which they are installed. Solar power professionals therefore need to be able to choose from a broad selection of products. SMA provides inverters for each need that arises, allowing the perfect plant design. Our inverters can be installed indoors as well as outdoors.

### Safe installation

With the SMA Grid Guard and the Electronic Solar Switch (ESS), SMA offers the most reliable security system currently available on the market. For countries that require UL listing, the design of these safety technologies differs slightly. The standardized SUNCLIX DC plug-in system, the Quick Module communication unit or the SMA Plug-in Grounding set make installation even easier.

### Seamless monitoring

If you cannot reliably monitor and analyze the electricity you generate, even the best of PV plants is not of much use. The plant operator or solar power professional is only able to make decisions quickly and reliably if this information is available. And your yields are guaranteed.

### Future-proof compatibility

All SMA inverters can be combined with a wide range of plant monitoring components such as the Sunny Beam with *Bluetooth*, the Sunny WebBox for online diagnosis and maintenance, and the Sunny Portal – the world's largest online portal for PV plant monitoring and management. Customers can modify or add on to their plant at any time and know they can rely on high-performance products.



# Medium Power Solutions

## Compatible products

Operators of small and medium-sized PV plants can turn to SMA Medium Power Solutions for a full range of support services. From residential systems to commercial PV plants with power capacities in the hundreds of kWp. Our products and solutions are modular and can handle a number of tasks: from converting electric current and controlling PV plants, to performing grid management services and ensuring intelligent home energy management.

### ■ INVERTERS WITH/WITHOUT TRANSFORMERS



STP 15000TLHE-10  
STP 20000TLHE-10



STP 10000TL-10  
STP 12000TL-10  
STP 15000TL-10  
STP 17000TL-10



SMC 9000TL-10  
SMC 10000TL-10  
SMC 11000TL-10  
SMC 9000TLRP-10  
SMC 10000TLRP-10  
SMC 11000TLRP-10  
SMC 7000HV-11  
SMC 4600A-11  
SMC 5000A-11  
SMC 6000A-11



SB 6000TLUS-12  
SB 7000TLUS-12  
SB 8000TLUS-12  
SB 9000TLUS-12  
SB 10000TLUS-12  
SB 11000TLUS-12  
SB 5000US-12  
SB 6000US-12  
SB 6000US  
SB 7000US-12  
SB 7000US  
SB 8000US-12  
SB 8000US



SB 3000TL-21  
SB 3600TL-21  
SB 4000TL-21  
SB 5000TL-21



SB 3000US  
SB 3000US-12  
SB 3800US-10  
SB 3800US-12  
SB 4000US  
SB 4000US-12



SB 2000HF-30  
SB 2500HF-30  
SB 3000HF-30



SB 2000HFUS-30  
SB 2500HFUS-30  
SB 3000HFUS-30



SB 1600TL-10  
SB 2100TL



■ Compatible products from the Section MONITORING SYSTEMS

---



Sunny Explorer



Sunny Beam



Sunny WebBox



Sunny Portal



Sunny SensorBox



Meter Connection Box



Power Reducer Box



SMA OPC Server



Sunny Design

■ Compatible products from the Section BACKUP SYSTEMS

---



Sunny Backup system M  
Sunny Backup system L  
Sunny Backup system XL



Sunny Backup set S



Meter Box  
for Sunny Backup



# INVERTERS WITHOUT TRANSFORMERS





**HIGH EFFICIENCY OF 99 %**

**Economical**

- The best efficiency in its class at 99 %
- SMA OptiTrac MPP tracking for best MPP tracking efficiency
- Active temperature management with OptiCool
- Bluetooth communication

**Simple**

- Three-phase grid feed-in
- Cable connection without tools
- SUNCLIX DC plug-in system

**Flexible & future-proof**

- DC input voltage up to 1000 V
- Integrated grid management functions
- Reactive-power capable



**SUNNY TRIPOWER 15000TL / 20000TL  
HIGH EFFICIENCY**

Highly profitable and extremely efficient

Previously unachieved efficiency that guarantees short payback periods: at 99 %, the new Sunny Tripower TL High Efficiency provides the best efficiency level in its class. The reduction in conversion losses by half and the further improved specific price make it the ideal decentralized inverter solution for highly efficient medium to large-sized PV plants. This particular product version is tailored toward attaining the highest possible levels of efficiency: the Sunny Tripower TL High Efficiency focuses on the essentials and meets all requirements, including reactive power provision, grid support, and grid management integration.

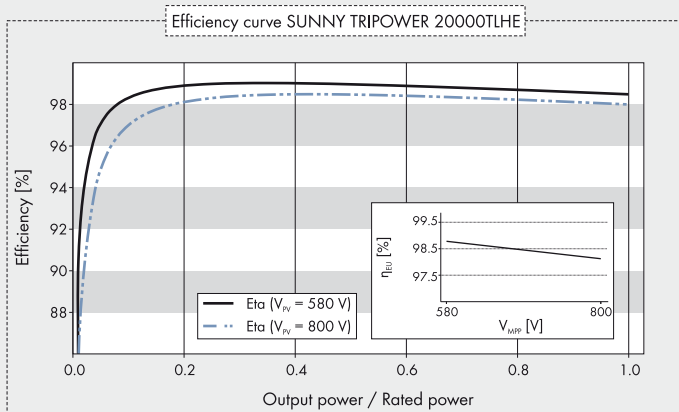

## Accessories

 RS485 interface  
DM-485CB-10

 Multifunction relay  
MFRO1-10

<sup>1</sup> Does not apply to all national appendices of EN 50438

● Standard feature ○ Optional feature – Not available  
Data at nominal conditions

Technical data	Sunny Tripower 15000TL	Sunny Tripower 20000TL
<b>Input (DC)</b>		
Max. DC power (@ $\cos \varphi = 1$ )	15200 W	20300 W
Max. input voltage	1000 V	1000 V
MPP voltage range @ 230 V line voltage	580 V - 800 V	580 V - 800 V
Min. input voltage / initial input voltage	570 V / 620 V	570 V / 620 V
Max. input current	36 A	36 A
Max. input current per string	36 A	36 A
Number of independent MPP inputs / strings per MPP input	1 / 6	1 / 6
<b>Output (AC)</b>		
Rated power (@ 230 V, 50 Hz)	15000 W	20000 W
Max. apparent AC power	15000 VA	20000 VA
Nominal AC voltage	3 / N / PE, 230 V / 400 V	3 / N / PE, 230 / 400 V
Nominal AC voltage range	160 V - 280 V	160 V - 280 V
AC power frequency / range	50 Hz, 60 Hz / -6 Hz ... +5 Hz	50 Hz, 60 Hz / -6 Hz ... +5 Hz
Rated power frequency / rated grid voltage	50 Hz / 230 V	50 Hz / 230 V
Max. output current	24 A	29 A
Power factor at rated power	1	1
Adjustable displacement power factor	0.8 overexcited ... 0.8 underexcited	0.8 overexcited ... 0.8 underexcited
Feed-in phases / connection phases	3 / 3	3 / 3
<b>Efficiency</b>		
Max. efficiency / European weighted efficiency	99 % / 98.7 %	99 % / 98.7 %
<b>Protective devices</b>		
DC disconnect device	○	○
Ground fault monitoring / grid monitoring	● / ●	● / ●
DC surge arrester type II	–	–
DC reverse polarity protection / AC short-circuit current capability / galvanically isolated	● / ● / –	● / ● / –
All-pole-sensitive residual-current monitoring unit	●	●
Protection class (according to IEC 62103) / overvoltage category (according to IEC 60664-1)	I / III	I / III
<b>General data</b>		
Dimensions (W / H / D)	665 / 680 / 265 mm (26.2 / 26.8 / 10.4 inch)	665 / 680 / 265 mm (26.2 / 26.8 / 10.4 inch)
Weight	45 kg / 99.2 lb	45 kg / 99.2 lb
Operating temperature range	-25 °C ... +60 °C / -13 °F ... +140 °F	-25 °C ... +60 °C / -13 °F ... +140 °F
Noise emission (typical)	51 dB(A)	51 dB(A)
Self-consumption (night)	1 W	1 W
Topology / cooling concept	Transformerless / OptiCool	Transformerless / OptiCool
Degree of protection: electronics / connection area (according to IEC 60529)	IP65 / IP54	IP65 / IP54
Climatic category (according to IEC 60721-3-4)	4K4H	4K4H
Max. permissible value for relative humidity (non-condensing)	100 %	100 %
<b>Features</b>		
DC coupling	SUNCLIX	SUNCLIX
AC coupling	Spring clamp terminal	Spring clamp terminal
Display	Graphic	Graphic
Interfaces: RS485 / Bluetooth / multi-function relay	○ / ● / ○	○ / ● / ○
Warranty: 5 / 10 / 15 / 20 / 25 years	● / ○ / ○ / ○ / ○	● / ○ / ○ / ○ / ○
Certificates and approvals (more available on request)	CE, VDE0126-1-1, RD 661/2007, PPC, EN 50438 <sup>1</sup> , PPDS, UTE C15-712-1, G59/2, VDE-AR-N 4105, BDEW 2008, RD1699, AS 4777, C10/11, IEC 61727	
Type designation	STP 15000TLHE-10	STP 20000TLHE-10



#### Economical

- Maximum efficiency of 98.2 %
- SMA OptiTrac Global Peak MPP tracking for best MPP tracking efficiency
- *Bluetooth* communication

#### Reliable

- Triple protection with Optiprotect: electric string fuses, self-learning string failure detection, DC surge arrester which can be integrated (type II)

#### Flexible

- DC input voltage up to 1000 V
- Integrated grid management functions
- Tailor made plant design with Optiflex

#### Simple

- Three-phase grid feed-in
- Cable connection without tools
- SUNCLIX DC plug-in system
- Easily accessible connection area



## SUNNY TRIPower 10000TL / 12000TL / 15000TL / 17000TL

The three-phase inverter for easy plant design

Full of pioneering technology: highly flexible plant design with the three-phase Sunny Tripower inverter. Thanks to Optiflex technology, two MPP inputs and a broad input voltage range, it is suited to almost any module configuration. It fulfills all requirements such as those for reactive power provision and grid support, and it is thus a reliable participant in grid management. The Optiprotect safety concept, with its self-learning string failure detection, electronic string fuse and integrable DC surge arrester type II, ensures maximum availability.





Bad Hersfeld, Germany

# SUNNY TRIPOWER

## 10000TL / 12000TL / 15000TL / 17000TL

Technical data	Sunny Tripower 10000TL	Sunny Tripower 12000TL
<b>Input (DC)</b>		
Max. DC power (@ $\cos \varphi = 1$ )	10200 W	12250 W
Max. input voltage	1000 V	1000 V
MPP voltage range / rated input voltage	320 V - 800 V / 600 V	380 V - 800 V / 600 V
Min. input voltage / initial input voltage	150 V / 188 V	150 V / 188 V
Max. input current input A / input B	22 A / 11 A	22 A / 11 A
Max. input current per string input A <sup>2</sup> / input B <sup>2</sup>	33 A / 12.5 A	33 A / 12.5 A
Number of independent MPP inputs / strings per MPP input	2 / A:4, B:1	2 / A:4, B:1
<b>Output (AC)</b>		
Rated power (@ 230 V, 50 Hz)	10000 W	12000 W
Max. apparent AC power	10000 VA	12000 VA
Nominal AC voltage	3 / N / PE; 220 / 380 V, 3 / N / PE; 230 / 400 V, 3 / N / PE; 240 / 415 V	3 / N / PE; 220 / 380 V, 3 / N / PE; 230 / 400 V, 3 / N / PE; 240 / 415 V
Nominal AC voltage range	160 V - 280 V	160 V - 280 V
AC power frequency / range	50 Hz, 60 Hz / -6 Hz ... +5 Hz	50 Hz, 60 Hz / -6 Hz ... +5 Hz
Rated power frequency / rated grid voltage	50 Hz / 230 V	50 Hz / 230 V
Max. output current	16 A	19.2 A
Power factor at rated power	1	1
Adjustable displacement power factor	0.8 overexcited ... 0.8 underexcited	0.8 overexcited ... 0.8 underexcited
Feed-in phases / connection phases	3 / 3	3 / 3
<b>Efficiency</b>		
Max. efficiency / European weighted efficiency	98.1 % / 97.7 %	98.1 % / 97.7 %
<b>Protective devices</b>		
DC disconnect device	●	●
Ground fault monitoring / grid monitoring	● / ●	● / ●
DC surge arrester type II	○	○
DC reverse polarity protection / AC short-circuit current capability / galvanically isolated	● / ● / -	● / ● / -
All-pole-sensitive residual-current monitoring unit	●	●
Protection class (according to IEC 62103) / overvoltage category (according to IEC 60664-1)	I / III	I / III
<b>General data</b>		
Dimensions (W / H / D)	665 / 690 / 265 mm (26.2 / 27.2 / 10.4 inch)	665 / 690 / 265 mm (26.2 / 27.2 / 10.4 inch)
Weight	59 kg / 130.07 lb	59 kg / 130.07 lb
Operating temperature range	-25 °C ... +60 °C / -13 °F ... +140 °F	-25 °C ... +60 °C / -13 °F ... +140 °F
Noise emission (typical)	51 dB(A)	51 dB(A)
Self-consumption (night)	1 W	1 W
Topology / cooling concept	Transformerless / OptiCool	Transformerless / OptiCool
Degree of protection / connection area degree of protection (according to IEC 60529)	IP65 / IP54	IP65 / IP54
Climatic category (according to IEC 60721-3-4)	4K4H	4K4H
Max. permissible value for relative humidity (non-condensing)	100 %	100 %
<b>Features</b>		
DC coupling	SUNCLIX	SUNCLIX
AC coupling	Spring clamp terminal	Spring clamp terminal
Display	Graphic	Graphic
Interface: RS485 / Bluetooth / multi-function relay	○ / ● / ●	○ / ● / ●
Warranty: 5 / 10 / 15 / 20 / 25 years	● / ○ / ○ / ○ / ○	● / ○ / ○ / ○ / ○
Certificates and approvals (more available on request)	CE, VDE0126-1-1, RD661/2007, PPC, AS4777, EN50438 <sup>1</sup> , C10/11, PPDS, IEC61727, ENEL-Guida, UTEC15-712-1, G59/2, VDEAR-N4105, BDEW 2008, RD1699	
Certificates and approvals (planned)	CEI 0-21	
Type designation	STP 10000TL-10	STP 12000TL-10



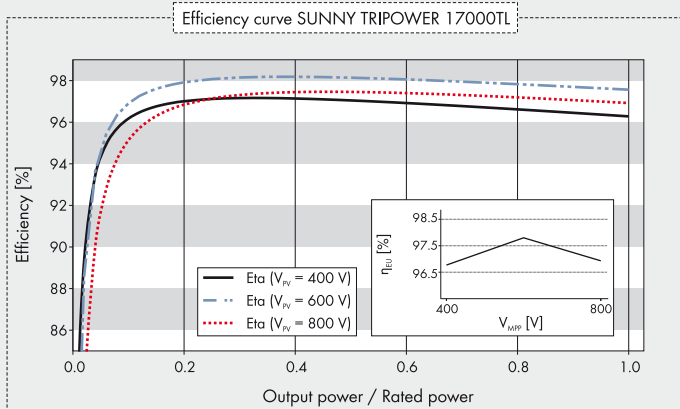

Accessories



RS485 interface  
DM-485CB-10



DC surge arrester (type II),  
input A DCSPD KIT1-10



DC surge arrester  
(type II), inputs A and  
B DCSPD KIT2-10

<sup>1</sup> Does not apply to all national appendices of EN 50438

<sup>2</sup> To be observed in the event of short-circuit of the string fuse.

● Standard feature ○ Optional feature – Not available  
Data at nominal conditions

Technical data	Sunny Tripower 15000TL	Sunny Tripower 17000TL
<b>Input (DC)</b>		
Max. DC power (@ cos φ = 1)	15340 W	17410 W
Max. input voltage	1000 V	1000 V
MPP voltage range / rated input voltage	360 V – 800 V / 600 V	400 V – 800 V / 600 V
Min. input voltage / initial input voltage	150 V / 188 V	150 V / 188 V
Max. input current input A / input B	33 A / 11 A	33 A / 11 A
Max. input current per string input A <sup>2</sup> / input B <sup>2</sup>	40 A / 12.5 A	40 A / 12.5 A
Number of independent MPP inputs / strings per MPP input	2 / A:5; B:1	2 / A:5; B:1
<b>Output (AC)</b>		
Rated power (@ 230 V, 50 Hz)	15000 W	17000 W
Max. apparent AC power	15000 VA	17000 VA
Nominal AC voltage	3 / N / PE; 220 / 380 V, 3 / N / PE; 230 / 400 V, 3 / N / PE; 240 / 415 V	3 / N / PE; 220 / 380 V, 3 / N / PE; 230 / 400 V, 3 / N / PE; 240 / 415 V
Nominal AC voltage range	160 V – 280 V	160 V – 280 V
AC power frequency / range	50 Hz, 60 Hz / -6 Hz ... +5 Hz	50 Hz, 60 Hz / -6 Hz ... +5 Hz
Rated power frequency / rated grid voltage	50 Hz / 230 V	50 Hz / 230 V
Max. output current	24 A	24.6 A
Power factor at rated power	1	1
Adjustable displacement power factor	0.8 overexcited ... 0.8 underexcited	0.8 overexcited ... 0.8 underexcited
Feed-in phases / connection phases	3 / 3	3 / 3
<b>Efficiency</b>		
Max. efficiency / European weighted efficiency	98.2 % / 97.8 %	98.2 % / 97.8 %
<b>Protective devices</b>		
DC disconnect device	●	●
Ground fault monitoring / grid monitoring	● / ●	● / ●
DC surge arrester type II	○	○
DC reverse polarity protection / AC short-circuit current capability / galvanically isolated	● / ● / –	● / ● / –
All-pole-sensitive residual-current monitoring unit	●	●
Protection class (according to IEC 62103) / overvoltage category (according to IEC 60664-1)	I / III	I / III
<b>General data</b>		
Dimensions (W / H / D)	665 / 690 / 265 mm (26.2 / 27.2 / 10.4 inch)	665 / 690 / 265 mm (26.2 / 27.2 / 10.4 inch)
Weight	59 kg / 130.07 lb	59 kg / 130.07 lb
Operating temperature range	-25 °C ... +60 °C / -13 °F ... +140 °F	-25 °C ... +60 °C / -13 °F ... +140 °F
Noise emission (typical)	51 dB(A)	51 dB(A)
Self-consumption (night)	1 W	1 W
Topology / cooling concept	Transformerless / OptiCool	Transformerless / OptiCool
Degree of protection / connection area degree of protection (according to IEC 60529)	IP65 / IP54	IP65 / IP54
Climatic category (according to IEC 60721-3-4)	4K4H	4K4H
Max. permissible value for relative humidity (non-condensing)	100 %	100 %
<b>Features</b>		
DC coupling	SUNCLIX	SUNCLIX
AC coupling	Spring clamp terminal	Spring clamp terminal
Display	Graphic	Graphic
Interface: RS485 / Bluetooth / multi-function relay	○ / ● / ●	○ / ● / ●
Warranty: 5 / 10 / 15 / 20 / 25 years	● / ○ / ○ / ○ / ○ / ○	● / ○ / ○ / ○ / ○ / ○
Certificates and approvals (more available on request)	CE, VDE0126-1-1, RD661/2007, PPC, AS4777, EN50438 <sup>1</sup> , C10/11, PPDS, IEC61727, ENEL-Guida, UTEC15-712-1, G59/2, VDEAR-N4105, BDEW 2008, RD1699	CE, VDE0126-1-1, RD661/2007, PPC, AS4777, EN50438 <sup>1</sup> , C10/11, PPDS, IEC61727, ENEL-Guida, UTEC15-712-1, G59/2, VDEAR-N4105, BDEW 2008, RD1699
Certificates and approvals (planned)	CEI Q-21	CEI Q-21
Type designation	STP 15000TL-10	STP 17000TL-10



#### Flexible

- Reactive power supply

#### High yields

- Maximum efficiency of 97.7 %
- Transformerless, with H5 topology
- OptiCool active temperature management

#### Reliable

- Pluggable SMA Power Balancer for three-phase grid connection
- Integrated ESS DC switch-disconnector
- Monitored string fuses

#### Simple

- SUNCLIX DC plug-in system



## SUNNY MINI CENTRAL 9000TL / 10000TL / 11000TL with Reactive Power Control

Optimum grid integration with reactive power supply

Sunny Mini Central inverters with Reactive Power Control are the ideal solution when utility companies demand reactive power supply. They can be used to realize plant designs which specify for the displacement factor  $\cos \varphi$  and the corresponding percentage of reactive power. Large PV power stations can now make optimum use of grid distribution capacities, which significantly contributes to the success of renewable energy.



Thiva, Greece

# SUNNY MINI CENTRAL 9000TL / 10000TL / 11000TL

## with Reactive Power Control

Technical data	Sunny Mini Central 9000TL	Sunny Mini Central 10000TL
<b>Input (DC)</b>		
Max. DC power (@ $\cos \varphi = 1$ )	9300 W	10350 W
Max. input voltage	700 V	700 V
MPP voltage range / rated input voltage	333 V - 500 V / 350 V	333 V - 500 V / 350 V
Min. input voltage / initial input voltage	333 V / 400 V	333 V / 400 V
Max. input current	28 A	31 A
Max. input current per string	28 A	31 A
Number of independent MPP inputs / strings per MPP input	1 / 5	1 / 5
<b>Output (AC)</b>		
Rated power (@ 230 V, 50 Hz)	9000 W	10000 W
Max. apparent AC power	9000 VA	10000 VA
Nominal AC voltage / range	220 V, 230 V, 240 V / 180 V - 265 V	220 V, 230 V, 240 V / 180 V - 265 V
AC power frequency / range	50 Hz, 60 Hz / -6 Hz ... +5 Hz	50 Hz, 60 Hz / -6 Hz ... +5 Hz
Rated power frequency / rated grid voltage	50 Hz / 230 V	50 Hz / 230 V
Max. output current	40 A	44 A
Power factor at rated power	1	1
Adjustable displacement power factor	0.8 overexcited ... 0.8 underexcited	0.8 overexcited ... 0.8 underexcited
Feed-in phases / connection phases	1 / 1	1 / 1
Power balancing	●	●
<b>Efficiency</b>		
Max. efficiency / European weighted efficiency	97.7% / 97.3%	97.7% / 97.2%
<b>Protective devices</b>		
Reverse current protection / DC disconnect device	Optional (fuses) / ●	Optional (fuses) / ●
Ground fault monitoring / grid monitoring	● / ●	● / ●
DC reverse polarity protection / AC short-circuit current capability / galvanically isolated	● / ● / -	● / ● / -
All-pole-sensitive residual-current monitoring unit	●	●
Protection class (according to IEC 62103) / overvoltage category (according to IEC 60664-1)	I / III	I / III
<b>General data</b>		
Dimensions (W / H / D)	468 / 613 / 242 mm (18.4 / 24.1 / 9.5 inch)	468 / 613 / 242 mm (18.4 / 24.1 / 9.5 inch)
Weight	35 kg / 77.16 lb	35 kg / 77.16 lb
Operating temperature range	-25 °C ... +60 °C / -13 °F ... +140 °F	-25 °C ... +60 °C / -13 °F ... +140 °F
Noise emission (typical)	42 dB(A)	45 dB(A)
Self-consumption (night)	0.25 W	0.25 W
Topology	Transformerless	Transformerless
Cooling concept	OptiCool	OptiCool
Degree of protection (according to IEC 60529)	IP65	IP65
Degree of protection of connection area (according to IEC 60529)	IP65	IP65
Climatic category (according to IEC 60721-3-4)	4K4H	4K4H
Max. permissible value for relative humidity (non-condensing)	100 %	100 %
<b>Features</b>		
DC coupling	SUNCLIX	SUNCLIX
AC coupling	Screw terminal	Screw terminal
Display	Text line	Text line
Interface: RS485 / Bluetooth	○ / ○	○ / ○
Warranty: 5 / 10 / 15 / 20 / 25 years	● / ○ / ○ / ○ / ○	● / ○ / ○ / ○ / ○
Certificates and approvals (more available on request)	CE, VDE0126-1-1, AR4105, EN50438 <sup>1</sup> , C10/11, PPDS, IEC61727, UTEC15-712-1, RD1699, RD 661/2007	
Type designation	SMC 9000TLRP-10	SMC 10000TLRP-10



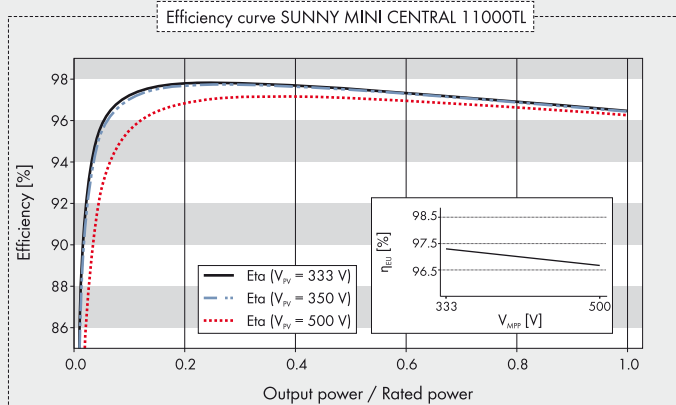

## Accessories

 RS485 interface  
485PB-SMC-NR

 Bluetooth  
Piggy-Back BTPBINV-NR

 SMA Power Balancer  
connection cable  
PBL-YCABLE-10

<sup>1</sup> Does not apply to all national appendices of EN 50438

 ● Standard feature ○ Optional feature – Not available  
Data at nominal conditions

Technical data	Sunny Mini Central 11000TL	
<b>Input (DC)</b>		
Max. DC power (@ $\cos \varphi = 1$ )	11400 W	
Max. input voltage	700 V	
MPP voltage range / rated input voltage	333 V - 500 V / 350 V	
Min. input voltage / initial input voltage	333 V / 400 V	
Max. input current	34 A	
Max. input current per string	34 A	
Number of independent MPP inputs / strings per MPP input	1 / 5	
<b>Output (AC)</b>		
Rated power (@ 230 V, 50 Hz)	11000 W	
Max. apparent AC power	11000 VA	
Nominal AC voltage / range	220 V, 230 V, 240 V / 180 V - 265 V	
AC power frequency / range	50 Hz, 60 Hz / -6 Hz ... +5 Hz	
Rated power frequency / rated grid voltage	50 Hz / 230 V	
Max. output current	48 A	
Power factor at rated power	1	
Adjustable displacement power factor	0.8 overexcited ... 0.8 underexcited	
Feed-in phases / connection phases	1 / 1	
Power balancing	●	
<b>Efficiency</b>		
Max. efficiency / European weighted efficiency	97.7% / 97.2%	
<b>Protective devices</b>		
Reverse current protection / DC disconnect device	Optional (fuses) / ●	
Ground fault monitoring / grid monitoring	● / ●	
DC reverse polarity protection / AC short-circuit current capability / galvanically isolated	● / ● / –	
All-pole-sensitive residual-current monitoring unit	●	
Protection class (according to IEC 62103) / overvoltage category (according to IEC 60664-1)	I / III	
<b>General data</b>		
Dimensions (W / H / D)	468 / 613 / 242 mm (18.4 / 24.1 / 9.5 inch)	
Weight	35 kg / 77.16 lb	
Operating temperature range	-25 °C ... +60 °C / -13 °F ... +140 °F	
Noise emission (typical)	46 dB(A)	
Self-consumption (night)	0.25 W	
Topology	Transformerless	
Cooling concept	OptiCool	
Degree of protection (according to IEC 60529)	IP65	
Degree of protection of connection area (according to IEC 60529)	IP65	
Climatic category (according to IEC 60721-3-4)	4K4H	
Max. permissible value for relative humidity (non-condensing)	100 %	
<b>Features</b>		
DC coupling	SUNCLIX	
AC coupling	Screw terminal	
Display	Text line	
Interface: RS485 / Bluetooth	○ / ○	
Warranty: 5 / 10 / 15 / 20 / 25 years	● / ○ / ○ / ○ / ○	
Certificates and approvals (more available on request)	CE, VDE0126-1-1, AR4105, EN50438 <sup>1</sup> , C10/11, PPDS, IEC61727, UTE15-712-1, RD1699, RD 661/2007	
Type designation	SMC 11000TLRP-10	



#### Economical

- Maximum efficiency of 98 %
- The best MPP tracking efficiency with OptiTrac MPP tracking
- Transformerless, with H5 topology

- OptiCool active temperature management

#### Reliable

- Pluggable SMA Power Balancer for three-phase grid connection
- Integrated ESS DC switch-disconnector
- Monitored string fuses

#### Simple

- SUNCLIX DC plug-in system



## SUNNY MINI CENTRAL 9000TL / 10000TL / 11000TL

Precise plant design for maximum yield

Simple realization of medium and large-scale PV plants from 27 kWp up to the megawatt range: the Sunny Mini Central inverters in the power classes from nine to eleven kW allow almost limitless possibilities and are easy to combine. The combination of high efficiency and low specific price ensures a short amortization time. The decentralized plant design also helps keep maintenance costs low.



Bolzano, Italy

# SUNNY MINI CENTRAL 9000TL / 10000TL / 11000TL

Technical data	Sunny Mini Central 9000TL	Sunny Mini Central 10000TL
<b>Input (DC)</b>		
Max. DC power (@ $\cos \varphi = 1$ )	9300 W	10350 W
Max. input voltage	700 V	700 V
MPP voltage range / rated input voltage	333 V - 500 V / 350 V	333 V - 500 V / 350 V
Min. input voltage / initial input voltage	333 V / 400 V	333 V / 400 V
Max. input current	28 A	31 A
Max. input current per string	28 A	31 A
Number of independent MPP inputs / strings per MPP input	1 / 5	1 / 5
<b>Output (AC)</b>		
Rated power (@ 230 V, 50 Hz)	9000 W	10000 W
Max. apparent AC power	9000 VA	10000 VA
Nominal AC voltage / range	220 V, 230 V, 240 V / 180 V - 265 V	220 V, 230 V, 240 V / 180 V - 265 V
AC power frequency / range	50 Hz, 60 Hz / -6 Hz ... +5 Hz	50 Hz, 60 Hz / -6 Hz ... +5 Hz
Rated power frequency / rated grid voltage	50 Hz / 230 V	50 Hz / 230 V
Max. output current	40 A	44 A
Power factor at rated power	1	1
Feed-in phases / connection phases	1 / 1	1 / 1
Power balancing	●	●
<b>Efficiency</b>		
Max. efficiency / European weighted efficiency	98 % / 97.6 %	98 % / 97.5 %
<b>Protective devices</b>		
Reverse current protection / DC disconnect device	Optional (fuses) / ●	Optional (fuses) / ●
Ground fault monitoring / grid monitoring	● / ●	● / ●
DC reverse polarity protection / AC short-circuit current capability / galvanically isolated	● / ● / -	● / ● / -
All-pole-sensitive residual-current monitoring unit	●	●
Protection class (according to IEC 62103) / overvoltage category (according to IEC 60664-1)	I / III	I / III
<b>General data</b>		
Dimensions (W / H / D)	468 / 613 / 242 mm (18.4 / 24.1 / 9.5 inch)	468 / 613 / 242 mm (18.4 / 24.1 / 9.5 inch)
Weight	35 kg / 77.16 lb	35 kg / 77.16 lb
Operating temperature range	-25 °C ... +60 °C / -13 °F ... +140 °F	-25 °C ... +60 °C / -13 °F ... +140 °F
Noise emission (typical)	42 dB(A)	45 dB(A)
Self-consumption (night)	0.25 W	0.25 W
Topology	Transformerless	Transformerless
Cooling concept	OptiCool	OptiCool
Degree of protection (according to IEC 60529)	IP65	IP65
Degree of protection of connection area (according to IEC 60529)	IP65	IP65
Climatic category (according to IEC 60721-3-4)	4K4H	4K4H
Max. permissible value for relative humidity (non-condensing)	100 %	100 %
<b>Features</b>		
DC connection	SUNCLIX	SUNCLIX
AC connection	Screw terminal	Screw terminal
Display	Text line	Text line
Interface: RS485 / Bluetooth	○ / ○	○ / ○
Warranty: 5 / 10 / 15 / 20 / 25 years	● / ○ / ○ / ○ / ○	● / ○ / ○ / ○ / ○
Certificates and approvals (more available on request)	CE, VDE0126-1-1, RD 661/2007, PPC, AS 4777, EN 50438 <sup>1</sup> , C10/11, PPDS, IEC 61727, UTE C15-712-1	
Type designation	SMC 9000TL-10	SMC 10000TL-10



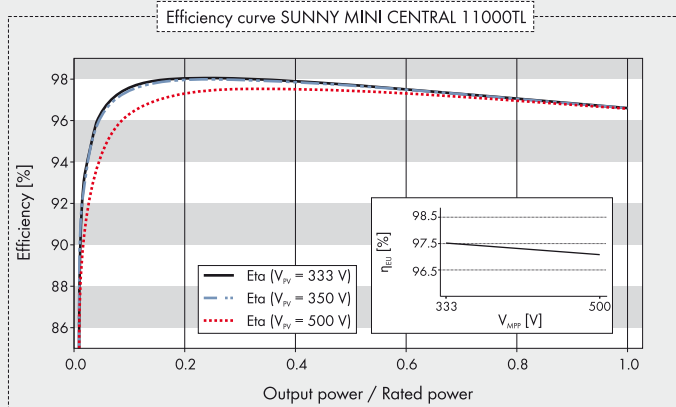

## Accessories



RS485 interface  
485PB-SMC-NR



Bluetooth  
Piggy-Back BTPBINV-NR



SMA Power Balancer  
connection cable  
PBL-YCABLE-10

<sup>1</sup> Does not apply to all national appendices of EN 50438

● Standard feature ○ Optional feature – Not available  
Data at nominal conditions

Technical data	Sunny Mini Central 11000TL	
<b>Input (DC)</b>		
Max. DC power (@ $\cos \varphi = 1$ )	11400 W	
Max. input voltage	700 V	
MPP voltage range / rated input voltage	333 V - 500 V / 350 V	
Min. input voltage / initial input voltage	333 V / 400 V	
Max. input current	34 A	
Max. input current per string	34 A	
Number of independent MPP inputs / strings per MPP input	1 / 5	
<b>Output (AC)</b>		
Rated power (@ 230 V, 50 Hz)	11000 W	
Max. apparent AC power	11000 VA	
Nominal AC voltage / range	220 V, 230 V, 240 V / 180 V - 265 V	
AC power frequency / range	50 Hz, 60 Hz / -6 Hz ... +5 Hz	
Rated power frequency / rated grid voltage	50 Hz / 230 V	
Max. output current	48 A	
Power factor at rated power	1	
Feed-in phases / connection phases	1 / 1	
Power balancing	●	
<b>Efficiency</b>		
Max. efficiency / European weighted efficiency	98 % / 97.5 %	
<b>Protective devices</b>		
Reverse current protection / DC disconnect device	Optional (fuses) / ●	
Ground fault monitoring / grid monitoring	● / ●	
DC reverse polarity protection / AC short-circuit current capability / galvanically isolated	● / ● / -	
All-pole-sensitive residual-current monitoring unit	●	
Protection class (according to IEC 62103) / overvoltage category (according to IEC 60664-1)	I / III	
<b>General data</b>		
Dimensions (W / H / D)	468 / 613 / 242 mm (18.4 / 24.1 / 9.5 inch)	
Weight	35 kg / 77.16 lb	
Operating temperature range	-25 °C ... +60 °C / -13 °F ... +140 °F	
Noise emission (typical)	46 dB(A)	
Self-consumption (night)	0.25 W	
Topology	Transformerless	
Cooling concept	OptiCool	
Degree of protection (according to IEC 60529)	IP65	
Degree of protection of connection area (according to IEC 60529)	IP65	
Climatic category (according to IEC 60721-3-4)	4K4H	
Max. permissible value for relative humidity (non-condensing)	100 %	
<b>Features</b>		
DC connection	SUNCLIX	
AC connection	Screw terminal	
Display	○	
Interface: RS485 / Bluetooth	○ / ○	
Warranty: 5 / 10 / 15 / 20 / 25 years	● / ○ / ○ / ○ / ○	
Certificates and approvals (more available on request)	CE, VDE0126-1-1, RD 661/2007, PPC, AS 4777, EN 50438 <sup>1</sup> , C10/11, PPDS, IEC 61727, UTE C15-712-1	
Type designation	SMC 11000TL-10	



#### Economical

- Maximum efficiency of 97 %
- Multi-string technology in all power classes
- Cost savings due to fewer parallel strings
- Shade management with OptiTrac Global Peak<sup>1</sup>

#### Flexible

- Maximum DC input voltage of 750 V
- Integrated grid management functions through reactive power provision

#### Simple

- Without fan
- Easier wall mounting
- SUNCLIX DC plug-in system
- Quick connection without tools

#### Informative

- Simple country configuration
- *Bluetooth* as standard
- Multi-function relay included



## SUNNY BOY 3000TL / 3600TL / 4000TL / 5000TL with Reactive Power Control

The same. Only better. The universally usable Sunny Boy.

It all remains the best: the new transformerless Sunny Boy is the ideal solution, especially for demanding PV arrays and partly shaded plants. Version 20 of the successful Sunny Boy offers a further array of advantages. It's more flexible in its range of applications, provides even more efficient yields, and it's easier to use. The high DC voltage of 750 V proves to be a cost advantage, since fewer parallel strings are required. In addition, the integrated grid management functions make the devices suitable for universal applications and allow them to actively support the grid.

<sup>1</sup> Verfügbar ab 06/2012

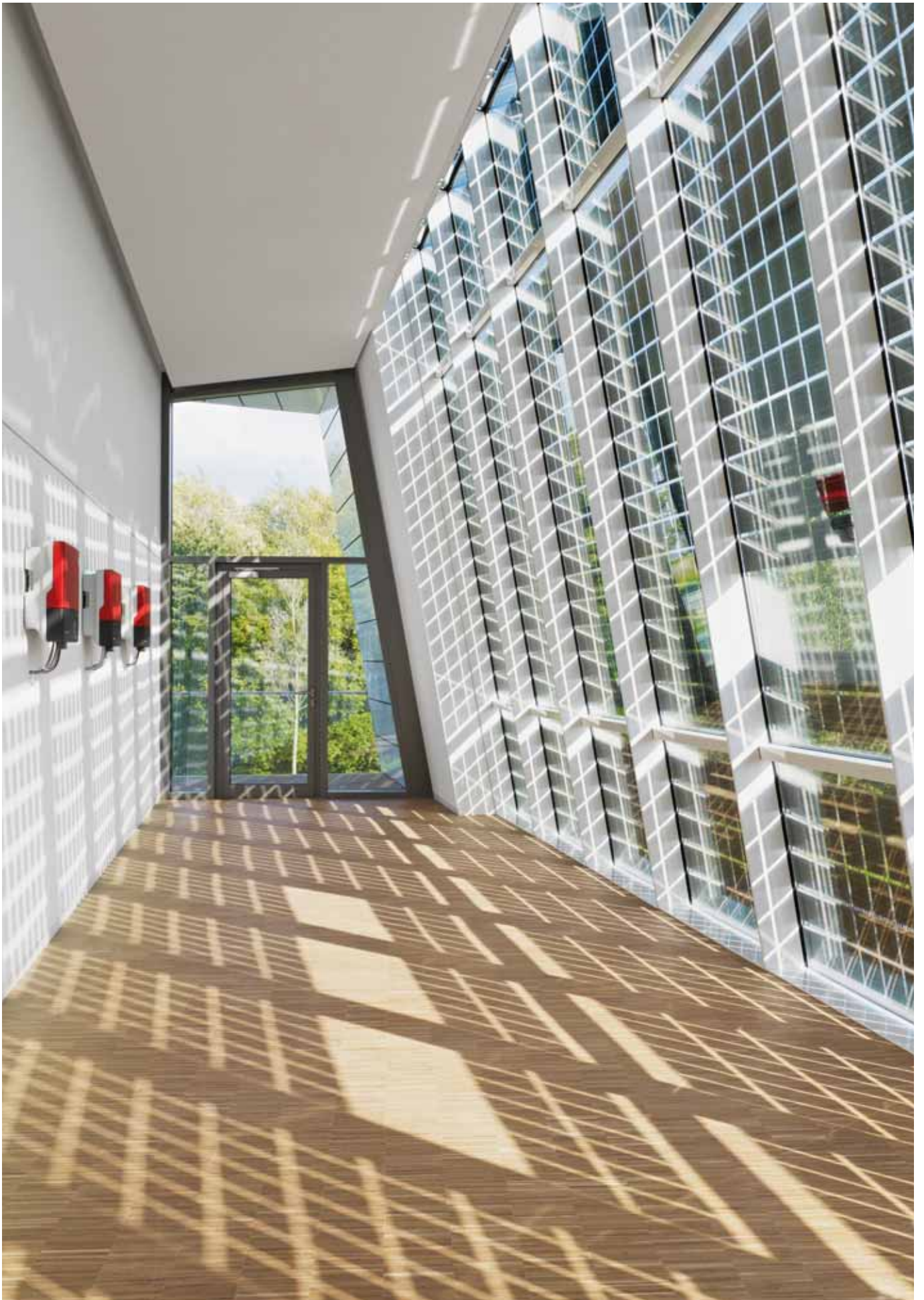

Niestetal, Germany

# SUNNY BOY 3000TL / 3600TL / 4000TL / 5000TL

## with Reactive Power Control

Technical data	Sunny Boy 3000TL	Sunny Boy 3600TL
<b>Input (DC)</b>		
Max. DC power (@ $\cos \varphi = 1$ )	3200 W	3880 W
Max. input voltage	750 V	750 V
MPP voltage range / rated input voltage	175 V - 500 V / 400 V	175 V - 500 V / 400 V
Min. input voltage / initial input voltage	125 V / 150 V	125 V / 150 V
Max. input current input A / input B	15 A / 15 A	15 A / 15 A
Max. input current per string input A / input B	15 A / 15 A	15 A / 15 A
Number of independent MPP inputs / strings per MPP input	2 / A:2; B:2	2 / A:2; B:2
<b>Output (AC)</b>		
Rated power (@ 230 V, 50 Hz)	3000 W	3680 W
Max. apparent AC power	3000 VA	3680 VA
Nominal AC voltage / range	220 V, 230 V, 240 V / 180 V - 280 V	220 V, 230 V, 240 V / 180 V - 280 V
AC power frequency / range	50 Hz, 60 Hz / -5 Hz ... +5 Hz	50 Hz, 60 Hz / -5 Hz ... +5 Hz
Rated power frequency / rated grid voltage	50 Hz / 230 V	50 Hz / 230 V
Max. output current	16 A	16 A
Power factor at rated power	1	1
Adjustable displacement power factor	0.8 overexcited ... 0.8 underexcited	0.8 overexcited ... 0.8 underexcited
Feed-in phases / connection phases	1 / 1	1 / 1
<b>Efficiency</b>		
Max. efficiency / European weighted efficiency	97% / 96%	97% / 96.3%
<b>Protective devices</b>		
DC disconnect device	●	●
Ground fault monitoring / grid monitoring	● / ●	● / ●
DC reverse polarity protection / AC short-circuit current capability / galvanically isolated	● / ● / -	● / ● / -
All-pole-sensitive residual-current monitoring unit	●	●
Protection class (according to IEC 62103) / overvoltage category (according to IEC 60664-1)	I / III	I / III
<b>General data</b>		
Dimensions (W / H / D)	490 / 519 / 185 mm (19.3 / 20.4 / 7.3 inch)	490 / 519 / 185 mm (19.3 / 20.4 / 7.3 inch)
Weight	26 kg / 57.3 lb	26 kg / 57.3 lb
Operating temperature range	-25 °C ... +60 °C / -13 °F ... +140 °F	-25 °C ... +60 °C / -13 °F ... +140 °F
Noise emission (typical)	25 dB(A)	25 dB(A)
Self-consumption (night)	1 W	1 W
Topology	Transformerless	Transformerless
Cooling concept	Convection	Convection
Degree of protection (according to IEC 60529)	IP65	IP65
Degree of protection of connection area (according to IEC 60529)	IP54	IP54
Climatic category (according to IEC 60721-3-4)	4K4H	4K4H
Max. permissible value for relative humidity (non-condensing)	100 %	100 %
<b>Features</b>		
DC connection	SUNCLIX	SUNCLIX
AC connection	Spring clamp terminal	Spring clamp terminal
Display	Graphic	Graphic
Interface: RS485 / Bluetooth / multi-function relay	○ / ● / ●	○ / ● / ●
Warranty: 5 / 10 / 15 / 20 / 25 years	● / ○ / ○ / ○ / ○	● / ○ / ○ / ○ / ○
Certificates and approvals (more available on request)	CE, VDE0126-1-1, C10/11, VDE-AR-N 4105	
Certificates and approvals (planned)	G83/1-1, RD 661/2007, PPC, AS 4777, EN 50438 <sup>1</sup> , MEA, PPDS, IEC 61727, SI4777, UTE C15-712-1, G59/2, CEI 0-21, RD1699	
Type designation	SB 3000TL-21	SB 3600TL-21



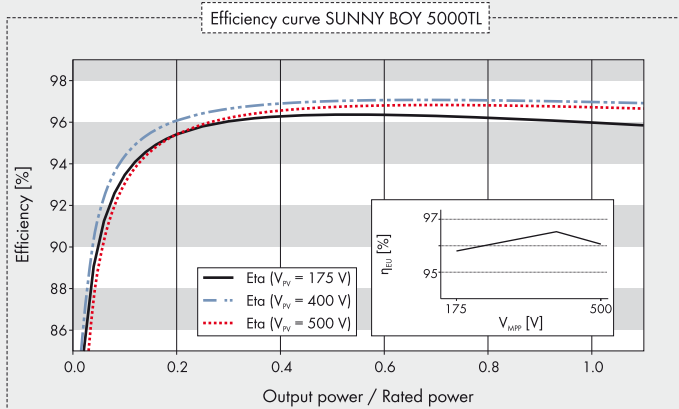

Accessories



RS485 interface  
DM-485CB-10



Additional fan kit  
FANKIT01-10

<sup>1</sup> Does not apply to all national appendices of EN 50438

<sup>2</sup> 4600 VA with VDE-AR-N 4105

<sup>3</sup> 4825 W with VDE-AR-N 4105

● Standard feature ○ Optional feature – Not available  
Data at nominal conditions

Technical data	Sunny Boy 4000TL	Sunny Boy 5000TL
<b>Input (DC)</b>		
Max. DC power (@ cos φ = 1)	4200 W	5250 W <sup>3</sup>
Max. input voltage	750 V	750 V
MPP voltage range / rated input voltage	175 V - 500 V / 400 V	175 V - 500 V / 400 V
Min. input voltage / initial input voltage	125 V / 150 V	125 V / 150 V
Max. input current input A / input B	15 A / 15 A	15 A / 15 A
Max. input current per string input A / input B	15 A / 15 A	15 A / 15 A
Number of independent MPP inputs / strings per MPP input	2 / A:2; B:2	2 / A:2; B:2
<b>Output (AC)</b>		
Rated power (@ 230 V, 50 Hz)	4000 W	4600 W
Max. apparent AC power	4000 VA	5000 VA <sup>2</sup>
Nominal AC voltage / range	220 V, 230 V, 240 V / 180 V - 280 V	220 V, 230 V, 240 V / 180 V - 280 V
AC power frequency / range	50 Hz, 60 Hz / -5 Hz ... +5 Hz	50 Hz, 60 Hz / -5 Hz ... +5 Hz
Rated power frequency / rated grid voltage	50 Hz / 230 V	50 Hz / 230 V
Max. output current	22 A	22 A
Power factor at rated power	1	1
Adjustable displacement power factor	0.8 overexcited ... 0.8 underexcited	0.8 overexcited ... 0.8 underexcited
Feed-in phases / connection phases	1 / 1	1 / 1
<b>Efficiency</b>		
Max. efficiency / European weighted efficiency	97% / 96.4%	97% / 96.5%
<b>Protective devices</b>		
DC disconnect device	●	●
Ground fault monitoring / grid monitoring	● / ●	● / ●
DC reverse polarity protection / AC short-circuit current capability / galvanically isolated	● / ● / -	● / ●
All-pole-sensitive residual-current monitoring unit	●	●
Protection class (according to IEC 62103) / overvoltage category (according to IEC 60664-1)	I / III	I / III
<b>General data</b>		
Dimensions (W / H / D)	490 / 519 / 185 mm (19.3 / 20.4 / 7.3 inch)	490 / 519 / 185 mm (19.3 / 20.4 / 7.3 inch)
Weight	26 kg / 57.3 lb	26 kg / 57.3 lb
Operating temperature range	-25 °C ... +60 °C / -13 °F ... +140 °F	-25 °C ... +60 °C / -13 °F ... +140 °F
Noise emission (typical)	25 dB(A)	25 dB(A)
Self-consumption (night)	1 W	1 W
Topology	Transformerless	Transformerless
Cooling concept	Convection	Convection
Degree of protection (according to IEC 60529)	IP65	IP65
Degree of protection of connection area (according to IEC 60529)	IP54	IP54
Climatic category (according to IEC 60721-3-4)	4K4H	4K4H
Max. permissible value for relative humidity (non-condensing)	100 %	100 %
<b>Features</b>		
DC connection	SUNCLIX	SUNCLIX
AC connection	Spring clamp terminal	Spring clamp terminal
Display	Graphic	Graphic
Interface: RS485 / Bluetooth / multi-function relay	○ / ● / ●	○ / ● / ●
Warranty: 5 / 10 / 15 / 20 / 25 years	● / ○ / ○ / ○ / ○	● / ○ / ○ / ○ / ○
Certificates and approvals (more available on request)	CE, VDE0126-1-1, C10/11, VDE-AR-N 4105	
Certificates and approvals (planned)	G83/1-1, RD 661/2007, PPC, AS 4777, EN 50438 <sup>1</sup> , MEA, PPDS, IEC 61727, SI4777, UTE C15-712-1, G59/2, CEI 0-21, RD1699	
Type designation	SB 4000TL-21	SB 5000TL-21



#### Efficient

- Efficiency of up to 96 %
- Transformerless

#### Reliable

- Integrated ESS DC switch-disconnector (optional)

#### Reliable

- Proven technology
- Maintenance free, thanks to convection cooling

#### Simple

- SUNCLIX DC plug-in system



## SUNNY BOY 1600TL / 2100TL

Small inverters with big results

Combining a broad input voltage range and a broad input current range, the transformerless Sunny Boy can be connected to nearly all standard crystalline PV modules. As a proven entry-level device in the field of transformerless inverters, it offers top-class efficiency. Its low weight and robust enclosure allow simple installation, both indoors and outdoors. With its two power classes, it is the ideal inverter for smaller PV plants.

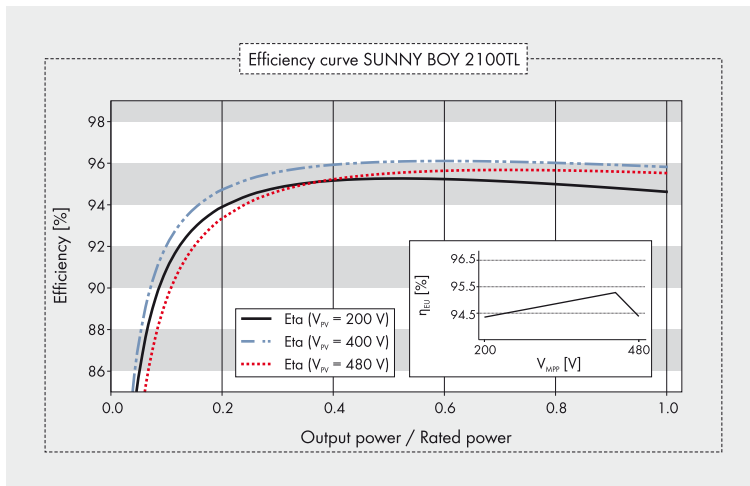

Accessories



RS485 interface  
485PB-NR



Bluetooth  
Piggy-Back BTPBINV-NR

<sup>1</sup> Does not apply to all national appendices of EN 50438

● Standard feature ○ Optional feature – Not available  
Data at nominal conditions

Technical data	Sunny Boy 1600TL	Sunny Boy 2100TL
<b>Input (DC)</b>		
Max. DC power (@ cos φ = 1)	1700 W	2200 W
Max. input voltage	600 V	600 V
MPP voltage range / rated input voltage	155 V - 480 V / 400 V	200 V - 480 V / 400 V
Min. input voltage / initial input voltage	125 V / 150 V	125 V / 150 V
Max. input current	11 A	11 A
Max. input current per string	11 A	11 A
Number of independent MPP inputs / strings per MPP input	1 / 1	1 / 2
<b>Output (AC)</b>		
Rated power (@ 230 V, 50 Hz)	1600 W	1950 W
Max. apparent AC power	1600 VA	2100 VA
Nominal AC voltage / range	220 V, 230 V, 240 V / 180 V - 260 V	220 V, 230 V, 240 V / 180 V - 260 V
AC power frequency / range	50 Hz / -4.5 Hz ... +2.5 Hz	50 Hz / -4.5 Hz ... +2.5 Hz
Rated power frequency / rated grid voltage	50 Hz / 230 V	50 Hz / 230 V
Max. output current	8.9 A	11 A
Power factor at rated power	1	1
Feed-in phases / connection phases	1 / 1	1 / 1
<b>Efficiency</b>		
Max. efficiency / European weighted efficiency	96 % / 95 %	96 % / 95.2 %
<b>Protective devices</b>		
DC disconnect device	○	○
Ground fault monitoring / grid monitoring	● / ●	● / ●
DC reverse polarity protection / AC short-circuit current capability / galvanically isolated	● / ● / -	● / ● / -
All-pole-sensitive residual-current monitoring unit	●	●
Protection class (according to IEC 62103) / overvoltage category (according to IEC 60664-1)	I / III	I / III
<b>General data</b>		
Dimensions (W / H / D)	440 / 339 / 214 mm (17.3 / 13.4 / 8.4 inch)	440 / 339 / 214 mm (17.3 / 13.4 / 8.4 inch)
Weight	16 kg / 35.3 lb	16 kg / 35.3 lb
Operating temperature range	-25 °C ... +60 °C / -13 °F ... +140 °F	-25 °C ... +60 °C / -13 °F ... +140 °F
Noise emission (typical)	33 dB(A)	33 dB(A)
Self-consumption (night)	0.1 W	0.1 W
Topology	Transformerless	Transformerless
Cooling concept	Convection	Convection
Degree of protection (according to IEC 60529)	IP65	IP65
Degree of protection of connection area (according to IEC 60529)	IP65	IP65
Climatic category (according to IEC 60721-3-4)	4K4H	4K4H
Max. permissible value for relative humidity (non-condensing)	100 %	100 %
<b>Features</b>		
DC connection	SUNCLIX	SUNCLIX
AC connection	Connector	Connector
Display	Text line	Text line
Interface: RS485 / Bluetooth	○ / ○	○ / ○
Warranty: 5 / 10 / 15 / 20 / 25 years	● / ○ / ○ / ○ / ○	● / ○ / ○ / ○ / ○
Certificates and approvals (more available on request)	CE, VDE0126-1-1, G83/1-1, PPC, AS 4777, EN 50438 <sup>1</sup> , C10/11, PPDS, UTE C15-712-1, VDE-AR-N 4105, RD1699 CEI 0-21	
Certificates and approvals (planned)		
Type designation	SB 1600TL-10	SB 2100TL



**NOW AVAILABLE FOR 240 V**

#### **Innovative**

- First transformerless SMA inverter to be certified in accordance with UL 1741 with safety standards from IEC 62109
- First inverter with arc-fault circuit interrupter listed according to UL1699B

#### **Economical**

- Maximum efficiency of 98.3%
- The best MPP tracking efficiency with OptiTrac MPP tracking
- Transformerless, with H5 topology
- OptiCool active temperature management

#### **Reliable**

- Integrated DC switch-disconnector
- SMA Power Balancer for three-phase grid connection
- With arc-fault circuit interrupter (AFCI)



## **SUNNY BOY 6000TL-US / 7000TL-US / 8000TL-US / 9000TL-US / 10000TL-US / 11000TL-US**

High yield providers with UL listing

With peak efficiencies of 98.3%, the transformerless Sunny Boy TL-US provide their owners with high yields. The power classes, finely tiered from 6 kW to 11kW, are ideal for designing mid-size solar power plants with precision. Its reduces weight, together with its security features, make our Sunny Boy the ideal inverter.



Technical data	Sunny Boy 6000TL-US 240 V	Sunny Boy 7000TL-US 240 V
<b>Input (DC)</b>		
Max. recommended PV power (@ module STC)	7500 W	8750 W
Max. DC power (@ $\cos \varphi = 1$ )	6200 W	7300 W
Max. input voltage	600 V	600 V
MPP voltage range / rated input voltage	345 V - 480 V / 379 V	345 V - 480 V / 379 V
Min. input voltage / initial input voltage	345 V / 360 V	345 V / 360 V
Max. input current	18.1 A	21.1 A
Max. input current per string	18.1 A	21.1 A
Number of independent MPP inputs	1	1
Strings per MPP input @ Combiner Box	6	6
<b>Output (AC)</b>		
Rated power / max. apparent AC power	6000 W / 6000 VA	7000 W / 7000 VA
Nominal AC voltage / nominal AC voltage range	240 V / 211 V - 264 V	240 V / 211 V - 264 V
AC power frequency / range	60 Hz / 59.3 Hz ... 60.5 Hz	60 Hz / 59.3 Hz ... 60.5 Hz
Max. output current	25 A	29.2 A
Power factor at rated power	1	1
Feed-in phases / connection phases	1 / 2	1 / 2
<b>Efficiency</b>		
CEC efficiency / max. efficiency	98.3 % / 98 %	98.3 % / 98 %
<b>Protective devices</b>		
DC reverse polarity protection	●	●
AC short-circuit current capability	●	●
Galvanic isolation	–	–
All-pole-sensitive residual-current monitoring unit	●	●
Arc-fault circuit interrupter (according to UL 1699B)	●	●
Protection class (according to IEC 62103)	I	I
Overvoltage category (according to IEC 60664-1)	IV	IV
<b>General data</b>		
Dimensions (W / H / D)	467 / 838 / 241 mm (18.4 / 24.1 / 9.5 inch)	467 / 838 / 241 mm (18.4 / 24.1 / 9.5 inch)
Dimensions of DC Disconnect (W / H / D)	187 / 297 / 190 mm (7.28 / 11.7 / 7.5 inch)	187 / 297 / 190 mm (7.28 / 11.7 / 7.5 inch)
Weight	35 kg / 78 lb	35 kg / 78 lb
Weight of DC Disconnect	3.5 kg / 8 lb	3.5 kg / 8 lb
Operating temperature range	-40 °C ... +60 °C / -40 °F ... +140 °F	-40 °C ... +60 °C / -40 °F ... +140 °F
Noise emission (typical)	46 dB(A)	46 dB(A)
Self-consumption (night)	0.15 W	0.15 W
Topology	Transformerless H5	Transformerless H5
Cooling concept	OptiCool	OptiCool
Degree of protection	NEMA 3R	NEMA 3R
Degree of protection of connection area	NEMA 3R	NEMA 3R
Max. permissible value for relative humidity (non-condensing)	100 %	100 %
<b>Features</b>		
DC connection	Screw terminal	Screw terminal
AC connection	Screw terminal	Screw terminal
Display	Text line	Text line
Interface: RS485 / Bluetooth	○ / ○	○ / ○
Warranty: 10 / 15 / 20 years	● / ○ / ○	● / ○ / ○
Certificates and approvals (more available on request)	UL1741, UL1998, IEE1547, FCC Part 15 (Class A & B), CAN/CSA C22.2 107.1-1, UL 1699B	
Type designation	SB 6000TLUS-12	SB 7000TLUS-12

# SUNNY BOY 6000TL-US / 7000TL-US / 8000TL-US / 9000TL-US / 10000TL-US / 11000TL-US

Technical data	Sunny Boy 8000TL-US 208 V	Sunny Boy 8000TL-US 240 V
<b>Input (DC)</b>		
Max. recommended PV power (@ module STC)	10000 W	10000 W
Max. DC power (@ $\cos \varphi = 1$ )	8,400 W	8300 W
Max. input voltage	600 V	600 V
MPP voltage range / rated input voltage	300 V - 480 V / 345 V	345 V - 480 V / 379 V
Min. input voltage / initial input voltage	300 V / 360 V	345 V / 360 V
Max. input current	27.9 A	24.1 A
Max. input current per string	27.9 A	24.1 A
Number of independent MPP inputs	1	1
Strings per MPP input @ Combiner Box	6	6
<b>Output (AC)</b>		
Rated power / max. apparent AC power	8,000 W/8,100 V A	
Nominal AC voltage / nominal AC voltage range	208 V / 183 V - 229 V	240 V / 211 V - 264 V
AC power frequency / range	60 Hz / 59.3 Hz ... 60.5 Hz	60 Hz / 59.3 Hz ... 60.5 Hz
Max. output current	38.5 A	33.4 A
Power factor at rated power	1	
Feed-in phases / connection phases	1 / 2	
<b>Efficiency</b>		
CEC efficiency / max. efficiency	98 % / 98.3 %	98 % / 98.3 %
<b>Protective devices</b>		
DC reverse polarity protection	●	
AC short-circuit current capability	●	
Galvanic isolation	-	
All-pole-sensitive residual-current monitoring unit	●	
Arc-fault circuit interrupter (according to UL 1699B)	●	
Protection class (according to IEC 62103)	I	
Overvoltage category (according to IEC 60664-1)	IV	
<b>General data</b>		
Dimensions (W / H / D)	467 / 838 / 241 mm (18.4 / 24.1 / 9.5 inch)	
Dimensions of DC Disconnect (W / H / D)	187 / 297 / 190 mm (7.28 / 11.7 / 7.5 inch)	
Weight	35 kg / 78 lb	
Weight of DC Disconnect	3.5 kg / 8 lb	
Operating temperature range	-40 °C ... +60 °C / -40 °F ... +140 °F	
Noise emission (typical)	46 dB(A)	
Self-consumption (night)	0.15 W	
Topology	Transformerless H5	
Cooling concept	OptiCool	
Degree of protection	NEMA 3R	
Degree of protection of connection area	NEMA 3R	
Max. permissible value for relative humidity (non-condensing)	100 %	
<b>Features</b>		
DC connection	Screw terminal	
AC connection	Screw terminal	
Display	Text line	
Interface: RS485 / Bluetooth	○ / ○	
Warranty: 10 / 15 / 20 years	● / ○ / ○	
Certificates and approvals (more available on request)	UL1741, UL1998, IEEE1547, FCC Part 15 (Class A & B), CAN/CSA C22.2 107.1-1, UL 1699B	
Type designation	SB 8000TLUS-12	

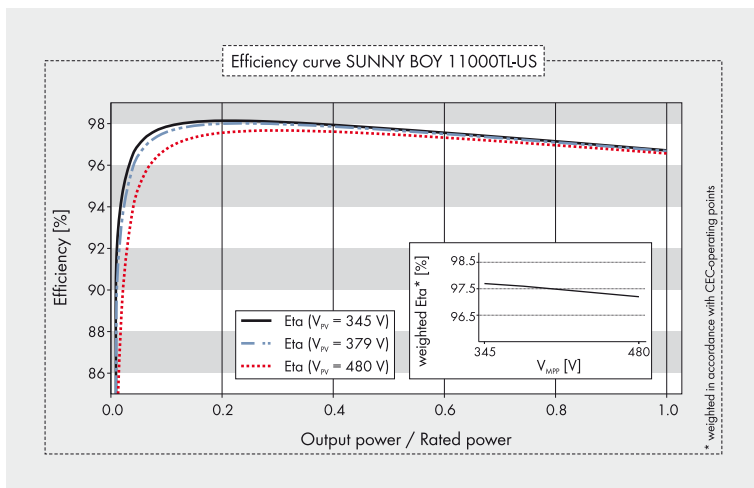

Accessories



Sunny Boy Combiner Box SBCBT6-10



Bluetooth Piggy-Back BTPBINV-NR



Interface RS485 485USPB-SMC-NR



SMA Power Balancer Set PBL5BUS-10-NR

● Standard feature ○ Optional feature – Not available  
Data at nominal conditions

Sunny Boy 9000TL-US 208 V	Sunny Boy 9000TL-US 240 V	Sunny Boy 10000TL-US 208 V	Sunny Boy 10000TL-US 240 V	Sunny Boy 11000TL-US 240 V
11,250 W	12500 W	12500 W	12500 W	13750 W
9400 W	10400 W	10500 W	10350 W	11500 W
600 V	600 V	600 V	600 V	600 V
300 V - 480 V / 345 V	345 V - 480 V / 379 V	300 V - 480 V / 345 V	345 V - 480 V / 379 V	345 V - 480 V / 379 V
300 V / 360 V	345 V / 360 V	300 V / 360 V	345 V / 360 V	345 V / 360 V
31.4 A	30.2 A	35 A	30.2 A	33.3 A
31.4 A	30.2 A	35 A	30.2 A	33.3 A
1	1	1	1	1
6	6	6	6	6
9000 W / 900 VA		10000 W / 10000 VA		11000 W / 11000 VA
208 V / 183 V - 229 V	240 V / 211 V - 264 V	208 V / 183 V - 229 V	240 V / 211 V - 264 V	240 V / 211 V - 264 V
60 Hz / 59.3 Hz ... 60.5 Hz	60 Hz / 59.3 Hz ... 60.5 Hz	60 Hz / 59.3 Hz ... 60.5 Hz	60 Hz / 59.3 Hz ... 60.5 Hz	60 Hz / 59.3 Hz ... 60.5 Hz
43.3 A	41.7 A	48.1 A	41.7 A	45.8 A
	1		1	1
	1 / 2		1 / 2	1 / 2
98 % / 98.3 %	98 % / 98.3 %	98 % / 98.3 %	98 % / 98.3 %	98 % / 98.3 %
●	●	●	●	●
●	●	●	●	●
–	–	–	–	–
●	●	●	●	●
●	●	●	●	●
I	I	I	I	I
IV	IV	IV	IV	IV
470 / 615 / 240 mm (18.4 / 24.1 / 9.5 inch)		187 / 297 / 190 mm (7.28 / 11.7 / 7.5 inch)		
35 kg / 78 lb		3.5 kg / 8 lb		
-40 °C ... +60 °C / -40 °F ... +140 °F				
46 dB(A)	46 dB(A)	46 dB(A)	46 dB(A)	46 dB(A)
0.15 W	0.15 W	0.15 W	0.15 W	0.15 W
Transformerless H5	Transformerless H5	Transformerless H5	Transformerless H5	Transformerless H5
OptiCool	OptiCool	OptiCool	OptiCool	OptiCool
NEMA 3R	NEMA 3R	NEMA 3R	NEMA 3R	NEMA 3R
NEMA 3R	NEMA 3R	NEMA 3R	NEMA 3R	NEMA 3R
100 %	100 %	100 %	100 %	100 %
Screw terminal	Screw terminal	Screw terminal	Screw terminal	Screw terminal
Screw terminal	Screw terminal	Screw terminal	Screw terminal	Screw terminal
Text line	Text line	Text line	Text line	Text line
○ / ○	○ / ○	○ / ○	○ / ○	○ / ○
● / ○ / ○	● / ○ / ○	● / ○ / ○	● / ○ / ○	● / ○ / ○
UL1741, UL1998, IEEE1547, FCC Part 15 (Class A & B), CAN/CSA C22.2 107.1-1, UL 1699B				
SB 9000TLUS-12		SB 10000TLUS-12		SB 11000TLUS-12



# INVERTERS WITH TRANSFORMERS







#### Efficient

- OptiCool active temperature management
- The best MPP tracking efficiency with OptiTrac MPP tracking

#### Reliable

- Galvanic isolation
- Integrated ESS DC switch-disconnector
- SMA Power Balancer for three-phase grid connection

#### Flexible

- Integrated reactive power capability and grid management functions
- Input voltage range of up to 800 V
- Suitable for PV array grounding

#### Simple

- SUNCLIX DC plug-in system



## SUNNY MINI CENTRAL 7000HV

The champion for thin-film projects

More modules can be connected in series with the Sunny Mini Central 7000HV than with common inverters. This reduces cabling costs on the DC side and simplifies the installation. Due to its galvanic isolation, the device can be used both with crystalline cells and thin-film PV modules. Its performance range allows the installation of large PV arrays using smaller string inverters, resulting in more detailed PV plant monitoring. Its new reactive power and grid management functions mean it is also suitable for demanding applications.

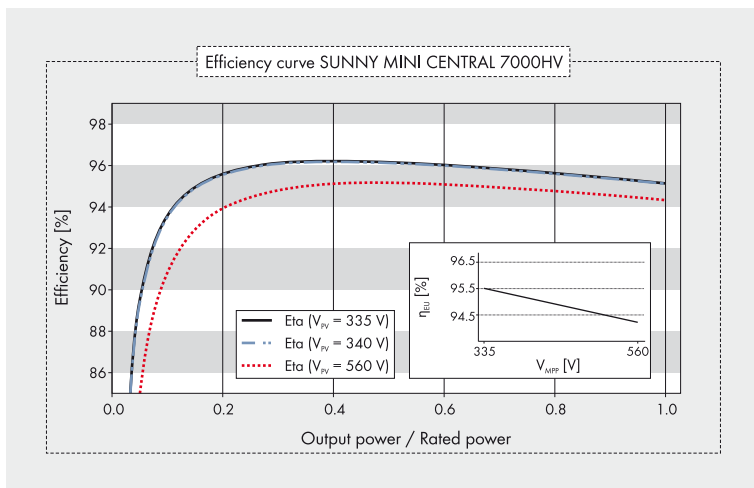

Accessories



RS485 interface  
485PB-SMC-NR



Bluetooth  
Piggy-Back BTPBINV-NR



SMA Power Balancer  
plug-in system  
PBL-SMC-10-NR



Grounding set "positive"  
ESHV-P-NR



Grounding set "negative"  
ESHV-N-NR

<sup>1</sup> Does not apply to all national appendices of EN 50438

Technical data	Sunny Mini Central 7000HV	
<b>Input (DC)</b>		
Max. DC power (@ cos φ = 1)	7500 W	
Max. input voltage	800 V	
MPP voltage range / rated input voltage	335 V - 560 V / 340 V	
Min. input voltage / initial input voltage	290 V / 400 V	
Max. input current	23 A	
Max. input current per string	23 A	
Number of independent MPP inputs / strings per MPP input	1 / 4	
<b>Output (AC)</b>		
Rated power (@ 230 V, 50 Hz)	6650 W	
Max. apparent AC power	7000 VA	
Nominal AC voltage / range	220 V, 230 V, 240 V / 160 V - 265 V	
AC power frequency / range	50 Hz, 60 Hz / -6 Hz ... +5 Hz	
Rated power frequency / rated grid voltage	50 Hz / 230 V	
Max. output current	31 A	
Power factor at rated power	1	
Adjustable displacement power factor	0.8 overexcited ... 0.8 underexcited	
Feed-in phases / connection phases	1 / 1	
Power balancing	●	
<b>Efficiency</b>		
Max. efficiency / European weighted efficiency	96.2 % / 95.5 %	
<b>Protective devices</b>		
DC disconnect device	●	
Ground fault monitoring / grid monitoring	● / ●	
DC reverse polarity protection / AC short-circuit current capability / galvanically isolated	● / ● / ●	
Protection class (according to IEC 62103) / overvoltage category (according to IEC 60664-1)	I / III	
<b>General data</b>		
Dimensions (W / H / D)	468 / 613 / 242 mm (18.4 / 24.1 / 9.5 inch)	
Weight	65 kg / 143.3 lb	
Operating temperature range	-25 °C ... +60 °C / -13 °F ... +140 °F	
Noise emission (typical)	41 dB(A)	
Self-consumption (night)	0.25 W	
Topology	LF transformer	
Cooling concept	OptiCool	
Degree of protection (according to IEC 60529)	IP65	
Degree of protection of connection area (according to IEC 60529)	IP65	
Climatic category (according to IEC 60721-3-4)	4K4H	
Max. permissible value for relative humidity (non-condensing)	100 %	
<b>Features</b>		
DC connection	SUNCLIX	
AC connection	Screw terminal	
Display	Text line	
Interface: RS485 / Bluetooth	○ / ○	
Warranty: 5 / 10 / 15 / 20 / 25 years	● / ○ / ○ / ○ / ○	
Certificates and approvals (more available on request)	CE, VDE0126-1-1, RD 661/2007, PPC, AS 4777, AR4105, EN 50438 <sup>1</sup> , C10/11, PPDS, IEC 61727, UTE C15-712-1, G59/2, RD1699	
● Standard feature ○ Optional feature – Not available, data at nominal conditions		
Type designation	SMC 7000HV-11	



#### Powerful

- OptiCool active temperature management
- The best MPP tracking efficiency with OptiTrac MPP tracking

#### Reliable

- Galvanic isolation
- Integrated ESS DC switch-disconnector
- SMA Power Balancer for three-phase grid connection

#### Flexible

- Suitable for PV array grounding
- Integrated grid management functions with reactive power provision

#### Simple

- SUNCLIX DC plug-in system



## SUNNY MINI CENTRAL 4600A / 5000A / 6000A

Proven technology for a multitude of applications

The Sunny Mini Central 4600A, 5000A and 6000A are installed wherever galvanic isolation is required. This means they can be universally used for many different types of connections, e.g. with crystalline cells as well as with thin-film modules. The Sunny Mini Central 5000A and 6000A are also ideal for three-phase systems in combination with the SMA Power Balancer, while the Sunny Mini Central 4600A is designed for single-phase PV plants. Thanks to reactive power provision, they support grid stability, and they are flexible and can be applied to different plant sizes.



Trévoux, France



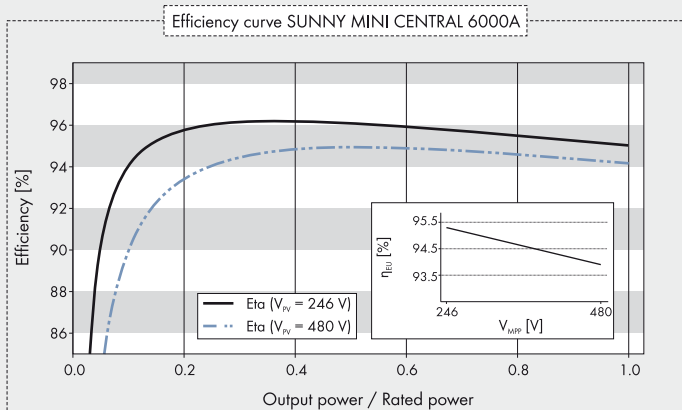

# SUNNY MINI CENTRAL 4600A / 5000A / 6000A

Technical data	Sunny Mini Central 4600A	
<b>Input (DC)</b>		
Max. DC power (@ $\cos \varphi = 1$ )	5250 W	
Max. input voltage	600 V	
MPP voltage range / rated input voltage	246 V - 480 V / 246 V	
Min. input voltage / initial input voltage	211 V / 300 V	
Max. input current	26 A	
Max. input current per string	26 A	
Number of independent MPP inputs / strings per MPP input	1 / 4	
<b>Output (AC)</b>		
Rated power (@ 230 V, 50 Hz)	4600 W	
Max. apparent AC power	5000 VA <sup>2</sup>	
Nominal AC voltage / range	220 V, 230 V, 240 V / 160 V - 265 V	
AC power frequency / range	50 Hz, 60 Hz / -6 Hz ... 5 Hz	
Rated power frequency / rated grid voltage	50 Hz / 230 V	
Max. output current	26 A	
Power factor at rated power	1	
Adjustable displacement power factor	0.8 overexcited ... 0.8 underexcited	
Feed-in phases / connection phases	1 / 1	
Power balancing	●	
<b>Efficiency</b>		
Max. efficiency / European weighted efficiency	96.1 % / 95.3 %	
<b>Protective devices</b>		
DC disconnect device	●	
Ground fault monitoring / grid monitoring	● / ●	
DC reverse polarity protection / AC short-circuit current capability / galvanically isolated	● / ● / ●	
Protection class (according to IEC 62103) / overvoltage category (according to IEC 60664-1)	I / III	
<b>General data</b>		
Dimensions (W / H / D)	468 / 613 / 242 mm (18.4 / 24.1 / 9.5 inch)	
Weight	62 kg / 136.69 lb	
Operating temperature range	-25 °C ... +60 °C / -13 °F ... +140 °F	
Noise emission (typical)	42 dB(A)	
Self-consumption (night)	0.25 W	
Topology	LF transformer	
Cooling concept	OptiCool	
Degree of protection (according to IEC 60529)	IP65	
Degree of protection of connection area (according to IEC 60529)	IP65	
Climatic category (according to IEC 60721-3-4)	4K4H	
Max. permissible value for relative humidity (non-condensing)	100 %	
<b>Features</b>		
DC connection	SUNCLIX	
AC connection	Screw terminal	
Display	Text line	
Interface: RS485 / Bluetooth	○ / ○	
Warranty: 5 / 10 / 15 / 20 / 25 years	● / ○ / ○ / ○ / ○	
Certificates and approvals (more available on request)	CE, VDE0126-1-1, VDE-ARN 4105, C10/11, PPDS, UTE C15-712-1, PPC, EN 50438 <sup>1</sup> , RD1699, RD 661/2007	
<p>● Standard feature   ○ Optional feature   – Not available, data at nominal conditions</p>		
Type designation	SMC 4600A-11	





Accessories

- 
RS485 interface  
485PB-SMC-NR
- 
Bluetooth  
Piggy-Back BTPBINV-NR
- 
SMA Power Balancer  
plug-in system  
PBL-SMC-10-NR
- 
Grounding set "positive"  
ESHV-P-NR
- 
Grounding set "negative"  
ESHV-N-NR

<sup>1</sup> Does not apply to all national appendices of EN 50438

<sup>2</sup> 4600 A with VDE-AR-N 4105

Technical data	Sunny Mini Central 5000A	Sunny Mini Central 6000A
<b>Input (DC)</b>		
Max. DC power (@ cos φ = 1)	5750 W	6300 W
Max. input voltage	600 V	600 V
MPP voltage range / rated input voltage	246 V - 480 V / 246 V	246 V - 480 V / 246 V
Min. input voltage / initial input voltage	211 V / 300 V	211 V / 300 V
Max. input current	26 A	26 A
Max. input current per string	26 A	26 A
Number of independent MPP inputs / strings per MPP input	1 / 4	1 / 4
<b>Output (AC)</b>		
Rated power (@ 230 V, 50 Hz)	5000 W	6000 W
Max. apparent AC power	5500 VA	6000 VA
Nominal AC voltage / range	220 V, 230 V, 240 V / 160 V - 265 V	220 V, 230 V, 240 V / 160 V - 265 V
AC power frequency / range	50 Hz, 60 Hz / -6 Hz ... +5 Hz	50 Hz, 60 Hz / -6 Hz ... +5 Hz
Rated power frequency / rated grid voltage	50 Hz / 230 V	50 Hz / 230 V
Max. output current	26 A	26 A
Power factor at rated power	1	1
Adjustable displacement power factor	0.8 overexcited ... 0.8 underexcited	0.8 overexcited ... 0.8 underexcited
Feed-in phases / connection phases	1 / 1	1 / 1
Power balancing	●	●
<b>Efficiency</b>		
Max. efficiency / European weighted efficiency	96.1 % / 95.3 %	96.1 % / 95.4 %
<b>Protective devices</b>		
DC disconnect device	●	●
Ground fault monitoring / grid monitoring	● / ●	● / ●
DC reverse polarity protection / AC short-circuit current capability / galvanically isolated	● / ● / ●	● / ● / ●
Protection class (according to IEC 62103) / overvoltage category (according to IEC 60664-1)	I / III	I / III
<b>General data</b>		
Dimensions (W / H / D)	468 / 613 / 242 mm (18.4 / 24.1 / 9.5 inch)	468 / 613 / 242 mm (18.4 / 24.1 / 9.5 inch)
Weight	62 kg / 136.69 lb	63 kg / 138.89 lb
Operating temperature range	-25 °C ... +60 °C / -13 °F ... +140 °F	-25 °C ... +60 °C / -13 °F ... +140 °F
Noise emission (typical)	42 dB(A)	42 dB(A)
Self-consumption (night)	0.25 W	0.25 W
Topology	LF transformer	LF transformer
Cooling concept	OptiCool	OptiCool
Degree of protection (according to IEC 60529)	IP65	IP65
Degree of protection of connection area (according to IEC 60529)	IP65	IP65
Climatic category (according to IEC 60721-3-4)	4K4H	4K4H
Max. permissible value for relative humidity (non-condensing)	100 %	100 %
<b>Features</b>		
DC connection	SUNCLIX	SUNCLIX
AC connection	Screw terminal	Screw terminal
Display	Text line	Text line
Interface: RS485 / Bluetooth	○ / ○	○ / ○
Warranty: 5 / 10 / 15 / 20 / 25 years	● / ○ / ○ / ○ / ○	● / ○ / ○ / ○ / ○
Certificates and approvals (more available on request)	CE, VDE0126-1-1, RD 661/2007, PPC, AS 4777, EN 50438, C10/11, PPDS, IEC 61727, UTE C15-712-1, G59/2, RD1699, VDE-AR-N 4105	CE, VDE0126-1-1, RD 661/2007, PPC, AS 4777, EN 50438, C10/11, PPDS, IEC 61727, UTE C15-712-1, G59/2, RD1699, VDE-AR-N 4105
● Standard feature ○ Optional feature – Not available, data at nominal conditions		
Type designation	SMC 5000A-11	SMC 6000A-11



#### High yields

- Maximum efficiency 96.3 %
- Shade management with OptiTrac Global Peak

#### Reliable

- Galvanic isolation
- Integrated ESS DC switch-disconnector
- Theft protection

#### Simple

- Quick and easy configuration thanks to Quick Module
- SUNCLIX DC plug-in system
- Suitable for PV array grounding

#### Informative

- Simple country configuration
- Graphic display
- Bluetooth as standard



## SUNNY BOY 2000HF / 2500HF / 3000HF

A high yield performer

Packed full of innovative technology, the Sunny Boy HF series provides the highest yields for transformer-based inverters in this power class. Installation is now easier than ever thanks to the SUNCLIX DC plug-in system, the plug-in PV array grounding and an easily accessible configuration area – all in a reduced weight unit. The wide input voltage range from 175 to 700 V gives you extraordinary flexibility for your plant design, and the modern graphic display and wireless *Bluetooth* communication *Bluetooth* make the devices highly user-friendly.



Vieste, Italy

# SUNNY BOY 2000HF / 2500HF / 3000HF

Technical data	Sunny Boy 2000HF	Sunny Boy 2500HF
<b>Input (DC)</b>		
Max. DC power (@ $\cos \varphi = 1$ )	2100 W	2600 W
Max. input voltage	700 V	700 V
MPP voltage range / rated input voltage	175 V - 560 V / 530 V	175 V - 560 V / 530 V
Min. input voltage / initial input voltage	175 V / 220 V	175 V / 220 V
Max. input current	12 A	15 A
Max. input current per string	12 A	15 A
Number of independent MPP inputs / strings per MPP input	1 / 2	1 / 2
<b>Output (AC)</b>		
Rated power (@ 230 V, 50 Hz)	2000 W	2500 W
Max. apparent AC power	2000 VA	2500 VA
Nominal AC voltage / range	220 V, 230 V, 240 V / 180 V - 280 V	220 V, 230 V, 240 V / 180 V - 280 V
AC power frequency / range	50 Hz, 60 Hz / -4.5 Hz ... +4.5 Hz	50 Hz, 60 Hz / -4.5 Hz ... +4.5 Hz
Rated power frequency / rated grid voltage	50 Hz / 230 V	50 Hz / 230 V
Max. output current	11.4 A	14.2 A
Power factor at rated power	1	1
Feed-in phases / connection phases	1 / 1	1 / 1
<b>Efficiency</b>		
Max. efficiency / European weighted efficiency	96.3% / 95%	96.3% / 95.3%
<b>Protective devices</b>		
DC disconnect device	●	●
Ground fault monitoring / grid monitoring	● / ●	● / ●
DC reverse polarity protection / AC short-circuit current capability / galvanically isolated	● / ● / ●	● / ● / ●
Protection class (according to IEC 62103) / overvoltage category (according to IEC 60664-1)	I / III	I / III
<b>General data</b>		
Dimensions (W / H / D)	348 / 580 / 145 mm (13.7 / 22.8 / 5.7 inch)	348 / 580 / 145 mm (13.7 / 22.8 / 5.7 inch)
Weight	17 kg / 37.4 lb	17 kg / 37.4 lb
Operating temperature range	-25 °C ... +60 °C / -13 °F ... +140 °F	-25 °C ... +60 °C / -13 °F ... +140 °F
Noise emission (typical)	38 dB(A)	38 dB(A)
Self-consumption (night)	1 W	1 W
Topology	HF transformer	HF transformer
Cooling concept	Convection	OptiCool
Degree of protection (according to IEC 60529)	IP65	IP65
Degree of protection of connection area (according to IEC 60529)	IP54	IP54
Climatic category (according to IEC 60721-3-4)	4K4H	4K4H
Max. permissible value for relative humidity (non-condensing)	100 %	100 %
<b>Features</b>		
DC connection	SUNCLIX	SUNCLIX
AC connection	Connector	Connector
Display	Graphic	Graphic
Interface: RS485 / Bluetooth	○ / ●	○ / ●
Warranty: 5 / 10 / 15 / 20 / 25 years	● / ○ / ○ / ○ / ○ / ○	● / ○ / ○ / ○ / ○ / ○
Multi-function relay	○	○
Certificates and approvals (more available on request)	CE, VDE0126-1-1, G83/1-1, PPC, AS 4777, EN 50438 <sup>1</sup> , C10/11, PPDS, IEC 61727, SI4777, UTE C15-712-1, VDE-AR-N 4105, RD1699	
Type designation	SB 2000HF-30	SB 2500HF-30

Efficiency curve SUNNY BOY 3000HF

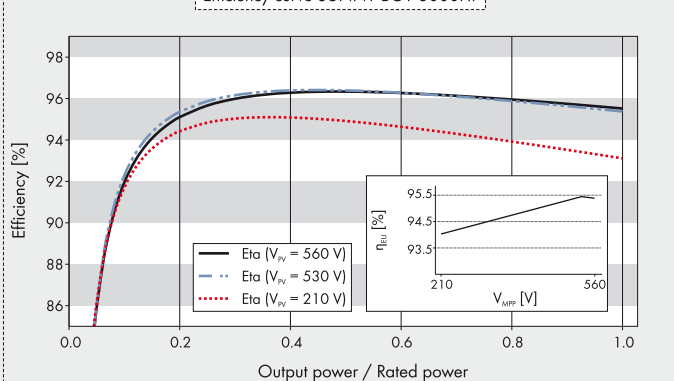

Accessories



SMA plug-in  
PV array grounding  
PLUGIN-GRD-10-NR\*



Quick Module RS485 +  
multi-function relay  
485QM-10-NR

<sup>1</sup> Does not apply to all national appendices of EN 50438

<sup>2</sup> Applies to V variant only

● Standard feature ○ Optional feature – Not available

Data at nominal conditions

Technical data	Sunny Boy 3000HF	
<b>Input (DC)</b>		
Max. DC power (@ cos φ = 1)	3150 W	
Max. input voltage	700 V	
MPP voltage range / rated input voltage	210 V - 560 V / 530 V	
Min. input voltage / initial input voltage	175 V / 220 V	
Max. input current	15 A	
Max. input current per string	15 A	
Number of independent MPP inputs / strings per MPP input	1 / 2	
<b>Output (AC)</b>		
Rated power (@ 230 V, 50 Hz)	3000 W	
Max. apparent AC power	3000 VA	
Nominal AC voltage / range	220 V, 230 V, 240 V / 180 V - 280 V	
AC power frequency / range	50 Hz, 60 Hz / -4.5 Hz ... +4.5 Hz	
Rated power frequency / rated grid voltage	50 Hz / 230 V	
Max. output current	15 A	
Power factor at rated power	1	
Feed-in phases / connection phases	1 / 1	
<b>Efficiency</b>		
Max. efficiency / European weighted efficiency	96.3 % / 95.4 %	
<b>Protective devices</b>		
DC disconnect device	●	
Ground fault monitoring / grid monitoring	● / ●	
DC reverse polarity protection / AC short-circuit current capability / galvanically isolated	● / ● / ●	
Protection class (according to IEC 62103) / overvoltage category (according to IEC 60664-1)	I / III	
<b>General data</b>		
Dimensions (W / H / D)	348 / 580 / 145 mm (13.7 / 22.8 / 5.7 inch)	
Weight	17 kg / 37.4 lb	
Operating temperature range	-25 °C ... +60 °C / -13 °F ... +140 °F	
Noise emission (typical)	38 dB(A)	
Self-consumption (night)	1 W	
Topology	HF transformer	
Cooling concept	OptiCool	
Degree of protection (according to IEC 60529)	IP65	
Degree of protection of connection area (according to IEC 60529)	IP54	
Climatic category (according to IEC 60721-3-4)	4K4H	
Max. permissible value for relative humidity (non-condensing)	100 %	
<b>Features</b>		
DC connection	SUNCLIX	
AC connection	Connector	
Display	Graphic	
Interface: RS485 / Bluetooth	○ / ●	
Warranty: 5 / 10 / 15 / 20 / 25 years	● / ○ / ○ / ○ / ○ / ○	
Multi-function relay	○	
Certificates and approvals (more available on request)	CE, VDE0126-1-1, G83/1-1, PPC, AS 4777, EN 50438 <sup>1</sup> , C10/11, PPDS, KEMCO <sup>2</sup> , IEC 61727, SI4777, UTE C15-712-1, VDE-AR-N 4105, RD1699	
Type designation	SB 3000HF-30	





#### UL listed

- For countries that require UL listing (UL 1741 / IEEE 1547 / CAN CSA C22.2 107)

#### Economical

- 97 % peak efficiency
- OptiCool active temperature management

#### Reliable

- Galvanic isolation
- Arc-fault circuit interrupter, optional (AFCI)

#### Simple

- Automatic grid voltage detection<sup>1</sup>
- Integrated DC switch-disconnector



## SUNNY BOY 5000-US / 6000-US / 7000-US / 8000-US

Versatile performer with UL listing

Maximum energy yields for a continuously expanding photovoltaic market: the Sunny Boys with UL listing is impressive with its excellent efficiency. Graduated power classes provide flexibility in plant planning. The automatic grid voltage detection<sup>1</sup> allows easy and safe installation. Furthermore, the galvanic isolation provides flexible connection possibilities. The Sunny Boy inverters can be used with crystalline cells as well as thin-film PV modules.

<sup>1</sup> US patent US7352549B1

<sup>2</sup> SB 5000US-12 / SB 6000US-12 / SB 7000US-12 / SB 8000US-12 also available with arc-fault circuit interrupter and operating temperature from -40 °C to +45 °C / -40 °F to +113 °F

Technical data	Sunny Boy 5000-US 208 V	Sunny Boy 5000-US 240 V	Sunny Boy 5000-US 277 V
<b>Input (DC)</b>			
Max. recommended PV power (@ module STC)		6250 W	
Max. DC power (@ $\cos \varphi = 1$ )		5300 W	
Max. input voltage		600 V	
MPP voltage range / rated input voltage		250 V – 480 V / 310 V	
Min. input voltage / initial input voltage		250 V / 300 V	
Max. input current		21 A	
Max. string fuse on the DC disconnect		20 A	
Number of independent MPP inputs		1	
Strings per MPP input (@ DC disconnect)		4	
<b>Output (AC)</b>			
Rated power / max. apparent AC power		5000 W / 5000 VA	
Nominal AC voltage / nominal AC voltage range	208 V / 183 V – 229 V	240 V / 211 V – 264 V	277 V / 244 V – 305 V
AC power frequency / range		60 Hz / 59.3 Hz ... 60.5 Hz	
Max. output current	24 A	21 A	18 A
Power factor at rated power		1	
Feed-in phases / connection phases	1 / 2	1 / 2	1 / 1
<b>Efficiency</b>			
CEC efficiency / max. efficiency	95.5 % / 96.7 %	95.5 % / 96.8 %	95.5 % / 96.8 %
<b>Protective devices</b>			
DC reverse polarity protection		●	
AC short-circuit current capability		●	
Galvanically isolated		●	
Arc-fault circuit interrupter (in accordance with UL1699B) <sup>2</sup>		○	
Protection class (according to IEC 62103)		I	
Overvoltage category (according to IEC 60664-1)		III	
<b>General data</b>			
Dimensions (W / H / D)		470 / 615 / 240 mm (18.4 / 24.1 / 9.5 inch)	
Dimensions of DC Disconnect (W / H / D)		187 / 297 / 190 mm (7.3 / 11.7 / 7.5 inch)	
Weight		64 kg / 143 lb	
Weight of DC Disconnect		3.5 kg / 8 lb	
Operating temperature range <sup>2</sup>		-25 °C ... +45 °C / -13 °F ... +113 °F	
Noise emission (typical)		44 dB(A)	
Self-consumption (night)		0.1 W	
Topology		LF transformer	
Cooling concept		OptiCool	
Degree of protection		NEMA 3R	
Degree of protection of connection area		NEMA 3R	
Max. permissible value for relative humidity (non-condensing)		100 %	
<b>Features</b>			
DC connection		Screw terminal	
AC connection		Screw terminal	
Display		Text line	
Interface: RS485 / Bluetooth		○ / ○	
Warranty: 10 / 15 / 20 years		● / ○ / ○	
Certificates and approvals (more available on request)	UL1741, UL1998, IEEE1547, FCC Part 15 (Class A & B), CAN/CSA C22.2 107.1-1, UL 1699B		
Type designation	SB 5000US		

# SUNNY BOY 5000-US / 6000-US / 7000-US / 8000-US

Technical data	Sunny Boy 6000-US 208 V	Sunny Boy 6000-US 240 V	Sunny Boy 6000-US 277 V
<b>Input (DC)</b>			
Max. recommended PV power (@ module STC)	7500 W		
Max. DC power (@ $\cos \varphi = 1$ )	6350 W		
Max. input voltage	600 V		
MPP voltage range / rated input voltage	250 V - 480 V / 310 V		
Min. input voltage / initial input voltage	250 V / 300 V		
Max. input current	25 A		
Max. string fuse on the DC disconnect	20 A		
Number of independent MPP inputs	1		
Strings per MPP input (@ DC disconnect)	4		
<b>Output (AC)</b>			
Rated power / max. apparent AC power	6000 W / 6000 VA		
Nominal AC voltage / nominal AC voltage range	208 V / 183 V - 229 V	240 V / 211 V - 264 V	277 V / 244 V - 305 V
AC power frequency / range	60 Hz / 59.3 Hz ... 60.5 Hz		
Max. output current	29 A	25 A	22 A
Power factor at rated power	1		
Feed-in phases / connection phases	1 / 2	1 / 2	1 / 1
<b>Efficiency</b>			
CEC efficiency / max. efficiency	95.5 % / 96.9 %	95.5 % / 96.8 %	96 % / 97 %
<b>Protective devices</b>			
DC reverse polarity protection	●		
AC short-circuit current capability	●		
Galvanically isolated	●		
Arc-fault circuit interrupter (according to UL 1699B) <sup>1</sup>	○		
Protection class (according to IEC 62103)	I		
Overvoltage category (according to IEC 60664-1)	III		
<b>General data</b>			
Dimensions (W / H / D)	470 / 615 / 240 mm (18.4 / 24.1 / 9.5 inch)		
Dimensions of DC Disconnect (W / H / D)	187 / 297 / 190 mm (7.3 / 11.7 / 7.5 inch)		
Weight	64 kg / 143 lb		
Weight of DC Disconnect	3.5 kg / 8 lb		
Operating temperature range <sup>1</sup>	-25 °C ... +45 °C / -13 °F ... +113 °F		
Noise emission (typical)	45 dB(A)		
Self-consumption (night)	0.1 W		
Topology	LF transformer		
Cooling concept	OptiCool		
Degree of protection	NEMA 3R		
Degree of protection of connection area	NEMA 3R		
Max. permissible value for relative humidity (non-condensing)	100 %		
<b>Features</b>			
DC connection	Screw terminal		
AC connection	Screw terminal		
Display	Text line		
Interface: RS485 / Bluetooth	○ / ○		
Warranty: 10 / 15 / 20 years	● / ○ / ○		
Certificates and approvals (more available on request)	UL1741, UL1998, IEEE1547, FCC Part 15 (Class A & B), CAN/CSA C22.2 107.1-1, C22.2, UL 1699B		
Type designation	SB 6000US		

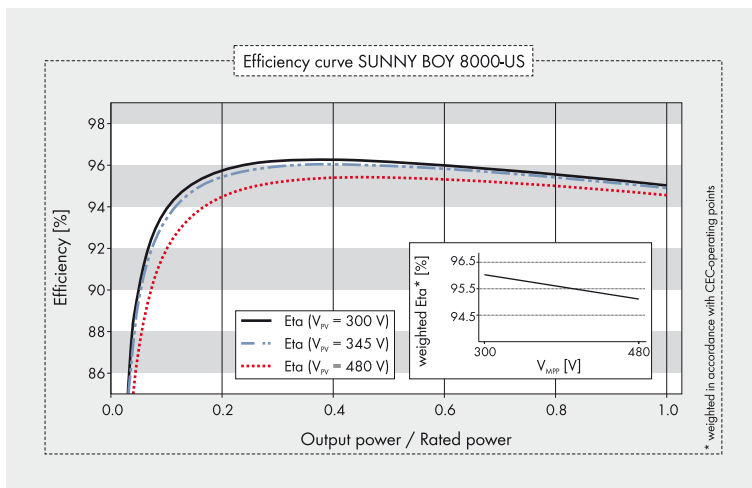

Accessories



Interface RS485  
485USPB-SMC-NR



Bluetooth  
Piggy-Back BTPBINV-NR



SMA Power Balancer Set  
PBL-SBUS-10-NR

<sup>1</sup> SB 5000US-12 / SB 6000US-12 / SB 7000US-12 / SB 8000US-12 also available with arc-fault circuit interrupter and operating temperature from -40 °C to +45 °C / -40 °F to +113 °F

● Standard feature ○ Optional feature – Not available

Data at nominal conditions

Sunny Boy 7000-US 208 V		Sunny Boy 7000-US 240 V		Sunny Boy 7000-US 277 V		Sunny Boy 8000-US 240 V		Sunny Boy 8000-US 277 V	
		8750 W				10000 W			
		7400 W				8600 W			
		600 V				600 V			
		250 V - 480 V / 310 V				300 V - 480 V / 345 V			
		250 V / 300 V				300 V / 365 V			
		30 A				30 A			
		20 A				20 A			
		1				1			
		4				4			
		7000 W / 7000 VA				7680 W / 8000 VA			
208 V / 183 V - 229 V		240 V / 211 V - 264 V		277 V / 244 V - 305 V		240 V / 211 V - 264 V		277 V / 244 V - 305 V	
		60 Hz / 59.3 Hz ... 60.5 Hz				60 Hz / 59.3 Hz ... 60.5 Hz			
34 A		29 A		25 A		32 A		29 A	
		1				1			
1 / 2		1 / 2		1 / 1		1 / 2		1 / 1	
95.5 % / 97.1 %		96 % / 96.9 %		96 % / 97.1 %		96 % / 96.3 %		96 % / 96.5 %	
		●				●			
		●				●			
		●				●			
		○				○			
		I				I			
		III				III			
		470 / 615 / 240 mm (18.4 / 24.1 / 9.5 inch)				470 / 615 / 240 mm (18.4 / 24.1 / 9.5 inch)			
		187 / 297 / 190 mm (7.3 / 11.7 / 7.5 inch)				187 / 297 / 190 mm (7.3 / 11.7 / 7.5 inch)			
		64 kg / 143 lb				66 kg / 145 lb			
		3.5 kg / 8 lb				3.5 kg / 8 lb			
		-25 °C ... +45 °C / -13 °F ... +113 °F				-25 °C ... +45 °C / -13 °F ... +113 °F			
		46 dB(A)				49 dB(A)			
		0.1 W				0.1 W			
		LF transformer				LF transformer			
		OptiCool				OptiCool			
		NEMA 3R				NEMA 3R			
		NEMA 3R				NEMA 3R			
		100 %				100 %			
		Screw terminal				Screw terminal			
		Screw terminal				Screw terminal			
		Text line				Text line			
		○ / ○				○ / ○			
		● / ○ / ○				● / ○ / ○			
		UL1741, UL1998, IEEE1547, FCC Part 15 (Class A & B), CAN/CSA C22.2 107.1-1, C22.2, UL 1699B				UL1741, UL1998, IEEE1547, FCC Part 15 (Class A & B), CAN/CSA C22.2 107.1-1, C22.2, UL 1699B			
		SB 7000US				SB 8000US			



#### UL listed

- For countries that require UL listing (UL 1741/IEEE 1547/CAN CSA C22.2 107)

#### Economical

- 96.8 % peak efficiency
- OptiCool active temperature management

#### Reliable

- Galvanic isolation
- Arc-fault circuit interrupter (AFCI), optional

#### Simple

- Automatic grid voltage detection<sup>1</sup>
- Integrated DC switch-disconnector



## SUNNY BOY 3000-US / 3800-US / 4000-US

UL listed, reliable system managers

Specially designed for countries that require UL listing, these Sunny Boy inverters guarantee a safe installation process thanks to the automatic grid voltage detection<sup>1</sup>. The integrated DC circuit breaker simplifies the installation process and saves installation costs. Since the devices are suitable for PV array grounding, they can be combined with all module types. In addition, OptiCool guarantees the highest yields possible and a long electrical endurance, even under extreme conditions. The Sunny Boy 3800-US is designed for projects with a current limit of 16 A.

<sup>1</sup> US patent US7352549B1



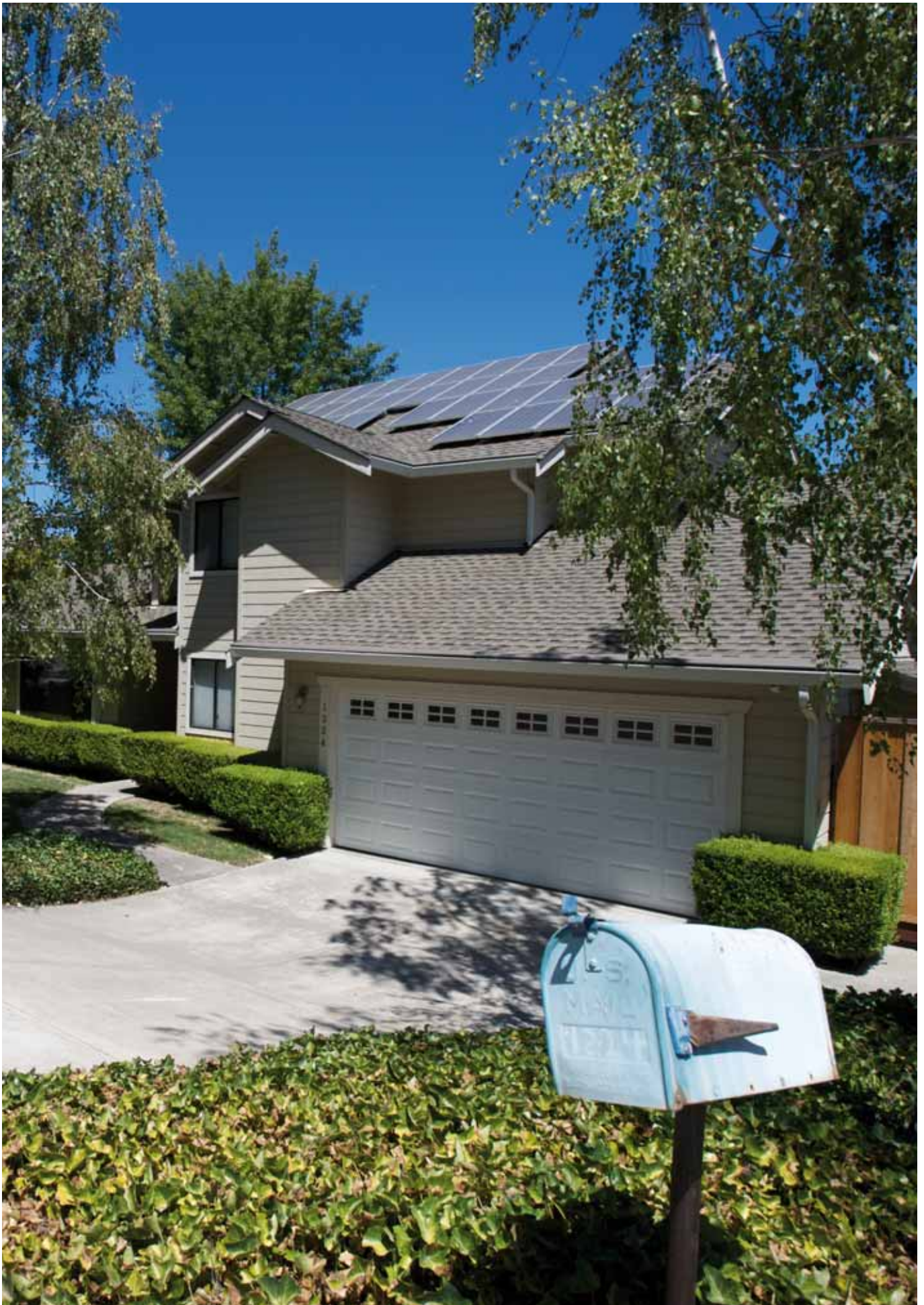

Walnut Creek, USA

# SUNNY BOY 3000-US / 3800-US / 4000-US

Technical data	Sunny Boy 3000-US 208 V	Sunny Boy 3000-US 240 V	
<b>Input (DC)</b>			
Max. recommended PV power (@ module STC)	3750 W		
Max. DC power (@ $\cos \varphi = 1$ )	3200 W		
Max. input voltage	500 V		
MPP voltage range / rated input voltage	200 V - 400 V / 250 V		
Min. input voltage / initial input voltage	175 V / 228 V		
Max. input current	17 A		
Max. string fuse on the DC disconnect	20 A		
Number of independent MPP inputs	1		
Strings per MPP input (@ DC disconnect)	4		
<b>Output (AC)</b>			
Rated power / max. apparent AC power	3000 W / 3000 VA		
Nominal AC voltage / nominal AC voltage range	208 V / 183 V - 229 V	240 V / 211 V - 264 V	
AC power frequency / range	60 Hz / 59.3 Hz ... 60.5 Hz		
Max. output current	15 A	13 A	
Power factor at rated power	1		
Feed-in phases / connection phases	1 / 2	1 / 2	
<b>Efficiency</b>			
CEC efficiency / max. efficiency	95 % / 96 %	95.5 % / 96.5 %	
<b>Protective devices</b>			
DC reverse polarity protection	●		
AC short-circuit current capability	●		
Galvanically isolated	●		
Arc-fault circuit interrupter (according to UL 1699B) <sup>1</sup>	○		
Protection class (according to IEC 62103)	I		
Overvoltage category (according to IEC 60664-1)	III		
<b>General data</b>			
Dimensions (W / H / D)	450 / 350 / 235 mm (17.8 / 13.8 / 9.3 inch)		
Dimensions of DC Disconnect (W / H / D)	187 / 297 / 190 mm (7.3 / 11.7 / 7.5 inch)		
Weight	38 kg / 84 lb		
Weight of DC Disconnect	3.5 kg / 8 lb		
Operating temperature range <sup>1</sup>	-25 °C ... +45 °C / -13 °F ... +113 °F		
Noise emission (typical)	40 dB(A)		
Self-consumption (night)	0.1 W		
Topology	LF transformer		
Cooling concept	OptiCool		
Degree of protection	NEMA 3R		
Degree of protection of connection area	NEMA 3R		
Max. permissible value for relative humidity (non-condensing)	100 %		
<b>Features</b>			
DC connection	Screw terminal		
AC connection	Screw terminal		
Display	Text line		
Interface: RS485 / Bluetooth	○ / ○		
Warranty: 10 / 15 / 20 years	● / ○ / ○		
Certificates and approvals (more available on request)	UL1741, UL1998, IEEE1547, FCC Part 15 (Class A & B), CAN/CSA C22.2 107.1-1, C22.2, UL 1699B		
Type designation	SB 3000US		

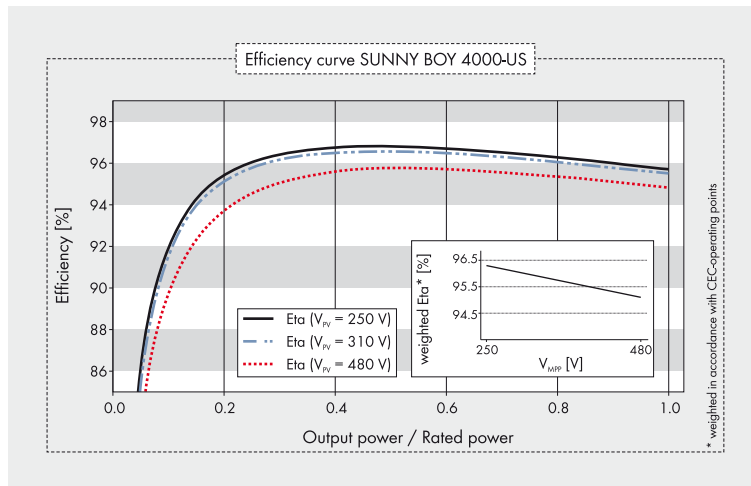

## Accessories

 RS485 interface  
485USPB-NR

 Bluetooth  
Piggy-Back BTPBINV-NR

<sup>1</sup> SB 3000US-12 / SB 3800US-12 / SB 4000US-12 also available with arc-fault circuit interrupter and operating temperature from -40 °C to +45 °C / -40 °F to +113 °F

● Standard feature ○ Optional feature – Not available  
Data at nominal conditions

Technical data	Sunny Boy 3800-US 240 V	Sunny Boy 4000-US 208 V	Sunny Boy 4000-US 240 V
<b>Input (DC)</b>			
Max. recommended PV power (@ module STC)	4750 W		4375 W
Max. DC power (@ cos φ = 1)	4200 W		4200 W
Max. input voltage	600 V		600 V
MPP voltage range / rated input voltage	250 V – 480 V / 310 V		220 V – 480 V / 310 V
Min. input voltage / initial input voltage	250 V / 285 V		220 V / 285 V
Max. input current	18 A		18 A
Max. string fuse on the DC disconnect	18 A		18 A
Number of independent MPP inputs	1		1
Strings per MPP input (@ DC disconnect)	4		4
<b>Output (AC)</b>			
Rated power / max. apparent AC power	3800 W / 3800 VA		3500 W / 3500 VA
Nominal AC voltage / nominal AC voltage range	240 V / 211 V – 264 V	208 V / 183 V – 229 V	240 V / 211 V – 264 V
AC power frequency / range	60 Hz / 59.3 Hz ... 60.5 Hz		60 Hz / 59.3 Hz ... 60.5 Hz
Max. output current	16 A	17 A	17 A
Power factor at rated power	1		1
Feed-in phases / connection phases	1 / 2	1 / 2	1 / 2
<b>Efficiency</b>			
CEC efficiency / max. efficiency	96 % / 96.8 %	95.5 % / 96.5 %	96 % / 96.8 %
<b>Protective devices</b>			
DC reverse polarity protection		●	
AC short-circuit current capability		●	
Galvanically isolated		●	
Arc-fault circuit interrupter (according to UL 1699B) <sup>1</sup>		○	
Protection class (according to IEC 62103)		I	
Overvoltage category (according to IEC 60664-1)		III	
<b>General data</b>			
Dimensions (W / H / D)		450 / 350 / 235 mm (17.8 / 13.8 / 9.3 inch)	
Dimensions of DC Disconnect (W / H / D)		187 / 297 / 190 mm (7.3 / 11.7 / 7.5 inch)	
Weight		38 kg / 84 lb	
Weight of DC Disconnect		3.5 kg / 8 lb	
Operating temperature range <sup>1</sup>		-25 °C ... +45 °C / -13 °F ... +113 °F	
Noise emission (typical)		37 dB(A)	
Self-consumption (night)		0.1 W	
Topology		LF transformer	
Cooling concept		OptiCool	
Degree of protection		NEMA 3R	
Degree of protection of connection area		NEMA 3R	
Max. permissible value for relative humidity (non-condensing)		100 %	
<b>Features</b>			
DC connection		Screw terminal	
AC connection		Screw terminal	
Display		Text line	
Interface: RS485 / Bluetooth		○ / ○	
Warranty: 10 / 15 / 20 years		● / ○ / ○	
Certificates and approvals (more available on request)		UL1741, UL1998, IEEE1547, FCC Part 15 (Class A & B), CAN/CSA C22.2 107.1-1, C22.2, UL 1699B	
Type designation	SB 3800-US		SB 4000US





#### High yields

- Maximum efficiency 96 %
- The best MPP tracking efficiency with OptiTrac MPP tracking
- OptiCool active temperature management

#### Reliable

- Galvanic isolation
- Integrated DC switch-disconnector

#### User-friendly

- Perfect-fit integration in walls of wooden-frame houses
- Plug-in grounding with GFDI
- Reduced weight
- Quick and easy configuration thanks to Quick Module

#### Informative

- Graphic display
- *Bluetooth* as standard



## SUNNY BOY 2000HF-US / 2500HF-US / 3000HF-US

Pretty good yields

This is the new generation of inverters designed for the countries with UL listing – packed full of the latest SMA technology, these devices provide the highest yields for transformer inverters of this power class. The slim enclosure allows for perfect fitting of the Sunny Boy in walls of wooden-frame houses. At the same time, installation is made even simpler due to automatic grid type detection<sup>1</sup>, plug-in PV array grounding with GFDI and reduced weight. The wide input voltage range from 175 to 600 V gives you extraordinary flexibility for your plant design. And the modern graphic display and the wireless *Bluetooth* communication system make the device highly user friendly.

<sup>1</sup> US patent US7352549B1

Technical data	Sunny Boy 2000HF-US 208 V	Sunny Boy 2000HF-US 240 V
<b>Input (DC)</b>		
Max. recommended PV power (@ module STC)	2500 W	
Max. DC power (@ $\cos \varphi = 1$ )	2100 W	
Max. input voltage	600 V	
MPP voltage range / rated input voltage	175 V - 480 V / 415 V	
Min. input voltage / initial input voltage	175 V / 220 V	
Max. input current	15 A	
Max. input current per string	15 A	
Number of independent MPP inputs / strings per MPP input	1 / 2	
<b>Output (AC)</b>		
Rated power / max. apparent AC power	2000 W / 2000 VA	
Nominal AC voltage / nominal AC voltage range	208 V / 183 V - 229 V	240 V / 211 V - 264 V
AC power frequency / range	60 Hz / 59.3 Hz ... 60.5 Hz	
Max. output current	10 A	8.5 A
Power factor at rated power	1	
Feed-in phases / connection phases	1 / 2	1 / 2
<b>Efficiency</b>		
CEC efficiency / max. efficiency	96.5 % / 97.1 %	96.5 % / 97.1 %
<b>Protective devices</b>		
DC reverse polarity protection	●	
AC short-circuit current capability	●	
Galvanically isolated	●	
Arc-fault circuit interrupter (according to UL 1699B)	-	
Protection class (according to IEC 62103) / overvoltage category (according to IEC 60664-1)	NEMA 3R / III	
<b>General data</b>		
Dimensions (W / H / D)	348 / 727 / 183 mm (14 / 29 / 7 inch)	
Weight	23 kg / 51 lb	
Operating temperature range	-25 °C ... +45 °C / -13 °F ... +113 °F	
Noise emission (typical)	38 dB(A)	
Self-consumption (night)	1 W	
Topology	HF transformer	
Cooling concept	OptiCool	
Degree of protection	NEMA 3R	
Degree of protection of connection area	NEMA 3R	
Max. permissible value for relative humidity (non-condensing)	100 %	
<b>Features</b>		
DC connection	Spring clamp terminal	
AC connection	Spring clamp terminal	
Display	Graphic	
Interface: RS485 / Bluetooth	○ / ●	
Warranty: 10 / 15 / 20 years	● / ○ / ○	
Certificates and approvals (more available on request)	UL1741, UL1998, IEEE1547, FCC Part 15 (Class A & B), CAN/CSA C22.2 107.1-1, C22.2, UL 1699B	
Type designation	SB 2000HFUS-30	



# SUNNY BOY 2000HF-US / 2500HF-US / 3000HF-US

Technical data	Sunny Boy 2500HF-US 208 V	Sunny Boy 2500HF-US 240 V
<b>Input (DC)</b>		
Max. recommended PV power (@ module STC)	3125 W	
Max. DC power (@ $\cos \varphi = 1$ )	2600 W	
Max. input voltage	600 V	
MPP voltage range / rated input voltage	220 V - 480 V / 415 V	
Min. input voltage / initial input voltage	175 V / 220 V	
Max. input current	15 A	
Max. input current per string	15 A	
Number of independent MPP inputs / strings per MPP input	1 / 2	
<b>Output (AC)</b>		
Rated power / max. apparent AC power	2500 W / 2500 VA	
Nominal AC voltage / nominal AC voltage range	208 V / 183 V - 229 V	240 V / 211 V - 264 V
AC power frequency / range	60 Hz / 59.3 Hz ... 60.5 Hz	
Max. output current	12 A	10.4 A
Power factor at rated power	1	1
Feed-in phases / connection phases	1 / 2	1 / 2
<b>Efficiency</b>		
CEC efficiency / max. efficiency	96.5 % / 97.1 %	96.5 % / 97.1 %
<b>Protective devices</b>		
DC reverse polarity protection	●	
AC short-circuit current capability	●	
Galvanically isolated	●	
Arc-fault circuit interrupter (according to UL 1699B)	-	
Protection class (according to IEC 62103) / overvoltage category (according to IEC 60664-1)	NEMA 3R / III	
<b>General data</b>		
Dimensions (W / H / D)	348 / 727 / 183 mm (14 / 29 / 7 inch)	
Weight	23 kg / 51 lb	
Operating temperature range	-25 °C ... +45 °C / -13 °F ... +113 °F	
Noise emission (typical)	38 dB(A)	
Self-consumption (night)	1 W	
Topology	HF transformer	
Cooling concept	OptiCool	
Degree of protection	NEMA 3R	
Degree of protection of connection area	NEMA 3R	
Max. permissible value for relative humidity (non-condensing)	100 %	
<b>Features</b>		
DC connection	Spring clamp terminal	
AC connection	Spring clamp terminal	
Display	Graphic	
Interface: RS485 / Bluetooth	○ / ●	
Warranty: 10 / 15 / 20 years	● / ○ / ○	
Certificates and approvals (more available on request)	UL1741, UL1998, IEEE1547, FCC Part 15 (Class A & B), CAN/CSA C22.2 107.1-1, C22.2, UL 1699B	
Type designation	SB 2500HFUS-30	

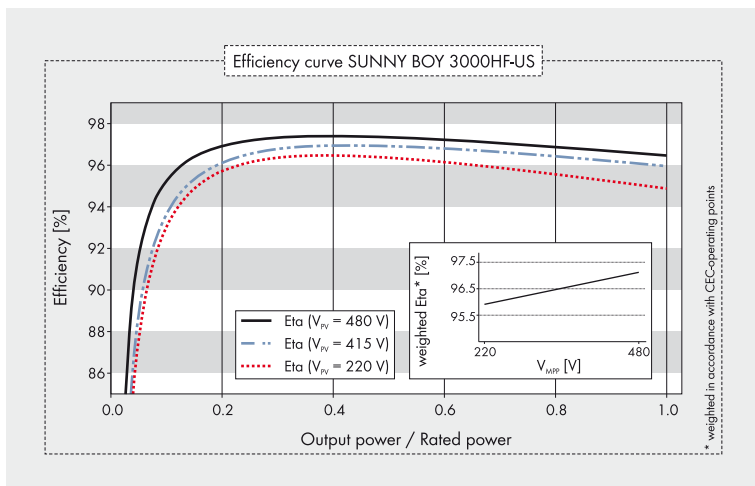

Accessories



Wooden frame construction installation box Flush-Mount Kit Mount-KIT-10-NR



Quick Module RS485 + multi-function relay 485QMUS-10-NR



String fuse retrofit kit, SB-SFK-US-10-NR

● Standard feature ○ Optional feature – Not available  
Data at nominal conditions

Technical data	Sunny Boy 3000HF-US 208 V	Sunny Boy 3000HF-US 240 V
<b>Input (DC)</b>		
Max. recommended PV power (@ module STC)		3750 W
Max. DC power (@ cos φ = 1)		3150 W
Max. input voltage		600 V
MPP voltage range / rated input voltage		220 V - 480 V / 415 V
Min. input voltage / initial input voltage		220 V / 220 V
Max. input current		15 A
Max. input current per string		15 A
Number of independent MPP inputs / strings per MPP input		1 / 2
<b>Output (AC)</b>		
Rated power / max. apparent AC power		3000 W / 3000 VA
Nominal AC voltage / nominal AC voltage range	208 V / 183 V - 229 V	240 V / 211 V - 264 V
AC power frequency / range		60 Hz / 59.3 Hz ... 60.5 Hz
Max. output current	14.8 A	12.5 A
Power factor at rated power	1	1
Feed-in phases / connection phases	1 / 2	1 / 2
<b>Efficiency</b>		
CEC efficiency / max. efficiency	96.5 % / 97.1 %	96.5 % / 97.1 %
<b>Protective devices</b>		
DC reverse polarity protection	●	●
AC short-circuit current capability	●	●
Galvanically isolated	●	●
Arc-fault circuit interrupter (according to UL 1699B)	–	–
Protection class (according to IEC 62103) / overvoltage category (according to IEC 60664-1)		NEMA 3R / III
<b>General data</b>		
Dimensions (W / H / D)		348 / 727 / 183 mm (14 / 29 / 7 inch)
Weight		23 kg / 51 lb
Operating temperature range		-25 °C ... +45 °C / -13 °F ... +113 °F
Noise emission (typical)		38 dB(A)
Self-consumption (night)		1 W
Topology		HF transformer
Cooling concept		OptiCool
Degree of protection		NEMA 3R
Degree of protection of connection area		NEMA 3R
Max. permissible value for relative humidity (non-condensing)		100 %
<b>Features</b>		
DC connection		Spring clamp terminal
AC connection		Spring clamp terminal
Display		Graphic
Interface: RS485 / Bluetooth		○ / ●
Warranty: 10 / 15 / 20 years		● / ○ / ○
Certificates and approvals (more available on request)		UL1741, UL1998, IEEE1547, FCC Part 15 (Class A & B), CAN/CSA C22.2 107.1-1, C22.2, UL 1699B
Type designation		SB 3000HFUS-30



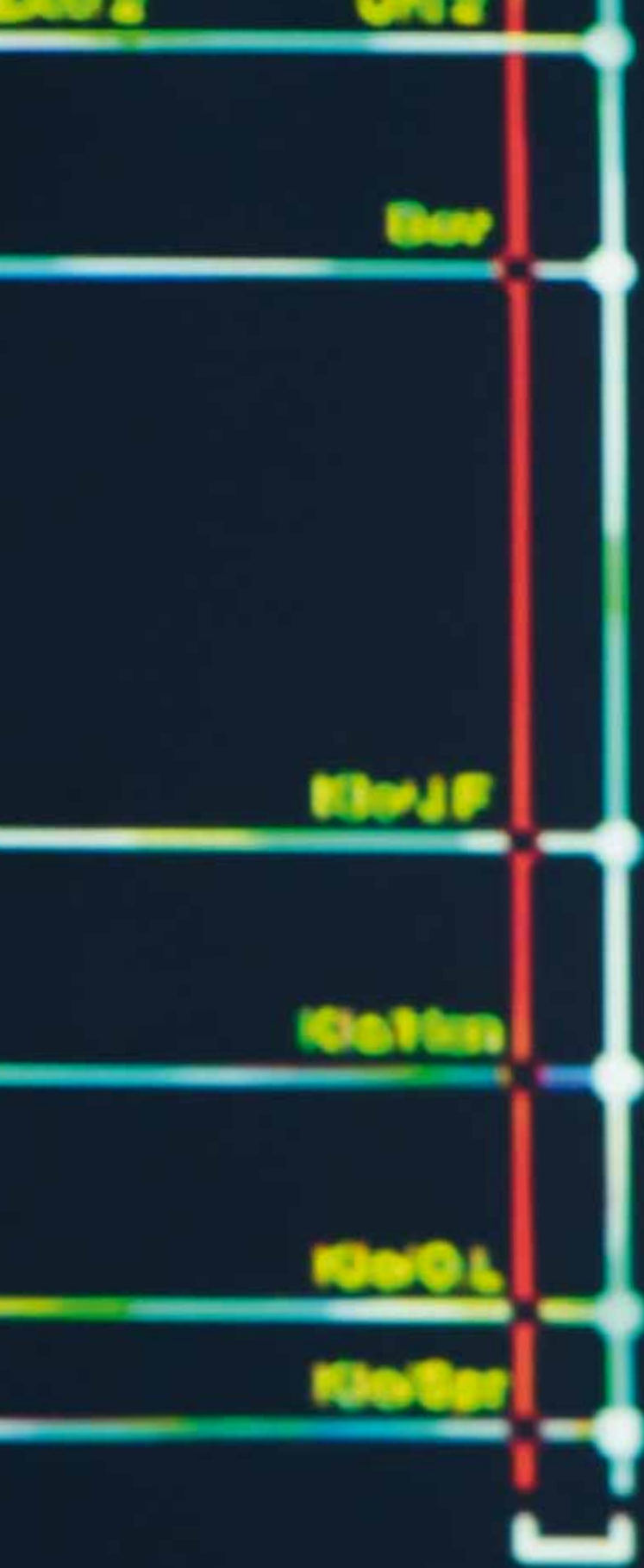

# SYSTEM TECHNOLOGY



# PV inverters

## Basic facts for design and planning

The inverter is the heart of every PV plant: it converts direct current of the PV modules into grid-compliant alternating current and feeds the current into the public grid. At the same time, it controls and monitors the entire plant. SMA offers a variety of PV inverters, which can be divided according to three important characteristics: power, the DC-side design, and the circuit topology.

### **Power**

The available inverter power starts at 1 600 watts and extends into the megawatt range. Typical nominal power ranges from 3 to 6 kW (one kilowatt is equal to 1000 watts) for private residential systems, 10 to 20 kW for commercial PV plants on the roof of a hall or barn, for example, and 500 to 800 kW for PV power stations.

### **Module wiring**

The DC-related design concerns the wiring of the PV modules to the inverter. A distinction is made here between module, string, multistring and central inverters, where the term "string" refers to a strand of modules connected in series.

Multistring inverters have two or more string inputs, each with its own MPP tracker (Maximum Power Point) (see below). They are particularly interesting if you have a PV array with a variety of partial surfaces that face different directions or are partially shaded. Central inverters only have one MPP tracker despite their higher power output. They are especially well-suited for large-scale PV plants with a homogeneous PV array.



### Circuit topology

Regarding circuit topology, distinctions are made between single and three-phase inverters, and between devices with and without transformers. The majority of smaller PV plants use single-phase inverters. However, if a plant exceeds a certain energy-output level a system with several single-phase inverters or a three-phase inverter needs to be used so the load to the three-phase power distribution grid maintains balanced.

The transformer serves the purpose of a galvanic isolation between the PV plant and the power distribution grid (required in some countries) and allows to ground the PV module (necessary for some types of modules). Transformerless inverters are used where possible, because they are generally smaller and lighter than transformers and generally feature a higher efficiency level.

### What does a PV inverter do?

#### 1. Low-loss conversion

One of the most important characteristics of an inverter is its efficiency. It indicates what proportion of the energy “put in” as direct current comes back out in the form of alternating current. The best SMA device features an efficiency in excess of 99 percent.

#### 2. Power optimization

One critical task of the inverter is to make sure that the PV modules are always working at their optimum power levels. Depending on temperature and irradiation intensity, there is always a precise combination of electrical current strength and voltage that allows a PV module to achieve its maximum power, which is also called its maximum power point, or MPP. Since temperature and irradiation intensity are constantly changing (very quickly when clouds pass over), the inverter must continuously monitor the MPP to ensure that the PV modules are supplying as much power as possible. The inverter relies on a software program called “MPP Tracker” for this purpose. Multistring inverters have multiple MPP trackers so that differently aligned substrings can be operated independently.

#### 3. Monitoring and securing

Apart from the PV array, the inverter also monitors the power distribution grid it is connected to. If the specified limiting values for voltage and frequencies are not maintained, it will disconnect the PV plant from the grid or contribute to the grid support to ensure safety, depending on the local grid operator’s specific needs. However, if there is a slight increase in the frequency, the inverter will reduce its power accordingly to ensure that grid specifications are met.

In addition, in most cases nearly every SMA inverter has a device that can safely interrupt the current from the PV modules. PV modules are always live when light is shining on them and cannot be switched off. If the inverter cable is disconnected during operation, this can lead to dangerous electric arcs forming, which do not go out on account of the direct current. A cutout device integrated directly in the inverter considerably reduces installation and wiring efforts compared to an external solution.

#### 4. Communication

The inverter collects data on the energy yields of the PV plant, monitors the electrical activity of the PV array and signals when problems occur. The yield data can be viewed on the device itself or analyzed if suitable communication technology or software is available. It is also possible to have data automatically sent to Sunny Portal, the world’s largest online portal for analysis, visualization and presentation of plant data.

#### 5. Reliable operation

PV plants are designed to operate for a period of at least twenty years that means their internal components have to be particularly robust and long-lasting. One of the great advantages of photovoltaics is that there are no moving parts, and systems are therefore almost unaffected by wear and tear.

However, an inverter is a high-tech device with sensitive electronics inside, which must function reliably in any weather and when exposed to the elements. A weatherproof enclosure, ideally built in line with protective rating IP65, allows the inverter to be installed in any desired place outdoors and is virtually the standard for SMA inverters.

Therefore, an efficient and reliable cooling system for the enclosure is very important in this context, such as SMA’s OptiCool cooling concept. The optimum thermal layout of the components allows them to dissipate their heat directly to the environment, while the whole enclosure acts as a heat sink at the same time. This allows the inverters to work at maximum nominal power even at ambient temperatures of up to 50 °C, which increases the energy yield even more.



### Simple

- Optimal design for grid-connected PV plants
- Tips aimed at plant optimization
- Free download

### Comprehensive

- Database of current PV modules
- Use of high-resolution meteorological data
- Automatic online updates
- Generation of design proposals
- Energetic evaluation of an operational year
- Forecast of projected self-consumption

### Flexible

- Worldwide location support
- Import of your own load profiles and meteorological data
- Custom calculation of the optimum dimensioning for inverters



## SUNNY DESIGN

Plant design made easy

With Sunny Design, designing PV plants is easier than ever. Simply enter all the required information and within a few minutes you will receive the optimum plant configuration. The free software provides solar power professionals and plant planners with a user-friendly interface. Along with the technical inspection of different components, the software also provides data for economic evaluation of the plant. The end customer gains a customized PV plant and the solar power professional saves valuable time.

Sunny Design contains important SMA inverter data as well as specifications on all available PV modules. It is easy to use and guides the planner through the entire design process. This saves time and allows different configuration options to be simulated without the need for complicated calculations.

Potentially critical operating states are detected and identified. This ensures that the planner is notified of any deviations from the standard design. Although this notification does not necessarily mean that the design is not permissible, it indicates whether a thorough check is required.

The software also helps to estimate the yield and investment costs of the most important parameters, thus offering a customized plant.

Additionally, realistic operation is evaluated over a calendar year on the basis of the integrated meteorological database. Although a precise yield forecast is not to be expected from Sunny Design (further simulation programs are necessary for this), it can determine the yield differences between various designs, including a technical performance verification.

Finally, a technical assessment of the plant design is clearly illustrated in an individually customized results report. As a printed document or an electronic PDF file, this summary is the ideal supplement to any offer.

In addition to a redesigned user interface, the new Sunny Design version also offers enhanced options. For example, you can see design proposals that help you to quickly and easily select the optimal configuration. Even complex PV plants with several different sub-strings and inverter types can now be combined in a single project. Besides, you can get current online updates for Sunny Design.

#### Free download at

[www.SMA.de/SunnyDesign](http://www.SMA.de/SunnyDesign)

#### Note:

You can find background information for the determination of the optimum inverter dimensioning with Sunny Design in Chapter "Know-how".

## System Requirements

### Supported operating systems

Windows XP SP3\*

Windows Vista SP2\*

Windows 7\*

\*With .Net Framework 4.0

### Hardware (minimum requirements)

Intel Pentium 1 GHz

1 GB RAM

100 MB (free hard drive space)

1024 x 768 pixels / 256 colors



Use of real, high-resolution meteorological data



Database of current PV modules



Database of all SMA inverters



Provides tips aimed at plant optimization



Worldwide support



Generation of design proposals

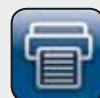

Results report with individual layout for integration into plant quotes



Automatic online updates



### Simple

- Automatic position determination
- Determination of roof pitch and orientation
- Online meteorological data for determining the irradiation values

### Quickly

- Online feed-in compensation and average original costs
- Determination of yield and expected profits
- Integrated financing calculator

### User-friendly

- SMA solar power professional search\*
- Telephone or e-mail inquiries at the press of button
- Free download in Apple App Store



## SMA SOLARCHECKER

iPhone app for estimating PV plant yield

"Is it worth having a PV plant on my roof?" This is a question many homeowners ask themselves. Solar power professionals with an iPhone (3GS or newer) can answer this question in just a few seconds, thanks to the Solarchecker from SMA. This iPhone app quickly and conveniently estimates the yield of a PV plant, right before your eyes.

Traditionally, solar power professionals would need a long time before they could provide potential customers with an initial yield estimate. Now, solar power professionals can instantly calculate this estimate using an iPhone and the SMA Solarchecker. This mobile device features integrated sensors allowing to automatically determine the location, orientation and pitch of the roof. The SMA Solarchecker app uses the data, along with custom information such as plant size and financing costs, to estimate the power output and yield. Although the estimate does not replace the final, detailed design of the plant, it saves valuable time and quickly convinces customers of the benefits of these cost-effective and environmentally-friendly plants.

### The iPhone as a solar power planner

The SMA Solarchecker finds the operator's current location using the iPhone's GPS tracker. Using these values, the app determines the site's potential solar irradiation, which is derived from a GPS-based weather database. Using the iPhone's magnetic compass, the app then measures to what degree the roof deviates from the ideal south-facing orientation. The device also determines the possible inclination of the PV array using the tilt sensor. The SMA Solarchecker then uses these values to determine the specific yield of a PV plant, i.e. the number of kilowatt hours produced per kW of power.

### Calculating the energy yield with the Solarchecker

To determine the energy yield, the planned power of the PV array must be calculated first. The SMA Solarchecker offers two ways to complete this step. The user can enter the power directly in kWp or enter the number of square meters of the designed PV plant. In the latter case, the app automatically converts the roof area size into the amount of power. Of course, the application takes into account the previously specified PV module type.

The SMA Solarchecker calculates the amount of annual energy yield of the PV plant by multiplying the specific yield value from the roof area with the planned peak power. Long-term estimates, e.g. over 20 years, are also possible.

### Yield estimate at the press of a button

For locations with a feed-in compensation, simply type in the current feed-in compensation rate per kilowatt hour and the expected financing costs and the app will estimate the possible yield that can be generated by the designed PV plant.

### Free download of the SMA Solarchecker

[www.apple.com/itunes](http://www.apple.com/itunes)

### Important information:

Since the returns and profits are dependent on the estimate of the specific annual yield, they both carry a certain degree of uncertainty. SMA therefore assumes no liability for lower actual yield results, which can also be caused by other factors such as shading, dirt or otherwise compromised modules. For more precise yield calculations, SMA recommends consulting a qualified solar power professional or plant planner.



Use of approved irradiation data



Automatic determination of position, pitch and orientation



Manual input of roof area, module type and maintenance costs



Integrated financing calculator



Yield and profit estimate at the press of a button

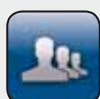

Integrated solar power professional search\*



Data transmission via automatically generated e-mail



Languages: German, English, Italian, Spanish, French

\* All members of the Sunny PRO Club are included in SMA's solar power professional search.



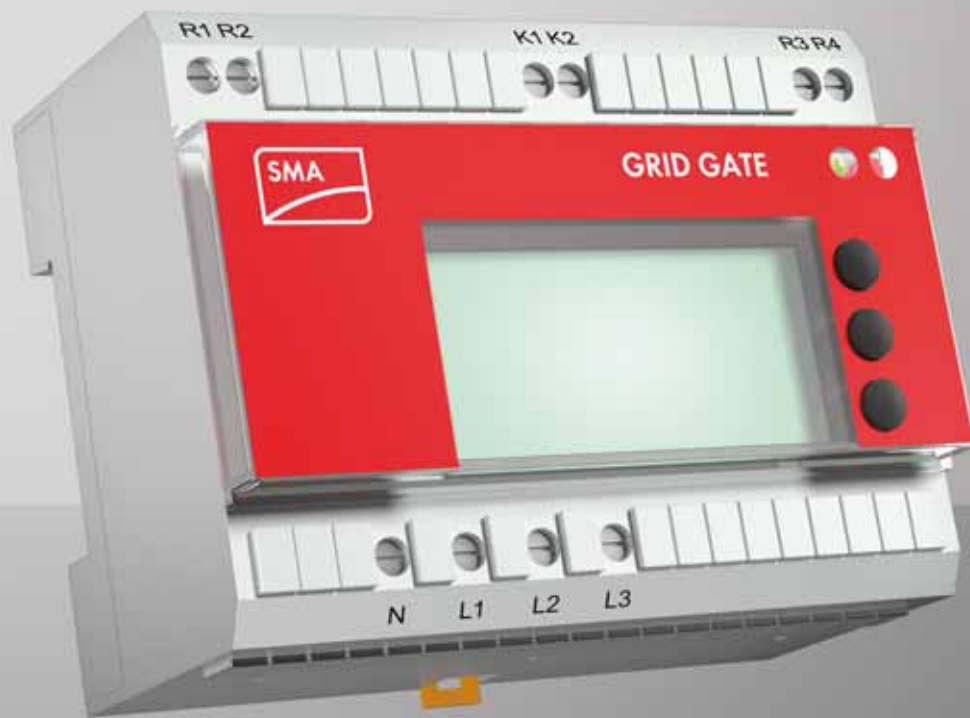

#### Reliable

- Complies with the new application rule VDE-AR-N 4105
- Set up with single-fault tolerance

#### Flexible

- It is binding for all PV plants in Germany with more than 30 kVA
- Universally applicable

#### Simple

- With the default settings, no parameterization is needed
- Easy installation due to top-hat rail mounting

#### Easy to use

- Informative display
- Display of all current power distribution grid and device data



## SMA GRID GATE

Grid and plant protection compliance with rules and standards for plants from 30 kVA

Simple, reliable and typical for SMA – the solution for PV plants in Germany with more than 30 kVA on the low-voltage grid. The SMA Grid Gate is the ideal solution for regulation-compliant plant commissioning according to VDE-AR-N 4105 because it provides the binding grid and plant protection needed as of 2012. It is compatible with all plant sizes and inverter types provided they offer integrated islanding detection, as all SMA inverters do. In addition, it offers the advantage of simple installation using top-hat rail mounting. The user-friendly display permits convenient menu navigation and provides information on the current grid data or device status, for example.

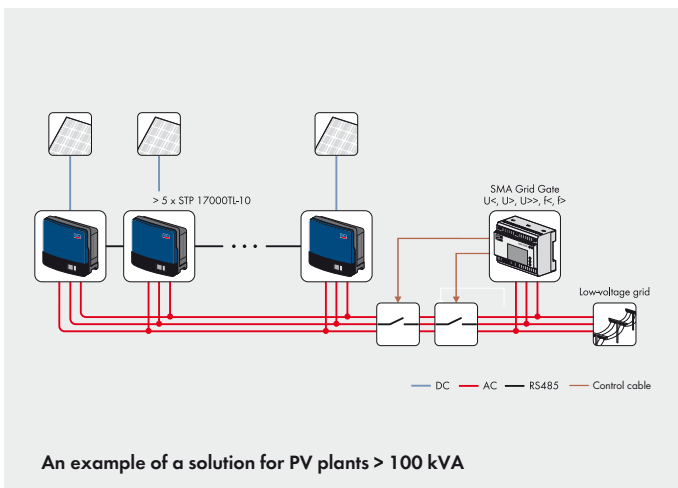
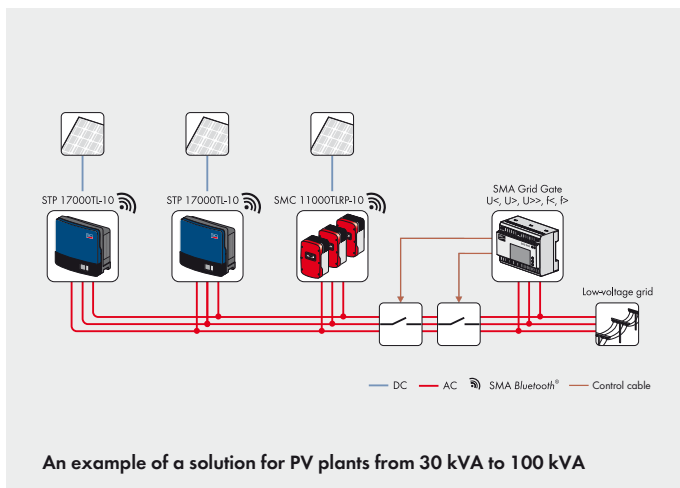

Technical data	
<b>Connection data (AC)</b>	
Nominal AC voltage	230 V
Nominal AC voltage range	80 V – 280 V
AC power frequency	50 Hz
AC power frequency range	45 Hz ... 52 Hz
Control of section switch $I_{AC,max}$	6 A
Control of section switch $U_{AC,max}$	250 V
Connection phases	3
<b>Protective devices</b>	
AC short-circuit current capability	16 A
Protection class (according to IEC 62103)	II
Overvoltage category (according to IEC 664-1)	III
<b>General data</b>	
Dimensions (W / H / D)	100 / 75 / 55 mm
Weight	0.2 kg
Operating temperature range	-20 °C ... +50 °C
Self-consumption	1 W
Degrees of protection (according to IEC 60529)	IP20
Humidity range (relative humidity, non condensing)	10 % ... 90 %
Air pressure range	70 kPa ... 106 kPa
Max. operating altitude	3000 m above NN
Climatic category (according to IEC 60721-3-3)	3K5
Measurement accuracy	1 %
<b>Features</b>	
Connection	Screw terminal
Display	Graphic
Operation	Three-button
Warranty: 5 years	●
Certificates and approvals	CE, VDE-AR-N 4105
● Standard feature ○ Optional feature – Not available	
Type designation	

SMA Grid Gate	
230 V	
80 V – 280 V	
50 Hz	
45 Hz ... 52 Hz	
6 A	
250 V	
3	
16 A	
II	
III	
100 / 75 / 55 mm	
0.2 kg	
-20 °C ... +50 °C	
1 W	
IP20	
10 % ... 90 %	
70 kPa ... 106 kPa	
3000 m above NN	
3K5	
1 %	
Screw terminal	
Graphic	
Three-button	
●	
CE, VDE-AR-N 4105	
GRIDGATE-10	

# BACKUP SYSTEMS







# Sunny Backup system: independence from the power distribution grid with solar power

Use solar power after sunset? Grid failure and still have a reliable electricity supply? It's no problem with a Sunny Backup system because it intelligently stores solar energy. PV plant operators can become even more independent from utility companies with this solution from SMA.

## Increasing self-consumption

Acting as an interface between PV plant and power distribution grid, the Sunny Backup system optimizes the flow of energy in both directions: if the PV plant generates more electricity than the loads require, it is used to charge the battery and not fed into the power distribution grid. The solar current stored is tapped when the loads require it – even after sunset. The Sunny Backup system enables you to substantially increase your self-consumption.

## Flexibility in the battery technology

In order to grant the plant operators the greatest freedom possible in the choice of battery, SMA works in close cooperation

with leading battery manufacturers. The Sunny Backup systems are now even compatible with lithium-ion batteries. The charging cycle is particularly stable for this battery type and it features low storage loss, which is another positive effect in terms of self-consumption.

## The optimum electricity insurance

Today, it is very difficult to do anything without electricity: no light, no heating, no computer, no phone, or cooling systems. And a power outage can have particularly grave economic consequences for businesses. For example, if the stall ventilation system or heat lamps lose power in a farming business. Or the cold chains stop working in hotels, supermarkets and restaurants. For safety reasons, PV plants need to be disconnected from the power distribution grid in the event of a power outage. The Sunny Backup system eliminates this supply gap. As an add-on to the PV plant, it automatically switches to off-grid power supply in the event of a power outage. Acting as an intelligent system manager, Sunny Backup then monitors the energy flow in the

stand-alone grid. The Sunny Backup ensures a reliable solar power supply and is environmentally-friendly.

The Sunny Backup System is the result of more than 30 years' experience in system technology – both for grid-connected PV plants and for stand-alone grids. As a synthesis between grid-connected operation and off-grid technology, the Sunny Backup system guarantees optimum user safety as well as an easy installation.

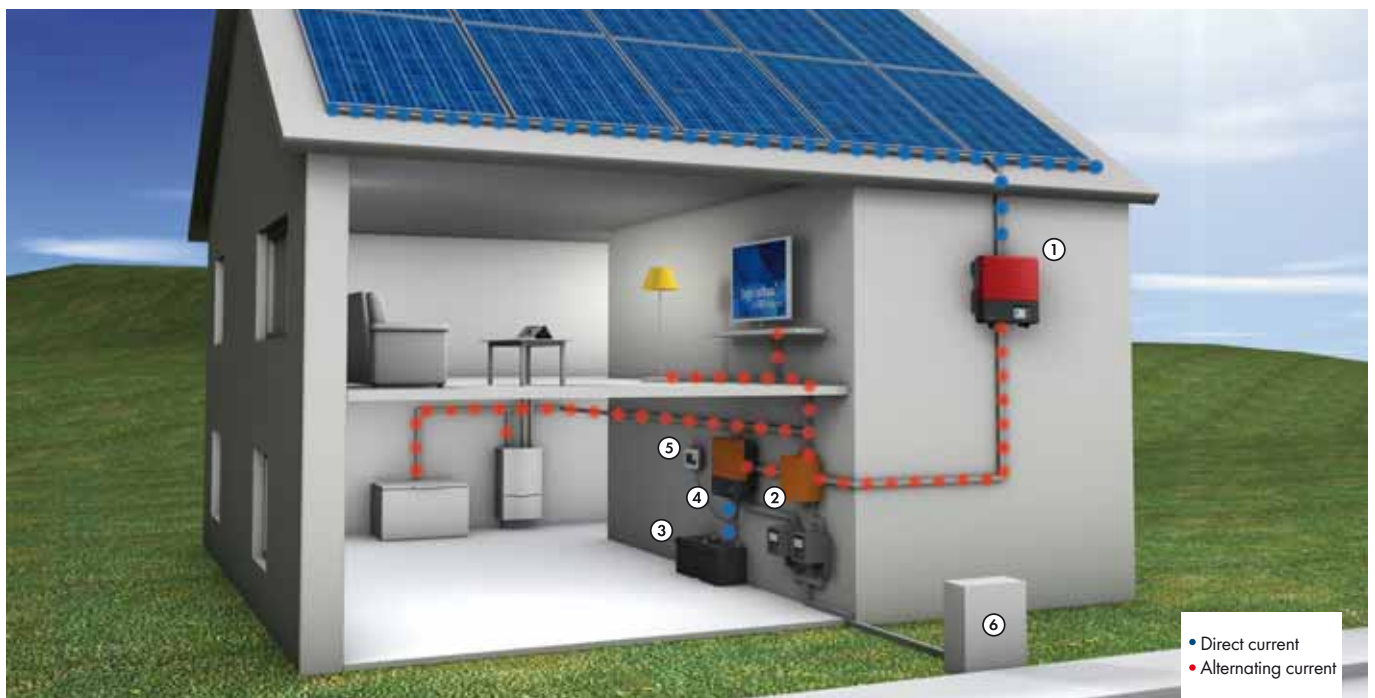

**Components:** 1. Sunny Boy PV inverter, 2. Sunny Backup automatic transfer switch, 3. Sunny Backup battery set, 4. Sunny Backup 2200, 5. Sunny Remote Control, 6. Grid connection



- System M / L for all grounding systems.
- System M with optional phase coupling

#### Simple

- Can be integrated into existing and new PV plants
- On-site configuration of grounding system

#### Flexible

- Capacities from 5 kW to 100 kW available

#### Efficient

- Small battery due to integration of the PV plant
- Constantly high PV efficiency

#### Reliable

- Certified protection concept for TN and TT power distribution grids
- Automatic switching to backup supply in approx. just 20 milliseconds



## SUNNY BACKUP SYSTEM M / L / XL

Solar power, even in the event of grid failure

Greatest performance and user benefits along with the lowest investment and operating costs: Compared to conventional emergency power systems, the Sunny Backup system scores well. As an add-on to the PV plant, the Sunny Backup automatically switches to off-grid power supply within approximately 20 milliseconds of a power outage. Both new and existing PV plants can be equipped with a Sunny Backup system – with no effect on PV efficiency. And the best part: due to the integration of the PV plant, a small and therefore low-cost battery can be implemented as it is usually only needed to bridge the night hours.



Source: juwi solar GmbH, Germany



# SUNNY BACKUP SYSTEM M / L / XL

Technical data	Sunny Backup system M	Sunny Backup system L
<b>Output: loads</b>		
Nominal power / electric current during grid operation	7.4 kW / 32 A at 35 °C	35 kW / 3 x 50 A at 35 °C
Max. power / electric current during grid operation for 30 min	8.9 kW / 38 A at 35 °C	41 kW / 3 x 60 A at 35 °C
Maximum fuse link	40 A	63 A
Backup power (duration / 30 min / 1 min)	5 kW / 6.5 kW / 8.4 kW	15 kW / 19.5 kW / 25.2 kW
Number of phases (grid operation / backup operation)	3/3 x 1 ~	3 / 3
Voltage (range)	230 V (187 V – 253 V)	230 V (187 V – 253 V)
Frequency (range)	50 Hz (45 Hz ... 55 Hz)	50 Hz (45 Hz ... 55 Hz)
Permitted grounding system	TN / TT	TN / TT
Typical interruption time during grid failure	20 ms	20 ms
<b>Input PV plant</b>		
Nominal AC PV power / current	5.7 kW / 25 A at 35 °C	28 kW / 3 x 40 A at 35 °C
Maximum fuse link	32 A	50 A
Compatible PV inverters	www.SMA-Solar.com	www.SMA-Solar.com
<b>Input battery</b>		
Nominal voltage	48 V	48 V
Battery type	Li-Ion / VRLA / FLA / NiCd	Li-Ion / VRLA / FLA / NiCd
<b>Efficiency / self-consumption</b>		
Max. efficiency in backup operation	95 %	95 %
Self-consumption consumption day / night (silent mode)	48 W / 32 W	103 W / 69 W
<b>Protective devices</b>		
DC reverse polarity protection / deep-discharge protection	● / ●	● / ●
AC short circuit / AC overload	● / ●	● / ●
Grid monitoring (SMA Grid Guard) / galvanic isolation	● / ●	● / ●
Protection class (according to IEC 62103)	I	I
Overvoltage category (according to IEC 60664)	III	III
<b>General data</b>		
SBU dimensions (W / H / D)	467 / 612 / 235 mm	467 / 612 / 235 mm
AS-Box dimensions (W / H / D)	550 / 950 / 225 mm	800 / 950 / 225 mm
SBU / AS-Box weight	63 kg / 50 kg	63 kg / 70 kg
Operating temperature range	-25 °C ... +50 °C	-25 °C ... +50 °C
Climatic class (according to IEC 60721-2-1)	4K4H	4K4H
SBU / AS-Box degree of protection (according to IEC 60529)	IP30 / IP54	IP30 / IP54
<b>Features / function</b>		
Integrated bypass in case of fault / test operation	● / ●	● / ●
State of charge calculation	●	●
Data cable	5 m	5 m
Array input (nominal power)	● (32 A at 35 °C)	● (40 A at 35 °C)
SBU / AS-Box warranty (5 / 10 / 15 / 20 / 25 years)	● / ○ / ○ / ○ / ○	● / ○ / ○ / ○ / ○
240 V voltage range (192.5 – 260.0 V)	○	○
Certificates and approvals (further approvals on request)	CE, VDE 0126-1-1	CE, VDE 0126-1-1
<b>Accessories</b>		
Battery cables	○	○
Battery fuse "BATFUSE"	○	○
Interfaces (RS485 PB) / Multicluster PB	○ / ○	○ / ○
● Standard feature ○ Optional feature – Not available		
Type designation	SBU5000 and AS-Box-M-20	3 x SBU5000 and AS-Box-L-20

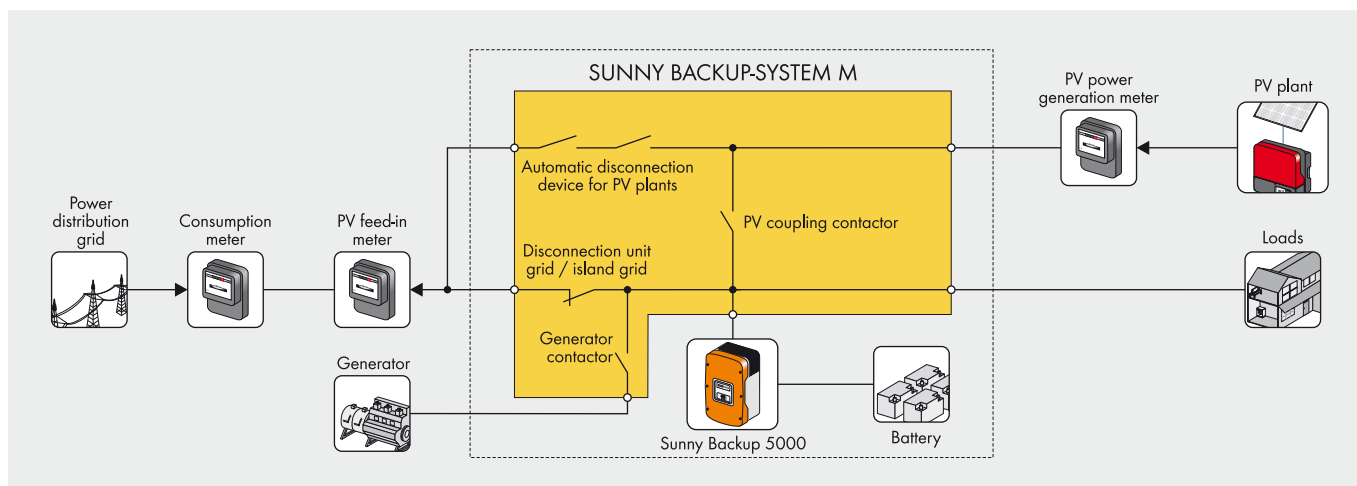

Technical data	Sunny Backup system XL (only for TN)	
<b>Output: loads</b>		
Nominal power / electric current during grid operation	110 kW / 3 x 160 A at 25 °C	
Max. power / electric current during grid operation for 30 min	– / –	
Maximum fuse link	160 A	
Backup power (duration / 30 min / 1 min)	60 kW / 78 kW / 100 kW	
Number of phases (grid operation / backup operation)	3 / 3	
Voltage (range)	230 V (187 V – 253 V)	
Frequency (range)	50 Hz (45 Hz ... 55 Hz)	
Permitted grounding system	TN	
Typical interruption time during grid failure	20 ms	
<b>Input PV plant</b>		
Nominal AC PV power / current	110 kW / 3 x 160 A at 25 °C	
Maximum fuse link	160 A	
Compatible PV inverters	www.SMA-Solar.com	
<b>Input battery</b>		
Nominal voltage	48 V	
Battery type	VRLA / FLA / NiCd	
<b>Efficiency / self-consumption</b>		
Max. efficiency in backup operation	95 %	
Self-consumption consumption day / night (silent mode)	360 W / 230 W	
<b>Protective devices</b>		
DC reverse polarity protection / deep-discharge protection	● / ●	
AC short circuit / AC overload	● / ●	
Grid monitoring (SMA Grid Guard) / galvanic isolation	● / ●	
Protection class (according to IEC 62103)	I	
Overvoltage category (according to IEC 60664)	III	
<b>General data</b>		
SBU dimensions (W / H / D)	467 / 612 / 235 mm	
AS-Box dimensions (W / H / D)	1000 / 1600 / 300 mm	
SBU / AS-Box weight	63 kg / 180 kg	
Operating temperature range	-25 °C ... +50 °C	
Climatic class (according to IEC 60721-2-1)	4K4H	
SBU / AS-Box degree of protection (according to IEC 60529)	IP30 / IP65	
<b>Features / function</b>		
Integrated bypass in case of fault / test operation	● / ●	
State of charge calculation	●	
Data cable	5 m	
Array input (nominal power)	● (160 A at 25 °C)	
SBU / AS-Box warranty (5 / 10 / 15 / 20 / 25 years)	● / ○ / ○ / ○ / ○	
240 V voltage range (192.5 – 260.0 V)	○	
Certificates and approvals (further approvals on request)	CE, VDE 0126-1-1	
<b>Accessories</b>		
Battery cables	○	
Battery fuse "BATFUSE"	○	
Interfaces (RS485 PB) / Multicluster PB	● / ○	
● Standard feature ○ Optional feature – Not available		
Type designation	12 x SBU 5000 and AS-Box-XL	





#### Simple

- Can be integrated into existing and new PV plants
- Pre-configured set

#### Efficient

- Energy supply and battery charging over the power distribution grid
- Unchanged high PV efficiency
- Compact and affordable automatic transfer switch
- Smaller battery size due to integration of the PV plant

#### Reliable

- Automatic switching to backup supply in only approx. 50 milliseconds



## SUNNY BACKUP SET S

Reliable emergency power supply, even for single-family homes

Innovative electricity insurance for private homes: as an add-on to the PV plant, the Sunny Backup set S switches automatically to off-grid mode within 50 milliseconds in the event of grid failure. Whether in summer or winter, if the power goes out, owners of small to medium-sized PV plants and inverters from SMA can supply their most important consumer loads themselves. Our affordable complete solution is suitable for both new PV plants as well as existing PV plants, which can be easily retrofitted with our certified Sunny Backup set S.





**Increase in self-consumption**  
Sunny Backup systems S / M / L

#### High yields

- Increase in self-consumption rate with Sunny Backup

#### Precise

- Fast data recording thanks to D0 interface on electronic meters
- Precise and fast control by means of the Sunny Backup

#### Simple

- Cabling via plug connectors
- Fast top-hat rail mounting



## METER BOX FOR SUNNY BACKUP

Higher self-consumption through buffering of solar power

The Meter Box for Sunny Backup enables current flows to be captured fast and with great precision, thus guaranteeing an optimum increase in self-consumption. After all, the efficient buffering of solar power for night use is the crucial factor for increasing the self-consumption rate. The result: greater independence from the grid operator and a reduction of the volume of electricity purchased from the public electricity grid. To enable Sunny Backup to operate with greatest efficiency, the electricity meters are read out by the Meter Box for Sunny Backup. This precise capture of the current flows enables the battery to be charged and discharged economically, and this in turn maximizes electrical endurance and optimizes self-consumption.





#### **Customer-oriented**

- Professional commissioning, maintenance and repair
- Telephone support through our SMA Service Line

#### **Optimum availability**

- Fast and simple device replacement

#### **Assured returns**

- Five-year manufacturer's warranty
- One-year full warranty on every replacement device

#### **Flexible**

- Extended warranty (10, 15, 20, or 25 years)
- Choice of two extended warranty options

## **SMA Service for decentralized inverter solutions**

Comprehensive service for all customer requirements

All those who opt for a PV plant are banking on long-term yields. Long-lasting PV inverters with peak efficiencies are not all that is required for this. A reliable service partner who is flexible and competent, and who will stand ready with advice and action, is just as important. SMA provides cutting-edge technology and expert service from a single source. Whether the SMA Service Line, SMA on-site service, or SMA replacement devices: our flexible services are individually-tailored to the needs of solar power professionals – worldwide.



### **The SMA replacement device for the optimum in yield stability**

Should a failure occur, we will keep down-times as short as possible by replacing your device. After we have received your call, the replacement inverter is generally shipped the same day. To replace the defective inverter, the customer will receive a comparable device, including all necessary updates. If a device is replaced within the warranty period, the remaining warranty period is transferred to the replacement device. In any event, we provide a one-year full warranty on all replacement devices whether or not the original warranty is still valid. And that's not all: you can have our service technicians take care of the installation of the replacement device.

### **Our SMA Service Line – expert advice over the phone**

Our SMA Service Line supports solar power professionals during the installation and commissioning of PV plants, advises on technical issues, and provides tips on plant monitoring. Our expert teams are available at various telephone numbers for all inquiries regarding inverters and communication products.

### **SMA Service on-site – deployment worldwide**

You can rely on our support: we have a well-developed service infrastructure with numerous access points, currently in 18 countries. In the event of a service requirement, SMA can be on site quickly. Thus, we are ready to support our customers around the world, from on site diagnosis to device replacement.

### **The SMA warranty concept – Flexibility. Guaranteed. Security. Guaranteed.**

SMA stands for high standards and excellent quality. Our inverters come with a five-year manufacturer's warranty.

We offer service custom-tailored to your needs with our SMA warranty concept. Our customers can flexibly choose between two different kinds of extended warranty, and can also decide whether the warranty should be extended for 10, 15, 20, or 25 years.

Visit your local website for more information on the exact conditions available to you.

### **We would be glad to assist you.**

Do you have any questions or wishes, or do you need professional support? If so, you can contact our SMA Service Line at any time. The opening hours and telephone numbers of our expert teams are listed on our website at [www.sma.de/en/service](http://www.sma.de/en/service). There you will find information on our service, too.

# SUNNY PRO | Club

Making Strong Partners Stronger



**NY PRO** Club  
Strong Partners Stronger



**Sunlab**  
10587 Berlin

**Peter Mertens**

Membership Number SPC1236547



### Profitable

- Active sales support with a wide range of professional and affordable marketing measures
- Joint web profile for solar power professional partners of SMA with the market leader
- Acquire new customers by having your solar power professional company listed on the "Solar is Future" customer website and on the SMA website

### Time-saving

- Direct access to the latest product information
- Valuable time and costs savings for solar power professionals



## The Sunny PRO Club

Expert marketing for solar power professionals

PV plants need not only to be planned and installed, but also sold. The SMA partner program for solar power professionals offers its members active marketing support to tap into their regional photovoltaic markets. This not only saves time, but also helps attract new customers.



### Professional marketing support

All promotional measures are specially tailored to meet the individual requirements of the solar trade. Whether with sample devices, personalized brochures or display examples, members receive practical support for all their marketing needs. A particularly attractive advantage is the opportunity to have your company named in the "Solar is Future" end user portal and on your SMA website: club members can use the solar power professional search to increase awareness of their company in their region and acquire new customers.

### The knowledge advantage

The best way of gaining knowledge has always been through personal contact and sharing expertise. If you have any questions or comments, our SMA Service Line staff will be happy to help. Sunny PRO Club members also benefit from exclusive technology and sales seminars at the SMA Solar Academy.

### A partnership that pays off

The principle of give and take: SMA's solar power professionals not only receive professional marketing solutions on attractive terms. As the world's largest manufacturer of PV inverters, SMA is also a strong partner for all Sunny PRO Club members. Just as

solar power professionals can use the marketing power of the SMA brand to improve their image, they in turn also help further increase awareness of the brand.

### Interested?

Becoming a member of the Sunny PRO Club is easy! For a small annual charge, each member receives a start package, a selection of attractive marketing measures, invitations to selected seminars and events, and is also registered in the online solar power professional search function. Simply visit our Sunny PRO Club online. There you will find all you need to register and further details on the services we provide.

#### Sunny PRO Club Germany

Tel. +49 561 9522-4774  
SunnyPROClub@SMA.de  
www.SunnyPROClub.de

#### Sunny PRO Club America

Tel. +1 916 625 0870  
SunnyPROClub@SMA-America.com  
www.SunnyPROinfo.com

#### Sunny PRO Club Italy

Tel. +39 02 8934 7264  
SunnyPROClub@SMA-Italia.com  
www.SunnyPROClub.it

#### Sunny PRO Club France

Tel. +33 (0) 4 72 22 92 90  
SunnyPROClub@SMA-France.com  
www.SunnyPROClub.fr









# SMA BONUS PROGRAM





#### Profitable

- An added bonus for every SMA PV inverter that is installed by redeeming the bonus points for attractive prizes

#### Simple

- Registration is easy: either online or via smartphone

#### Time-saving

- The collected points are immediately tallied up when registering via smartphone



## SMA Bonus Program

Collect points for rewards

One more reason to choose SMA: with the SMA Bonus Program, solar power professionals receive bonus points for every SMA PV inverter\* installed and registered, which they can then exchange for attractive rewards. Solar power professionals who are interested in the program can simply sign up for it. Then they register their devices online or with their smartphone, collect points, and enjoy the benefits. Every installed inverter means an added bonus for smart thinkers.

\* All SMA PV inverters that are eligible for the SMA Bonus Program (after registration) when purchased and installed by a solar power professional. This offer does not include central inverters and replacement devices.

**Point by point to the prize**

How to benefit from the SMA Bonus Program: solar power professionals register the SMA PV inverters they install and then collect valuable points with each device.

They can be registered online or via a mobile device. The fastest way is to register right away on-site with a smartphone and the free Sunny Dots app.

You can find a summary of all devices that qualify for registration on our website at [www.SMA-Bonus.com](http://www.SMA-Bonus.com).



Install inverters

+



Register the unit directly on-site with your smartphone

=



Redeem your bonus points for fabulous prizes





# POWER PLANT SOLUTIONS









# Technology from the Power Plant Class

## It's Our Business

SMA central inverters are used around the world for PV projects in the power plant class. Projects with a capacity of 250 MW and higher can benefit from our more than 30 years' experience as a leader in technology and our expertise with projects in the single-digit and double-digit megawatt range. EPCs, investors, banks and electric utility companies will find a strong partner at their side with SMA, who can thoroughly impress in all project phases.

### Investment in the future

SMA provides the right inverter for any plant accommodating all requirements, power ranges and module types, as well as state-of-the-art system technology for the power plant class. Lower system costs and lower installation and maintenance costs mean large-scale PV plants that attain substantially higher profits. Production sites in Germany, the US and Canada ensure flexibility and quick delivery.

Nearly 1,000 engineers are working on further improvements to the efficiency and competitiveness of all SMA products, every day. Increases in efficiency, lower system costs due to the inverters and more convenient installation and maintenance conditions have a major impact on yields, especially for large-scale PV power stations. That's why SMA invests in research and development and, in turn, in the competitiveness of photovoltaics. Research projects such as the Giga-PV joint project, which promotes the optimization of PV power stations for the Sun Belt, set new standards.

### No. 1 globally

PV power stations with SMA system technology take up leading positions, both in Germany and across the globe. SMA offers top-notch products, comprehensive system solutions and excellent project support ranging from technical advice and plant dimensioning to service and maintenance for all large-scale PV plants, not to mention the technological edge.

### Worldwide service network

SMA inverters are designed to feature an electrical endurance of more than 20 years, because maximum investment security is only ensured when inverters operate reliably over a long period of time. These investments, together with the SMA service offerings, will also pay off in the future. Contracts can be combined individually and flexibly with the modular service concept of Sunny Central. You can turn to the global SMA service network quickly and reliably, anywhere in the world.

### Pioneer in grid integration

SMA is ahead of the game in grid integration, just like it is in technical solutions and service for internationally competitive PV power stations. For years, SMA has been providing customized answers to the requirements placed on power plants worldwide, as well as the technological solutions for implementing them. Because these inverters play an active role in grid stabilization and concepts for PV farm management, they can help steadily increase the amount of solar energy available in transmission lines. New technologies such as intelligent PV farm management using the Power Plant Controller and an inverter-integrated communications interface aid in this development and help advance the integration of renewable energies into the global power distribution grids.

### Technology leader

Top-notch PV system technology and comprehensive project support anywhere in the world ensure that customers and project partners alike receive reliably high performance throughout the complete service life of their PV power station projects. Cooperation with SMA means maximum yields with the ultimate safety possible, yet keeping costs and any risks low for PV power station projects. Work with us and benefit from optimized profitability for your PV power station project in the process.



## SMA UTILITY GRADE

### Top-notch flexible system technology

SMA has developed an integrated approach in the implementation of utility-scale PV plants in the Power Plant Solutions business area. SMA Utility Grade combines advanced inverter solutions with a wide range of flexible system technologies and services for successfully implementing megawatt projects, in particular.

All partners will profit from SMA's extensive experience and knowledge in technological development, implementation planning and all related services.

#### **Flexible solutions**

SMA offers solutions for centralized and decentralized plant concepts. Customers can choose between individual components or even complete turnkey solutions such as MV stations or platforms. SMA also provides field-tested standard systems applying the same integrated and yield-oriented approach as it would for customized configurations for specific markets or customers. This includes the relevant software and monitoring solutions for monitoring and controlling large PV power stations.

#### **SMA stations and platforms**

The room-sized MV stations with one or two Sunny Central HE inverters are designed for direct medium-voltage feed-in. A peak efficiency of more than 98 percent is achieved using an amorphous transformer.





Heideblick PV farm, Gahro Military Airfield, 27.5 MW, project implemented by Enerparc (Sunny Central CP inverter)

## MV Power Platform

The MV Power Platform is the medium-voltage turnkey solution for the US market: the wiring of the configurable steel platform is pre-assembled, complies with NEC and NFPA-70E and is available as an open-air, covered or closed version. It can be used in temperatures ranging from -40 °C to +50 °C. It features two Sunny Central medium-voltage transformer with Disconnect Unit or Recombiner solutions, auxiliary power supply transformers and a variable Control & Supply panel, on which the customer's specific communications components, sub-distribution systems and other modifications can be implemented.

### Example of a turnkey MV Power Platform

#### Turnkey solution

- Modular, completely pre-wired solution with low installation costs
- Conversion, power distribution and control functions included
- Customizable service options

#### Innovative

- Based on award-winning SMA Sunny Central technology
- Trailblazing grid management functions available
- Nominal power at a max. of 110 percent

#### Secure

- Long-life cycle due to proven SMA production processes
- Service options address project-specific needs

#### Flexible

- Open-air, covered and closed construction options
- Installation possible on concrete slabs, on columns or in station basements

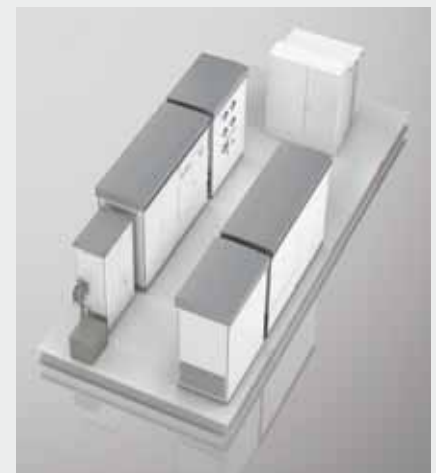



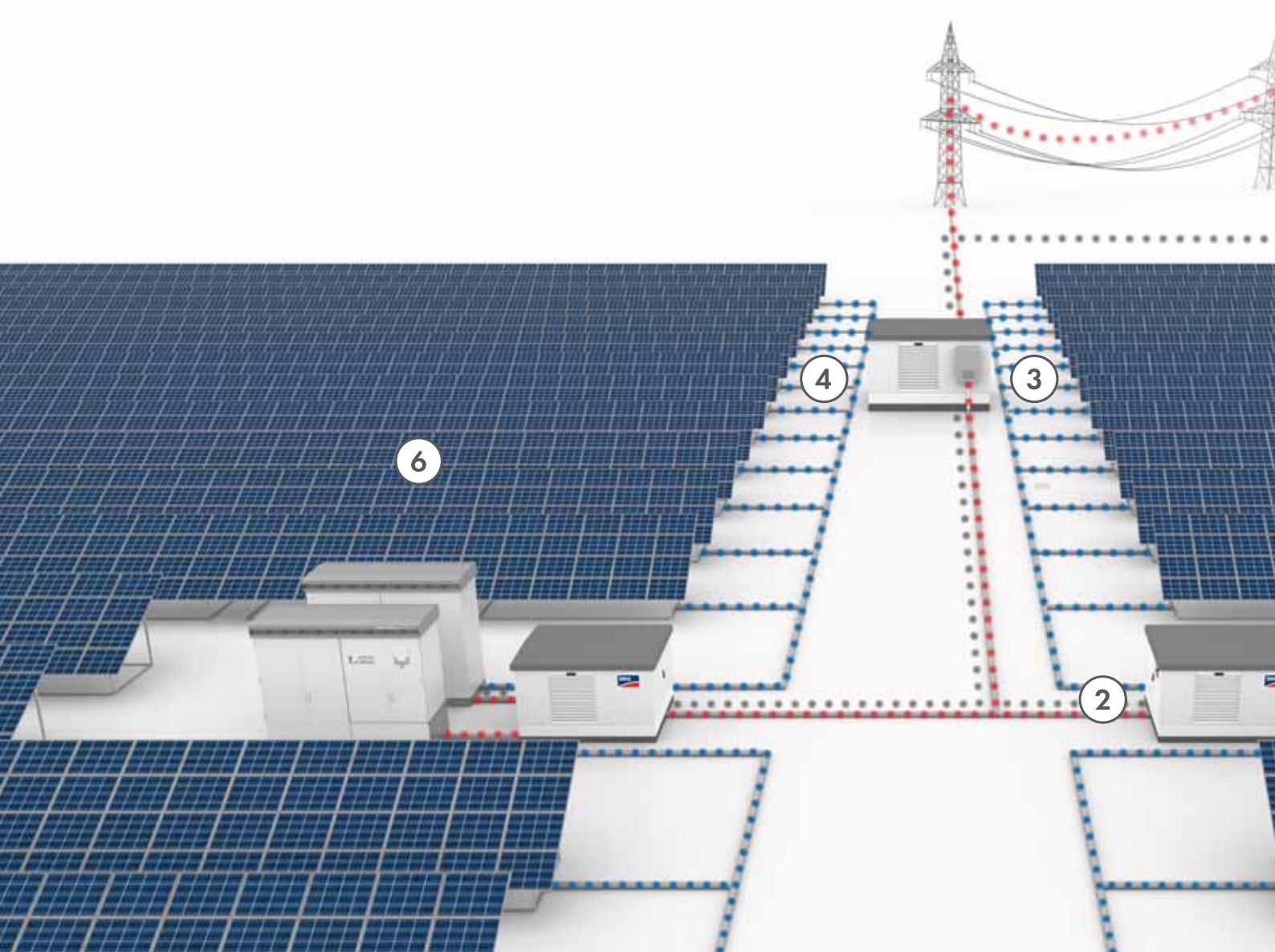

# Ensuring highest energy yields

## Bundled competencies in power plant projects

### Sunny Central

With the Sunny Central series, SMA offers central plant concepts intended specifically for high power classes. They are ideally suited for use in PV power stations with a homogenous structure thanks to their special properties.

Similar to turnkey PV power stations equipped with Sunny Central HE inverters, the outdoor devices of the CP series are extremely efficient. With an efficiency of over 98 percent, the Sunny Central 800CP is the most efficient

device in its class. The weatherproof enclosure and the lower weight enable it to be set up outdoors. As numerous stress tests show, the inverters are highly durable against extreme weather conditions.

### Sunny Tripower

The three-phase Sunny Tripower is ideally suited for decentralized plant architectures. Thanks to its new Optiflex technology with two MPP inputs and a very wide input voltage range, the Sunny Tripower is compatible with almost any module configuration. Its

reactive power capability contributes to the grid support. The Sunny Tripower 20000TL High Efficiency offers 99 percent efficiency and a modified input voltage range, making it the optimal choice for large-scale decentralized PV plant configurations.

### String-failure detection

Power plant operators have the possibility to monitor, regulate and optimize their yields and power plant functioning with intelligent solutions for plant monitoring and control.

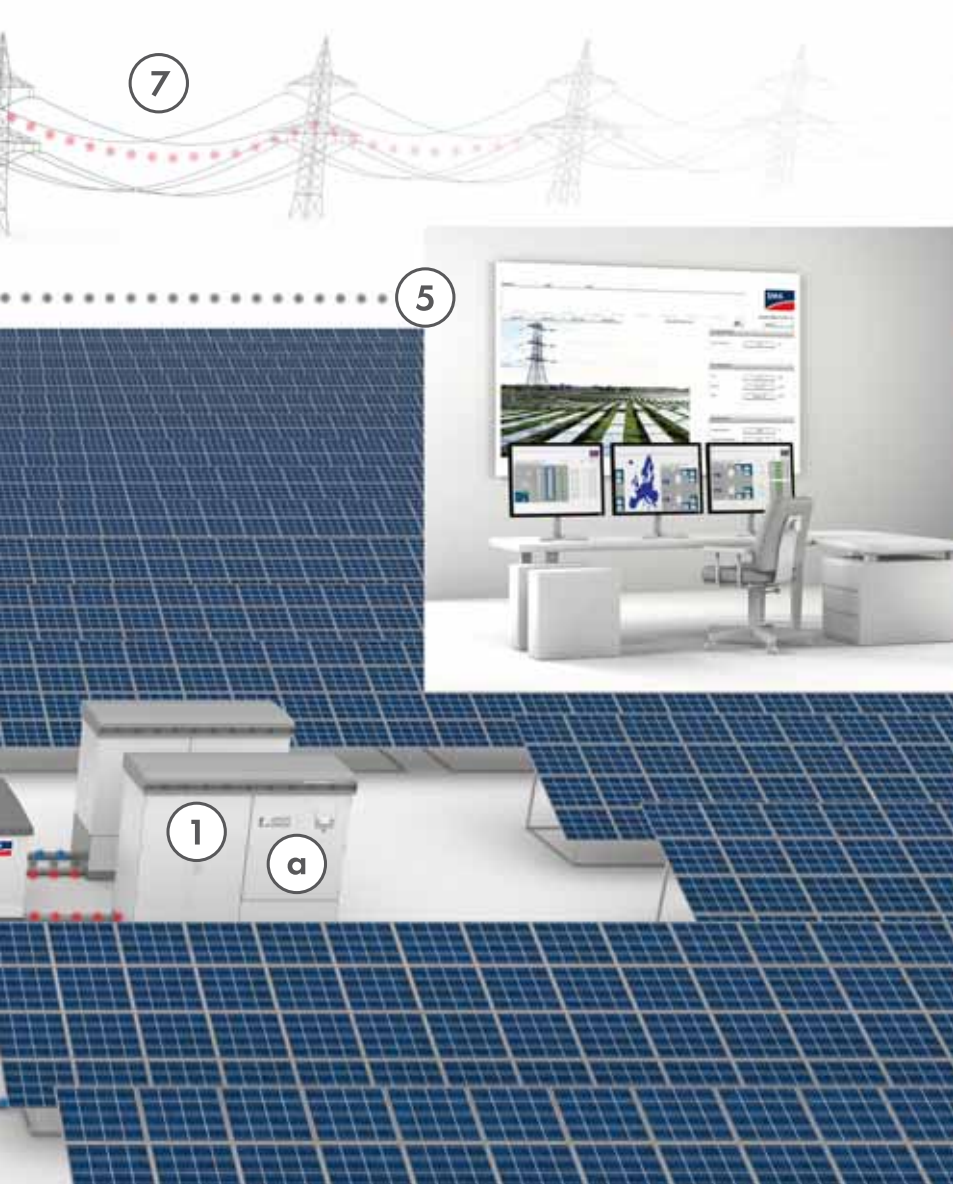

## Typical power plant configuration with SMA system technology

- ① SMA central inverters (Sunny Central CP series, also for outdoors) with
    - ⓐ Optiprotect (integrated string monitoring)
  - ② SMA Transformer Compact Station
  - ③ SMA Power Plant Controller
  - ④ Transfer station
  - ⑤ Control room from operator or electric utility company
  - ⑥ PV array (module field)
  - ⑦ Medium- or high-voltage grid
- Direct current  
(from the module field to inverter)
  - Alternating current  
(from the inverter into the power distribution grid)
  - SMA Power Plant Control System  
(plant monitoring and control)

The new Optiprotect technology, which is integrated centrally in the inverter, is used to reliably detect and handle errors in the PV field. Optiprotect offers a simple and cost-effective solution for monitoring and handling large-scale PV power stations, thanks to a combination of intelligent algorithm and motor-driven circuit breakers.

### Grid management

SMA system technology offers comprehensive yield monitoring while meeting all the requirements of the grid operator regarding

the provision of grid management. PV power stations dynamically react to all changes in the transmission line, convert grid operator's specifications in a fraction of a second depending on active or reactive power, and can delay the switching off of the plant.

### Grid stability

Thanks to the SMA Power Plant Controller, the PV power station is able to contribute actively to grid stability, a feat that conventional power plants could not fulfill because of their inertia. A PV power station with SMA

system technology does not only supply valuable energy at the peak load time around noon, it also contributes to the required grid stability because of its flexible controllability. Otherwise, this action would need to be purchased elsewhere. Power outages are reduced and the ability to forecast energy that is fed in improves.



# Power Plant Solutions

Flexible product portfolio

SMA central inverters fulfill the requirements of grid operators around the world and are the right product for any size or type of PV power station. The inverters guarantee you the highest possible yields at low costs when paired up with SMA's clever system technology. Efficient and flexible products from SMA, even as a component in a medium-voltage power plant. Comprehensive grid management functions and special features guarantee the highest possible yields and a profitable investment.

## ■ CENTRAL INVERTER and SYSTEM TECHNOLOGY



SC 500CP  
SC 630CP  
SC 720CP  
SC 760CP  
SC 800CP



TCS 500SC  
TCS 630SC  
TCS 800SC  
TCS 1000SC  
TCS 1250SC  
TCS 1600SC



SC 500HE-20  
SC 630HE-20  
SC 720HE-20  
SC 760HE-20  
SC 800HE-20



SC 1000MV-20  
SC 1250MV-20  
SC 1600MV-20



SC 500MV-20  
SC 630MV-20  
SC 800MV-20



SC 400HE-11  
SC 500HE-11  
SC 630HE-11



SC 400MV-11  
SC 500MV-11  
SC 630MV-11  
SC 800MV-11  
SC 1000MV-11  
SC 1250MV-11



SC 500CP-US  
SC 630CP-US  
SC 720CP-US  
SC 750CP-US  
SC 800CP-US



SC 500HE-US



SC 250-US  
SC 500-US



Disconnect Unit



Sunny String-Monitor



Sunny Central  
String-Monitor-US



Communit



■ Compatible products from the INVERTERS WITH/WITHOUT TRANSFORMER sections



STP 15000TLHE-10  
STP 20000TLHE-10



STP 10000TL-10  
STP 12000TL-10  
STP 15000TL-10  
STP 17000TL-10



SMC 9000TL-10  
SMC 10000TL-10  
SMC 11000TL-10  
SMC 9000LRP-10  
SMC 10000LRP-10  
SMC 11000LRP-10  
SMC 7000HV-11  
SMC 4600A-11  
SMC 5000A-11  
SMC 6000A-11



SB 6000TLUS-12  
SB 7000TLUS-12  
SB 8000TLUS-12  
SB 9000TLUS-12  
SB 10000TLUS-12  
SB 11000TLUS-12  
SB 5000US-12  
SB 6000US-12  
SB 6000US  
SB 7000US-12  
SB 7000US  
SB 8000US-12  
SB 8000US

■ Compatible products from the MONITORING SYSTEMS section



Sunny WebBox



Sunny Portal



Power Reducer Box



SMA OPC server



#### Economical

- Optiprotect for maximum plant availability
- Direct deployment in the field due to outdoor enclosure

#### Efficient

- Full nominal power at ambient temperatures up to 50 °C
- 10 % additional power in continuous operation at ambient temperatures up to 25 °C

#### Flexible

- DC voltage range configurable
- Optional: extended input voltage range up to 1100 V

#### Secure

- Easy and safe installation due to a separate connection area
- Powerful grid management functions (including LVRT)



## SUNNY CENTRAL 500CP / 630CP / 720CP / 760CP / 800CP

Ensuring highest energy yields

The Sunny Central CP series and Optiprotect not only save you a great amount of money, but also time and effort: Optiprotect integrates the self-learning string-failure detection in the inverter and centrally monitors up to 1,600 module strings without requiring conventional communication wiring in the field. The self-learning monitoring system simplifies commissioning significantly. 32 motor-driven, adjustable DC inputs ensure maximum plant availability. And thanks to its compact and weatherproof enclosure, the inverters can be loaded and transported with ease and set up almost anywhere.



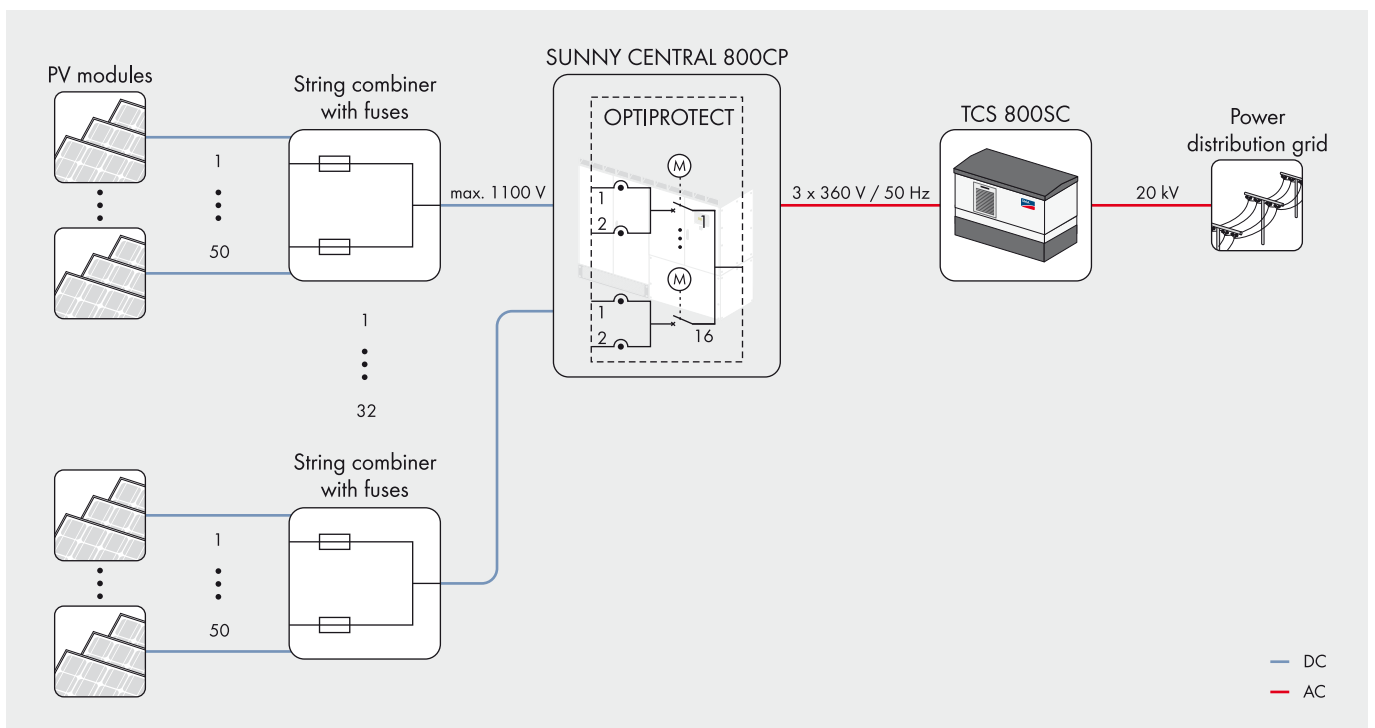
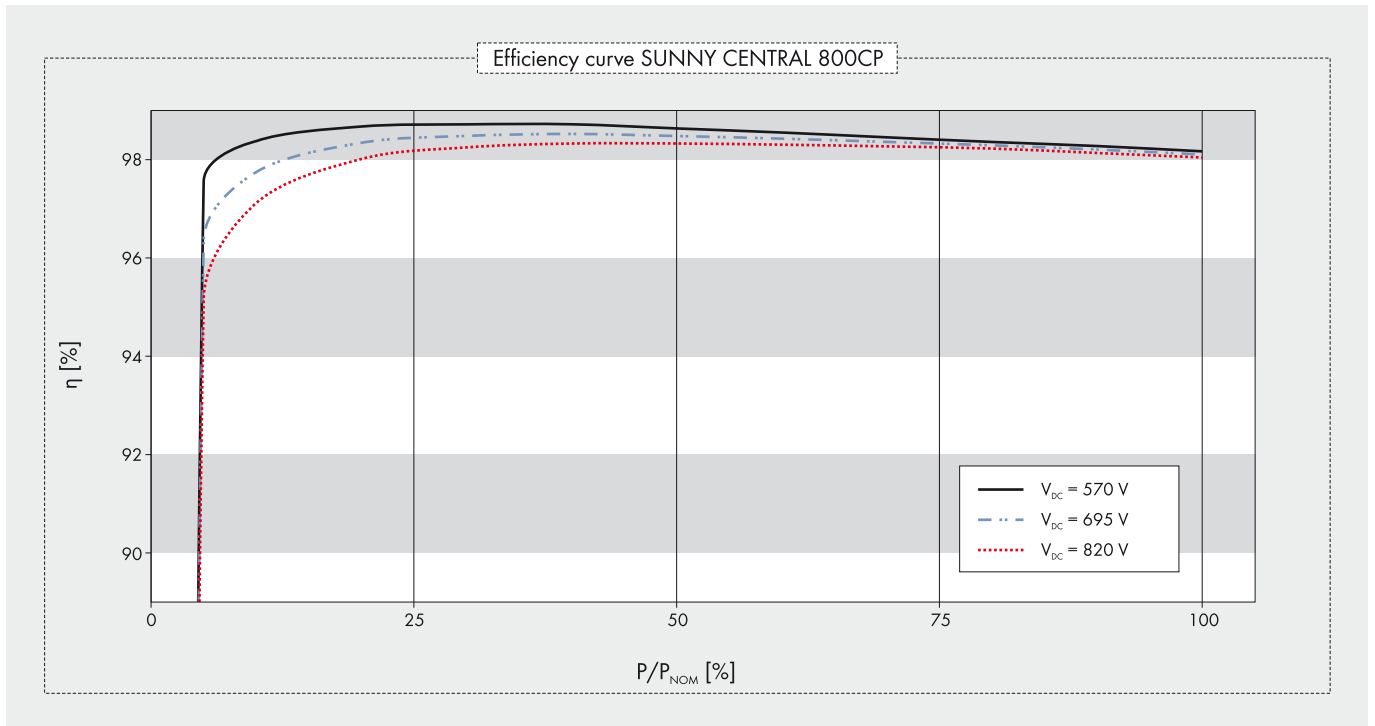

# SUNNY CENTRAL

## 500CP / 630CP / 720CP / 760CP / 800CP

Technical data	Sunny Central 500CP	Sunny Central 630CP
<b>Input (DC)</b>		
Max. DC power (@ cos φ = 1)	560 kW	713 kW
Max. input voltage <sup>1</sup>	1000 V / 1100 V optional	1000 V / 1100 V optional
MPP voltage range (@ 25 °C / @ 50 °C at 50 Hz)	449 V - 820 V / 430 V - 820 V <sup>2</sup>	529 V - 820 V / 500 V - 820 V <sup>2</sup>
MPP voltage range (@ 25 °C / @ 50 °C at 60 Hz)	449 V - 820 V / 436 V - 820 V <sup>2</sup>	529 V - 820 V / 505 V - 820 V <sup>2</sup>
Rated input voltage	480 V	550 V
Max. input current	1250 A	1350 A
Min. input voltage / V <sub>MPP_min</sub> at I <sub>MPP</sub> < I <sub>DCmax</sub>	429 V / 430 V	498 V / 500 V
Number of independent MPP inputs	1	1
Number of DC inputs	9 / 32 (Optiprotect)	9 / 32 (Optiprotect)
<b>Output (AC)</b>		
Rated power (@ 25 °C) / nominal AC power (@ 50 °C)	550 kVA / 500 kVA	700 kVA / 630 kVA
Nominal AC voltage / nominal AC voltage range	270 V / 243 V - 297 V	315 V / 284 V - 347 V
AC power frequency / range	50 Hz, 60 Hz / 47 Hz ... 63 Hz	50 Hz, 60 Hz / 47 Hz ... 63 Hz
Rated power frequency / rated grid voltage	50 Hz / 270 V	50 Hz / 315 V
Max. output current	1176 A	1283 A
Max. total harmonic factor	< 3 %	< 3 %
Power factor at rated power / displacement power factor adjustable	1 / 0.9 overexcited ... 0.9 underexcited	
Feed-in phases / connection phases	3 / 3	3 / 3
<b>Efficiency<sup>7</sup></b>		
Max. efficiency / European weighted efficiency / CEC efficiency	98.6 % / 98.4 % / 98.5 %	98.7 % / 98.5 % / 98.5 %
<b>Protective devices</b>		
DC disconnect device	Motor-driven DC switch-disconnector / circuit breaker (Optiprotect)	
AC disconnect device	AC circuit breaker	
DC overvoltage protection	Type I surge arrester	
Lightning protection (according to IEC 62305-1)	Lightning protection level III	Lightning protection level III
Grid monitoring	●	●
Ground-fault monitoring / remote-controlled ground-fault monitoring	○ / ○	○ / ○
Insulation monitoring	○	○
Surge arresters for auxiliary power supply	●	●
Protection class (according to IEC 62103) / overvoltage category (according to IEC 60664-1)	I / III	I / III
<b>General data</b>		
Dimensions (W / H / D)	2562 / 2279 / 956 mm (101 / 90 / 38 inch)	
Weight	1800 kg / 4000 lb	1800 kg / 4000 lb
Operating temperature range	-20 °C ... +50 °C / -4 °F ... +122 °F	-20 °C ... +50 °C / -4 °F ... +122 °F
Noise emission <sup>5</sup>	60 db(A)	60 db(A)
Max. self-consumption (operation) / self-consumption (night)	1700 W <sup>4</sup> / < 100 W	1700 W <sup>4</sup> / < 100 W
External auxiliary supply voltage	230 / 400 V (3/N/PE)	230 / 400 V (3/N/PE)
Cooling concept	OptiCool	OptiCool
Degree of protection: electronics / connection area (according to IEC 60529)	IP54 / IP43	IP54 / IP43
Degree of protection (according to IEC 60721-3-4)	4C2, 4S2	4C2, 4S2
Application	In unprotected outdoor environments	In unprotected outdoor environments
Max. permissible value for relative humidity (non-condensing)	15 % ... 95 %	15 % ... 95 %
Max. operating altitude above MSL	2000 m	2000 m
Fresh-air consumption (inverter)	3000 m <sup>3</sup> /h	3000 m <sup>3</sup> /h
<b>Features</b>		
DC connection	Ring terminal lug / cage clamp (Optiprotect)	
AC connection	Ring terminal lug	Ring terminal lug
Display	HMI touchscreen	HMI touchscreen
Communication / protocols	Ethernet (optical fiber optional), Modbus	Ethernet (optical fiber optional), Modbus
Communication with Sunny String-Monitor	RS485 / none (Optiprotect)	RS485 / none (Optiprotect)
Sunny WebBox / SC-COM	● / ○	● / ○
Color enclosure / door / base / roof	RAL 9016 / 9016 / 7005 / 7004	
Warranty: 5 / 10 / 15 / 20 / 25 years	● / ○ / ○ / ○ / ○	● / ○ / ○ / ○ / ○
Certificates and approvals (more available on request)	EN 61000-6-2, EN 61000-6-4, CE compliant, Renewable Energy Source Act-compliant, BDEW-MSRL / FGW / TR8 <sup>6</sup> , Arrêté du 23/04/08, R.D. 1663 / 2000, R.D. 661 / 2007	
● Standard feature ○ Optional feature – Not available		
Type designation	SC 500CP-10	SC 630CP-10

- <sup>1</sup> Start-up at DC voltage < 1000 V
- <sup>2</sup> At 1.05 V<sub>AC, nom</sub> and cos φ = 1
- <sup>3</sup> Further AC voltages, DC voltages and power classes can be configured (for more detailed information, see technical information "Innovations\_CP" at www.SMA.de)
- <sup>4</sup> Self-consumption at rated operation
- <sup>5</sup> Sound pressure level at a distance of 10 m
- <sup>6</sup> With complete dynamic grid support
- <sup>7</sup> Efficiency measured without auxiliary power supply

Sunny Central 720CP	Sunny Central 760CP	Sunny Central 800CP	
808 kW	853 kW	898 kW	
1000 V / 1100 V optional	1000 V / 1100 V optional	1000 V / 1100 V optional	
577 V - 820 V / 525 V - 820 V <sup>2, 3</sup>	609 V - 820 V / 554 V - 820 V <sup>2, 3</sup>	641 V - 820 V / 583 V - 820 V <sup>2, 3</sup>	
577 V - 820 V / 525 V - 820 V <sup>2, 3</sup>	609 V - 820 V / 554 V - 820 V <sup>2, 3</sup>	641 V - 820 V / 583 V - 820 V <sup>2, 3</sup>	
565 V	595 V	620 V	
1400 A	1400 A	1400 A	
515 V / 515 V	545 V / 545 V	568 V / 570 V	
1	1	1	
9 / 32 (Optiprotect)	9 / 32 (Optiprotect)	9 / 32 (Optiprotect)	
792 kVA / 720 kVA	836 kVA / 760 kVA	880 kVA / 800 kVA	
324 V / 292 V - 356 V <sup>3</sup>	342 V / 308 V - 376 V <sup>3</sup>	360 V / 324 V - 396 V <sup>3</sup>	
50 Hz, 60 Hz / 47 Hz ... 63 Hz	50 Hz, 60 Hz / 47 Hz ... 63 Hz	50 Hz, 60 Hz / 47 Hz ... 63 Hz	
50 Hz / 324 V	50 Hz / 342 V	50 Hz / 360 V	
1411 A	1411 A	1411 A	
< 3 %	< 3 %	< 3 %	
1 / 0.9 overexcited ... 0.9 underexcited			
3 / 3	3 / 3	3 / 3	
98.6 % / 98.4 % / 98.5 %	98.6 % / 98.4 % / 98.5 %	98.6 % / 98.4 % / 98.5 %	
Motor-driven DC switch-disconnector / circuit breaker (Optiprotect)			
AC circuit breaker			
Type I surge arrester			
Lightning protection level III	Lightning protection level III	Lightning protection level III	
●	●	●	
○ / ○	○ / ○	○ / ○	
○	○	○	
●	●	●	
I / III	I / III	I / III	
2562 / 2279 / 956 mm (101 / 90 / 38 inch)			
1800 kg / 4000 lb	1800 kg / 4000 lb	1800 kg / 4000 lb	
-20 °C ... +50 °C / -4 °F ... +122 °F	-20 °C ... +50 °C / -4 °F ... +122 °F	-20 °C ... +50 °C / -4 °F ... +122 °F	
60 db(A)	60 db(A)	61 db(A)	
1700 W <sup>4</sup> / < 100 W	1700 W <sup>4</sup> / < 100 W	1700 W <sup>4</sup> / < 100 W	
230 / 400 V (3/N/PE)	230 / 400 V (3/N/PE)	230 / 400 V (3/N/PE)	
OptiCool	OptiCool	OptiCool	
IP54 / IP43	IP54 / IP43	IP54 / IP43	
4C2, 4S2	4C2, 4S2	4C2, 4S2	
In unprotected outdoor environments	In unprotected outdoor environments	In unprotected outdoor environments	
15 % ... 95 %	15 % ... 95 %	15 % ... 95 %	
2000 m	2000 m	2000 m	
3000 m <sup>3</sup> /h	3000 m <sup>3</sup> /h	3000 m <sup>3</sup> /h	
Ring terminal lug / cage clamp (Optiprotect)			
Ring terminal lug	Ring terminal lug	Ring terminal lug	
HMI touchscreen	HMI touchscreen	HMI touchscreen	
Ethernet (optical fiber optional), Modbus	Ethernet (optical fiber optional), Modbus	Ethernet (optical fiber optional), Modbus	
RS485 / none (Optiprotect)	RS485 / none (Optiprotect)	RS485 / none (Optiprotect)	
● / ○	● / ○	● / ○	
RAL 9016 / 9016 / 7005 / 7004			
● / ○ / ○ / ○ / ○	● / ○ / ○ / ○ / ○	● / ○ / ○ / ○ / ○	
EN 61000-6-2, EN 61000-6-4, EMC compliant, CE compliant, BDEW-MSRL / FGW / TR8 <sup>6</sup> , Arrêté du 23/04/08, R.D. 1663 / 2000, R.D. 661 / 2007			
SC 720CP-10	SC 760CP-10	SC 800CP-10	



#### Reliable

- Simplified transport due to low weight
- Significant savings in PV farm road construction

#### Simple

- Complete turnkey solution in concrete construction
- Ideally suited for the central inverters of the CP series

#### Innovative

- Optimal steel enclosure for even easier transport
- Amorphous transformer for minimal open-circuit losses

#### Extendable

- Medium-voltage switchgear for modular construction of PV farms
- Transformer for internal power to supply the inverter



## TRANSFORMER COMPACT STATION

**500SC / 630SC / 800SC / 1000SC / 1250SC / 1600SC**

Compact for medium voltage

The new Transformer Compact Station is the ideal link between SMA central inverters and the medium-voltage grid. As a complete turnkey solution in a concrete design, it provides all options – from medium-voltage switchgear to amorphous transformer with greatly reduced open-circuit losses. In steel design, it is also significantly smaller and lighter than the previous solutions, saving time and money. The Transformer Compact Station 1600SC includes as standard equipment an adjustable voltage tap that can be controlled easily with a rotary switch, making the device an ideal companion for the central inverters from the CP series.

**OPTIONS**

**Amorphous transformer**

A transformer with amorphous core reduces open-circuit losses by approximately 70 percent compared to a transformer with an iron core (loss class C). For example, open-circuit losses of a 1,600 kVA transformer with iron core: 1,700 W. Open-circuit losses with an amorphous core: 510 W. Energy savings in 20 years: approximately 200,000 kWh.

**Medium-voltage switchgear**

Using medium-voltage switchgear, several transformer stations can be connected in a string or a ring. This allows modular construction of large PV farms.

**Communit**

The Communit communication distributor is designed to house and wire together all communication components used in large-scale PV plants with SUNNY CENTRAL.

**Transformer for auxiliary power supply**

A transformer for auxiliary power supplies the transformer station and the attached inverters directly from the medium-voltage grid.

**Steel enclosure**

With the compact and light steel enclosure, the weight of the transformer station is reduced by 50 to 75 percent, meaning easier and less expensive transport.

**Low-voltage switchgear**

On demand, the standard LV/HRC fuse switch-disconnectors can be replaced by circuit breakers.

**Use in a chemically aggressive environment**

If desired, the TRANSFORMER COMPACT STATION can be optimized for use in a chemically aggressive environment, such as for seaside installation.

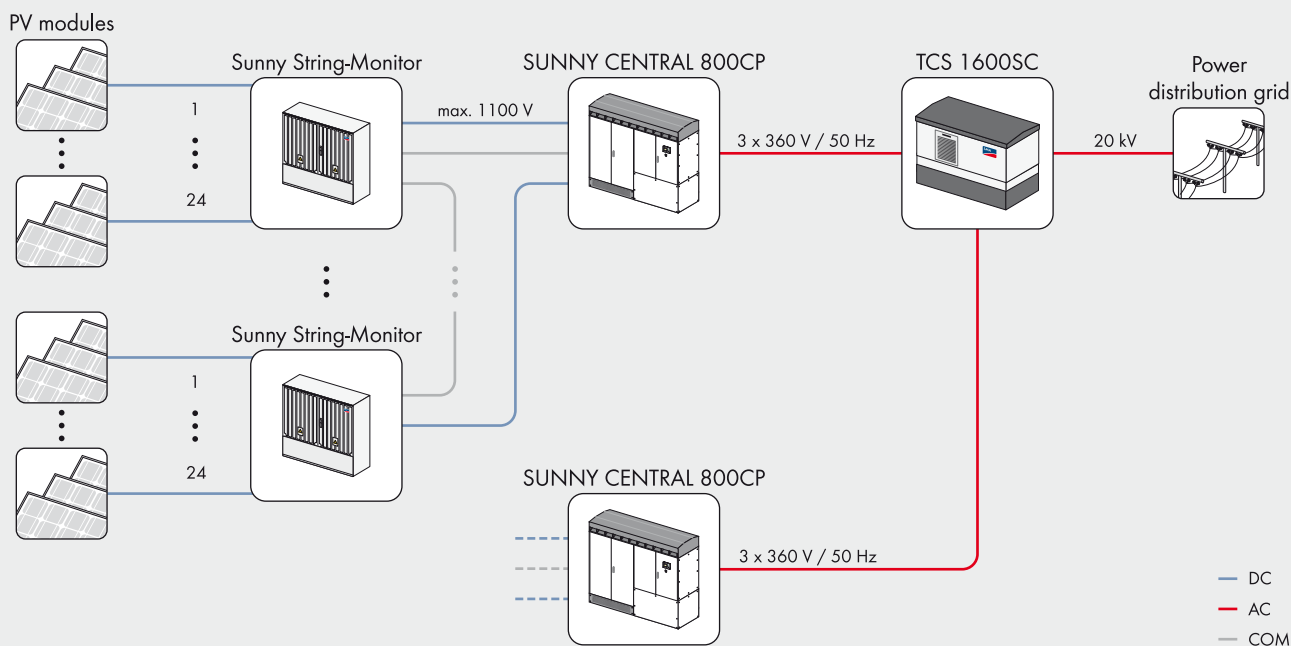









#### Powerful

- Excellent specific price
- Full nominal power up to 50 °C
- 10 % additional power in continuous operation at ambient temperatures up to 25 °C

- Efficiency of more than 98 %
- Peak output up to max. 880 kVA
- Comprehensive grid management functions including complete dynamic grid support (LVRT)

#### Flexible

- Flexible plant design due to input voltage up to 1000 V as standard
- Open communication interfaces, for example, ModBus, OPC

#### Simple

- Optimized connection area
- Customer-friendly operation thanks to the color touch display
- Minimized installation costs thanks to a simpler scope of delivery



## SUNNY CENTRAL 500HE / 630HE / 720HE / 760HE / 800HE

Highest performance for PV power stations

High flexibility in plant design and minimal systems costs with even more power: the proven High Efficiency series for direct connection to the medium-voltage transformer has once again been improved and complies with the complex demands of PV plants on the scale of power stations. This means that the maximum power in continuous operation has been increased by ten percent compared to the nominal power for as long as the ambient temperature does not exceed 25 °C. At the same time, the devices offer comprehensive grid management functions, including immediate reconnection after a grid voltage drop. The device class can be simply expanded and connected via several communication interfaces.

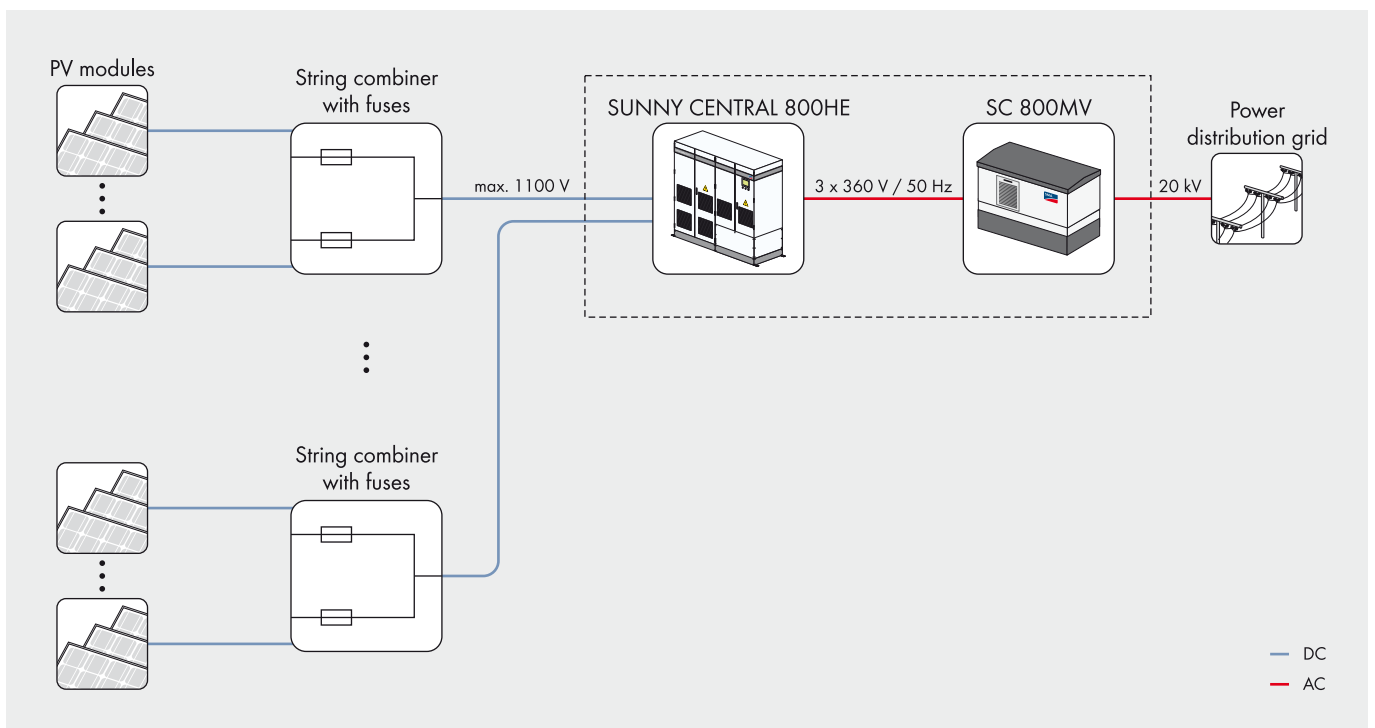
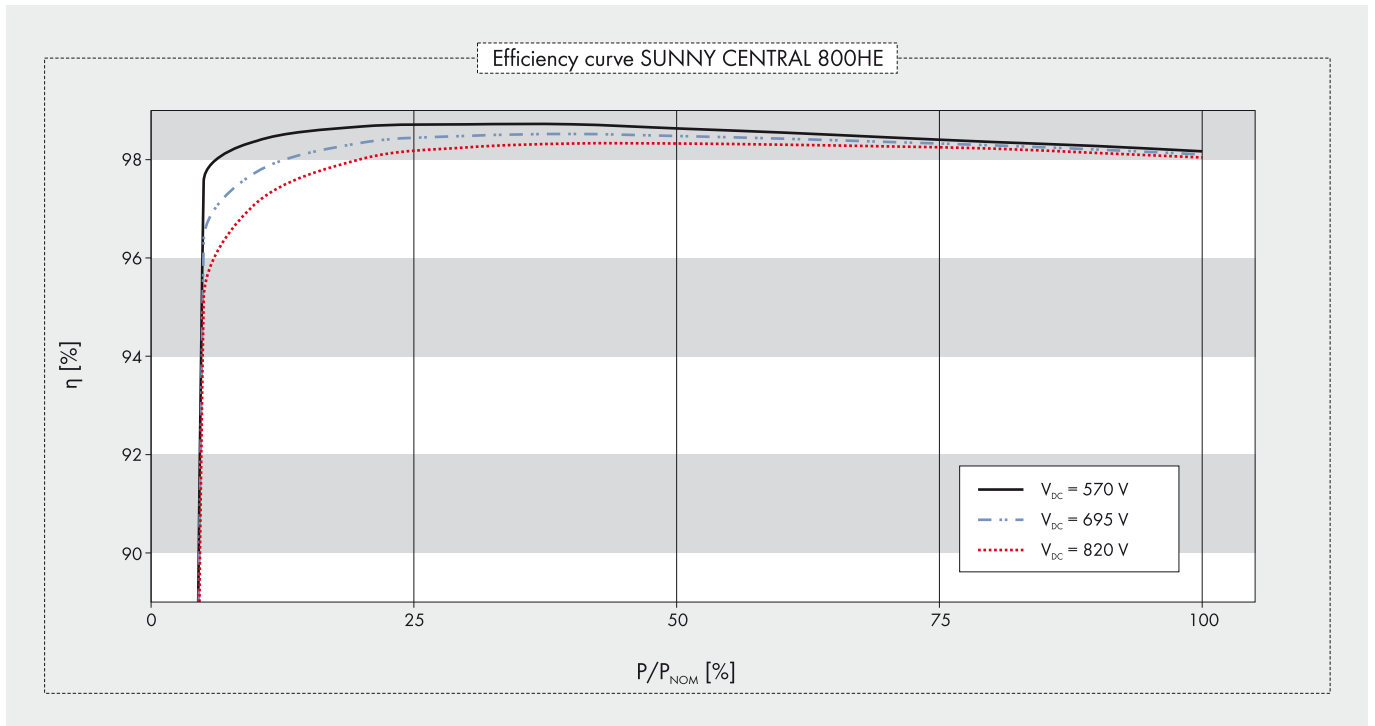

# SUNNY CENTRAL 500HE / 630HE / 720HE / 760HE / 800HE

Technical data	Sunny Central 500HE	Sunny Central 630HE
<b>Input (DC)</b>		
Max. DC power (@ cos φ = 1)	560 kW	713 kW
Max. input voltage <sup>1</sup>	1000 V / 1100 V optional	1000 V / 1100 V optional
MPP voltage range (@ 25 °C / @ 50 °C at 50 Hz)	449 V - 820 V / 430 V - 820 V <sup>2</sup>	529 V - 820 V / 500 V - 820 V <sup>2</sup>
MPP voltage range (@ 25 °C / @ 50 °C at 60 Hz)	449 V - 820 V / 436 V - 820 V <sup>2</sup>	529 V - 820 V / 505 V - 820 V <sup>2</sup>
Rated input voltage	480 V	550 V
Max. input current	1250 A	1350 A
Min. input voltage / V <sub>MPP,min</sub> at I <sub>MPP</sub> < I <sub>DC,max</sub>	429 V / 430 V	498 V / 500 V
Number of independent MPP inputs	1	1
Number of DC inputs	9 inputs equipped with fuses	9 inputs equipped with fuses
<b>Output (AC)</b>		
Rated power (@ 25 °C) / nominal AC power (@ 50 °C)	550 kVA / 500 kVA	700 kVA / 630 kVA
Nominal AC voltage / range	270 V / 243 V - 297 V	315 V / 284 V - 347 V
AC power frequency / range	50 Hz, 60 Hz / 47 Hz ... 63 Hz	50 Hz, 60 Hz / 47 Hz ... 63 Hz
Rated power frequency / rated grid voltage	50 Hz / 270 V	50 Hz / 315 V
Max. output current	1176 A	1283 A
Max. total harmonic factor	< 3 %	< 3 %
Power factor at rated power / displacement power factor adjustable	1 / 0.9 overexcited ... 0.9 underexcited	
Feed-in phases / connection phases	3 / 3	3 / 3
<b>Efficiency<sup>6</sup></b>		
Max. efficiency / European weighted efficiency / CEC efficiency	98.6 % / 98.4 % / 98.5 %	98.7 % / 98.5 % / 98.5 %
<b>Protective devices</b>		
DC disconnect device	Motor-driven DC circuit breaker	
AC disconnect device	AC circuit breaker	
DC overvoltage protection	Type I surge arrester	
Lightning protection level (according to IEC 62305-1)/grid monitoring	Lightning protection level III / ●	Lightning protection level III / ●
Plant monitoring	Optionally (via Sunny Portal)	Optionally (via Sunny Portal)
Ground-fault monitoring / remote-controlled ground-fault monitoring	○ / ○	○ / ○
Insulation monitoring	○	○
Surge arresters for auxiliary power supply	●	●
Protection class (according to IEC 62103) / overvoltage category (according to IEC 60664-1)	I / III	I / III
<b>General data</b>		
Dimensions (W / H / D)	2510 / 2093 / 950 mm (98.9 / 82.4 / 37.4 inch)	
Weight	1670 kg / 3681.7 lb	1670 kg / 3681.7 lb
Operating temperature range	-20 °C ... +50 °C / -4 °F ... +122 °F	-20 °C ... +50 °C / -4 °F ... +122 °F
Noise emission <sup>7</sup>	59.4 db(A)	61.4 db(A)
Max. self-consumption (operation) / self-consumption (night)	1500 W <sup>4</sup> / < 100 W	1500 W <sup>4</sup> / < 100 W
External auxiliary supply voltage	230 / 400 V (3/N/PE)	230 / 400 V (3/N/PE)
Cooling concept	Forced cooling	Forced cooling
Degree of protection: electronics / connection area (according to IEC 60529)	IP21/IP43	IP21/IP43
Application	Not air-conditioned indoors	Not air-conditioned indoors
Max. permissible value for relative humidity (non-condensing)	15 % ... 95 %	15 % ... 95 %
Max. operating altitude above MSL	2000 m	2000 m
Fresh-air consumption	3000 m <sup>3</sup> /h	3000 m <sup>3</sup> /h
<b>Features</b>		
DC connection	Ring terminal lug	Ring terminal lug
AC connection	Ring terminal lug	Ring terminal lug
SC-COM	●	●
Display	HMI touchscreen	HMI touchscreen
Communication / protocols	Ethernet, Modbus	Ethernet, Modbus
Sunny String-Monitor	RS485 / none (Optiprotect)	RS485 / none (Optiprotect)
Color enclosure / door / base / roof	RAL 7035/7035/7024/7035	
Warranty: 5 / 10 / 15 / 20 / 25 years	● / ○ / ○ / ○ / ○	
Certificates and approvals (more available on request)	EN 61000-6-2, EN 61000-6-4, Renewable Energy Sources Act-compliant, Arrêté du 23/04/08, R.D. 1663 / 2000, R.D. 661 / 2007, BDEW-MSRL/FGW/TR8 <sup>5</sup>	
Classification of ambient conditions (according to IEC 60721-3-3)	3C1L, 3S2, 3B1, 3K6, 3M1	
● Standard feature ○ Optional feature – Not available		
Type designation	SC 500HE-20	SC 630HE-20



- <sup>1</sup> Start-up at DC voltage < 1000 V
- <sup>2</sup> At 1.05 V<sub>AC, nom</sub> and cos φ = 1
- <sup>3</sup> Further AC voltages, DC voltages and power classes can be configured (for more detailed information, see Technical Information "Innovations\_CP" at www.SMA.de)
- <sup>4</sup> Self-consumption at rated operation
- <sup>5</sup> With complete dynamic grid support
- <sup>6</sup> Efficiency measured without auxiliary power supply
- <sup>7</sup> Sound pressure level at a distance of 10 m

Sunny Central 720HE	Sunny Central 760HE	Sunny Central 800HE	
808 kW	853 kW	898 kW	
1000 V / 1100 V optional	1000 V / 1100 V optional	1000 V / 1100 V optional	
577 V - 820 V / 525 V - 820 V <sup>2,3</sup>	609 V - 820 V / 554 V - 820 V <sup>2,3</sup>	641 V - 820 V / 583 V - 820 V <sup>2,3</sup>	
577 V - 820 V / 525 V - 820 V <sup>2,3</sup>	609 V - 820 V / 554 V - 820 V <sup>2,3</sup>	641 V - 820 V / 583 V - 820 V <sup>2,3</sup>	
565 V	595 V	620 V	
1400 A	1400 A	1400 A	
515 V / 515 V	545 V / 545 V	568 V / 570 V	
1	1	1	
9 inputs equipped with fuses	9 inputs equipped with fuses	9 inputs equipped with fuses	
792 kVA / 720 kVA	836 kVA / 760 kVA	880 kVA / 800 kVA	
324 V / 292 V - 356 V	342 V / 308 V - 376 V	360 V / 324 V - 396 V	
50 Hz, 60 Hz / 47 Hz ... 63 Hz	50 Hz, 60 Hz / 47 Hz ... 63 Hz	50 Hz, 60 Hz / 47 Hz ... 63 Hz	
50 Hz / 324 V	50 Hz / 342 V	50 Hz / 360 V	
1411 A	1411 A	1411 A	
< 3 %	< 3 %	< 3 %	
	1 / 0.9 overexcited ... 0.9 underexcited		
3 / 3	3 / 3	3 / 3	
98.6 % / 98.4 % / 98.5 %	98.6 % / 98.4 % / 98.5 %	98.6 % / 98.4 % / 98.5 %	
Motor-driven DC switch-disconnector			
AC circuit breaker			
Type I surge arrester			
Lightning protection level III / ●	Lightning protection level III / ●	Lightning protection level III / ●	
Optionally (via Sunny Portal)	Optionally (via Sunny Portal)	Optionally (via Sunny Portal)	
○ / ○	○ / ○	○ / ○	
○	○	○	
●	●	●	
I / III	I / III	I / III	
2510 / 2093 / 950 mm (98.9 / 82.4 / 37.4 inch)			
1670 kg / 3681.7 lb	1670 kg / 3681.7 lb	1670 kg / 3681.7 lb	
-20 °C ... +50 °C / -4 °F ... +122 °F	-20 °C ... +50 °C / -4 °F ... +122 °F	-20 °C ... +50 °C / -4 °F ... +122 °F	
62 db(A)	62.4 db(A)	62.6 db(A)	
1500 W <sup>4</sup> / 100 W	1500 W <sup>4</sup> / < 100 W	1500 W <sup>4</sup> / < 100 W	
230 / 400 V (3/N/PE)	230 / 400 V (3/N/PE)	230 / 400 V (3/N/PE)	
Forced cooling	Forced cooling	Forced cooling	
IP21/IP43	IP21/IP43	IP21/IP43	
Not air-conditioned indoors	Not air-conditioned indoors	Not air-conditioned indoors	
15 % ... 95 %	15 % ... 95 %	15 % ... 95 %	
2000 m	2000 m	2000 m	
3000 m <sup>3</sup> /h	3000 m <sup>3</sup> /h	3000 m <sup>3</sup> /h	
Ring terminal lug	Ring terminal lug	Ring terminal lug	
Ring terminal lug	Ring terminal lug	Ring terminal lug	
●	●	●	
HMI touchscreen	HMI touchscreen	HMI touchscreen	
Ethernet, Modbus	Ethernet, Modbus	Ethernet, Modbus	
RS485 / none (Optiprotect)	RS485 / none (Optiprotect)	RS485 / none (Optiprotect)	
RAL 7035/7035/7024/7035			
● / ○ / ○ / ○ / ○			
EN 61000-6-2, EN 61000-6-4, EMC compliant, CE compliant, Arrêté du 23/04/08, R.D. 1663 / 2000, R.D. 661 / 2007, BDEW-MSRL / FGW / TR8 <sup>6</sup>			
3C1L, 3S2, 3B1, 3K6, 3M1			
SC 720HE-20	SC 760HE-20	SC 800HE-20	



#### Powerful

- Peak output of up to 1,760 kVA
- Turnkey solution for direct connection to the medium-voltage grid

#### High yields plus reliability

- Max. yields thanks to an optimized AC power path
- Comprehensive grid management functions including complete dynamic grid support (BDEW compliant)

#### Communicative

- High-performance industrial PC with a range of integrated interfaces
- Open communication interfaces, for example, Modbus, OPC

#### Flexible

- Medium-voltage switchgear systems for flexibly designing large PV farms
- Amorphous transformer for minimal open-circuit losses
- Use in a chemically aggressive environment



## SUNNY CENTRAL for direct medium-voltage feed-in 1000MV / 1250MV / 1600MV

High-performance medium-voltage station in the power plant class

For even more power per surface area: up to two high-performance Sunny Central HE-20 are part of a medium-voltage station (MV) that feeds directly into a shared medium-voltage transformer. This transforms two Sunny Central 800HE inverters, for example, into one Sunny Central 1600MV station. A peak efficiency of more than 98 percent is achieved using an amorphous transformer. The new MV station integrates high-performance communications components and also requires even less maintenance. Moreover, the new MV station offers extensive grid management functions and fulfills all of the requirements of the medium-voltage directive.

## OPTIONS

### Amorphous transformer

A transformer with amorphous core reduces open-circuit losses by approximately 70 percent compared to a transformer with an iron core (loss class C).

For example, open-circuit losses of a 1600 kVA transformer with an iron core: 1700 W open-circuit losses with amorphous core: 510 W. Energy gain in 20 years: around 200,000 kWh.

### Medium-voltage switchgear

Using medium-voltage switchgear, several SUNNY CENTRAL MV stations can be connected in a string or a ring. This allows modular construction of large PV farms.

### Transformer for auxiliary power supply

An auxiliary power supply transformer (6 kVA) allows the supply of the SUNNY CENTRAL MV Station from the medium-voltage grid.

### Use in a chemically aggressive environment

If desired, the SUNNY CENTRAL MV Station can be optimized for use in a chemically aggressive environment, such as for seaside installation.

### Communit

The Communit communication distributor is designed to house and wire together all communication components used in large-scale PV plants with SUNNY CENTRAL.

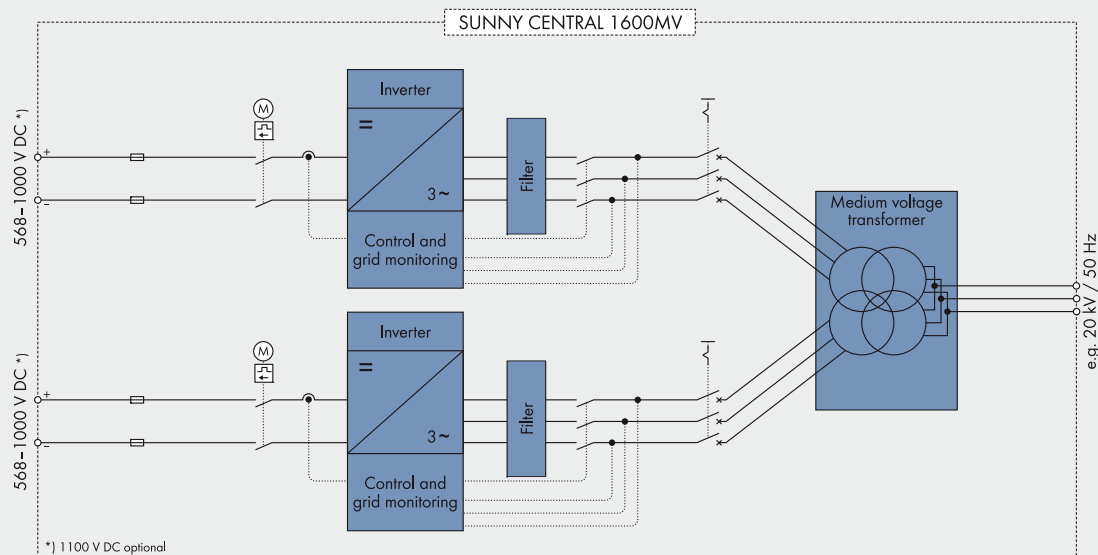
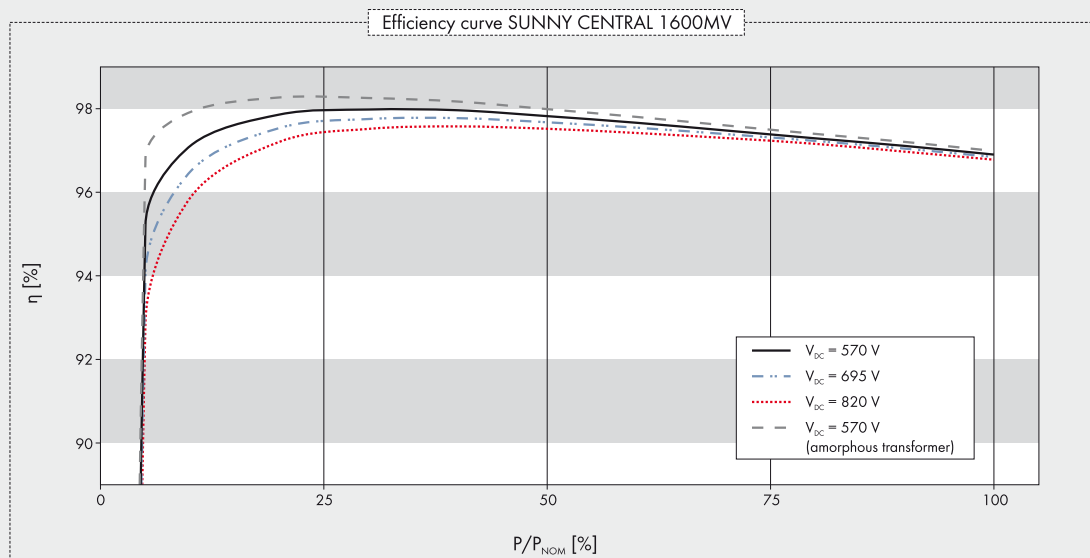

# SUNNY CENTRAL for direct medium-voltage feed-in

## 1000MV / 1250MV / 1600MV

Technical data	Sunny Central 1000MV	Sunny Central 1250MV
<b>Input (DC)</b>		
Max. DC power (@ cos φ = 1)	1120 kW	1426 kW
Max. input voltage <sup>1</sup>	1000 V / 1100 V optional	1000 V / 1100 V optional
MPP voltage range (@ 25 °C / @ 40 °C at 50 Hz) <sup>2</sup>	449 V – 820 V / 430 V – 820 V	529 V – 820 V / 500 V – 820 V
Rated input voltage	480 V	550 V
Max. input current	2500 A	2700 A
Min. input voltage / V <sub>MPP_min</sub> at I <sub>MPP</sub> < I <sub>DC_max</sub>	429 V / 430 V	498 V / 500 V
Number of independent MPP inputs	2	2
Number of DC inputs	18 inputs equipped with fuses	18 inputs equipped with fuses
<b>Output (AC)</b>		
Rated power (@ 25 °C) / nominal AC power (@ 40 °C)	1100 kVA / 1000 kVA	1400 kVA / 1250 kVA
Nominal AC voltage / range	20000 V / 18000 V – 22000 V	20000 V / 18000 V – 22000 V
AC power frequency / range	50 Hz / 47 Hz ... 53 Hz	50 Hz / 47 Hz ... 53 Hz
Rated power frequency / rated grid voltage	50 Hz / 20000 V	50 Hz / 20000 V
Max. output current	31.8 A	40.4 A
Max. total harmonic factor	< 3 %	< 3 %
Power factor at rated power / displacement power factor adjustable <sup>3</sup>	1 / 0.9 overexcited ... 0.9 underexcited	
Feed-in phases / connection phases	3 / 3	3 / 3
<b>Efficiency<sup>4</sup></b>		
Max. efficiency	98 % (98.2 %) <sup>5</sup>	98 % (98.2 %) <sup>5</sup>
European weighted efficiency / CEC efficiency	97.5 % (97.8 %) <sup>5</sup>	97.6 % (97.8 %) <sup>5</sup>
<b>Protective devices</b>		
DC disconnect device	Motor-driven DC switch-disconnector	
AC disconnect device	Optionally (switch-disconnector with HH fuses)	
DC overvoltage protection / AC overvoltage protection on the LV side	Surge arrester type I / surge arrester type II	
Grid monitoring / plant monitoring	● / Optionally (via Sunny Portal)	● / Optionally (via Sunny Portal)
Ground-fault monitoring / remote-controlled ground-fault monitoring	○ / ○	○ / ○
Insulation monitoring	○	○
Galvanic isolation	●	●
Protection class (according to IEC 62103) <sup>3</sup> / electric arc resistance (according to IEC 62271-202)	I / IAC AB 20 kA 1s	I / IAC AB 20 kA 1s
<b>General data</b>		
Dimensions (W / H / D)	5400 / 3605 / 3000 mm (212.6 / 141.9 / 118.1 inch)	
Weight	33245 kg / 73293 lb	33725 kg / 74351 lb
Operating temperature range	-20 °C ... +40 °C / -4 °F ... +104 °F	-20 °C ... +40 °C / -4 °F ... +104 °F
Noise emission	< 65 dB(A)	
Max. self-consumption (operation) / self-consumption (night)	3000 W <sup>3</sup> / < 180 W + 1100 W <sup>6</sup>	3000 W <sup>3</sup> / < 180 W + 1350 W <sup>6</sup>
External auxiliary supply voltage / external back-up fuse for auxiliary power supply	230 / 400 V (3/N/PE) / B 32 A, 3-pin	
Cooling principle (inverter / transformer)	Forced cooling / natural convection	
Degree of protection (according to IEC 60529) <sup>7</sup>	IP23D	IP23D
Application	In unprotected outdoor environments	In unprotected outdoor environments
Use in a chemically aggressive environment	○	○
Max. permissible value for relative humidity (non-condensing)	15 % ... 95 %	15 % ... 95 %
Max. operating altitude above MSL	1000 m	1000 m
Fresh-air consumption (inverter)	6000 m <sup>3</sup> /h	6000 m <sup>3</sup> /h
<b>Features</b>		
DC connection	Ring terminal lug	Ring terminal lug
AC connection, MV side	External taper angle plug	External taper angle plug
Display <sup>3</sup>	HMI touchscreen	HMI touchscreen
Communication protocols / Sunny String-Monitor	Ethernet, Modbus/RS485/none (Optiprotect)	
SC-COM/Communit	● / ○	● / ○
Transformer for auxiliary power supply	○	○
Medium-voltage transformer with amorphous core	○	○
Medium-voltage switchgear	○	○
Color enclosure / door / base / roof	RAL 7035 / 7024 / 7024 / 7024	
Certificates and approvals (more available on request)	EN 61000-6-2, EN 61000-6-4, IEC 62271-202, EMC compliant, CE compliant, Arrêté du 23/04/08, R.D. 1663 / 2000, R.D. 661 / 2007, BDEW-MSRL / FGW / TR8 <sup>8</sup>	
● Standard feature ○ Optional feature – Not available		
Type designation	SC 1000MV-20	SC 1250MV-20

- <sup>1</sup> Start-up at DC voltages < 1000 V  
<sup>2</sup> At 1.05 V<sub>AC, nom</sub> and cos φ = 1  
<sup>3</sup> Information based on inverter  
<sup>4</sup> Efficiency measured without auxiliary power supply  
<sup>5</sup> Efficiency with amorphous medium-voltage transformer  
<sup>6</sup> Separated according to the inverter's load and open-circuit losses of the transformer  
<sup>7</sup> Degree of protection based on station building; the inverters include additional protective features  
<sup>8</sup> With complete dynamic grid support

**Please note:** In certain countries the substations may differ from the concept shown in the images.

Technical data	Sunny Central 1600MV	
<b>Input (DC)</b>		
Max. DC power (@ cos φ = 1)	1796 kW	
Max. input voltage <sup>1</sup>	1000 V / 1100 V optional	
MPP voltage range (@ 25 °C / @ 40 °C at 50 Hz) <sup>2</sup>	641 V – 820 V / 583 V – 820 V	
Rated input voltage	620 V	
Max. input current	2800 A	
Min. input voltage / V <sub>MPP_min</sub> at I <sub>MPP</sub> < I <sub>DC_max</sub>	568 V / 570 V	
Number of independent MPP inputs	2	
Number of DC inputs	18 inputs equipped with fuses	
<b>Output (AC)</b>		
Rated power (@ 25 °C) / nominal AC power (@ 40 °C)	1760 kVA / 1600 kVA	
Nominal AC voltage / range	20000 V / 18000 V – 22000 V	
AC power frequency / range	50 Hz / 47 Hz ... 53 Hz	
Rated power frequency / rated grid voltage	50 Hz / 20000 V	
Max. output current	50.8 A	
Max. total harmonic factor	< 3 %	
Power factor at rated power / displacement power factor adjustable <sup>3</sup>	1 / 0.9 overexcited ... 0.9 underexcited	
Feed-in phases / connection phases	3 / 3	
<b>Efficiency<sup>4</sup></b>		
Max. efficiency	98 % (98.2 %) <sup>5</sup>	
European weighted efficiency / CEC efficiency	97.6 % (97.8 %) <sup>5</sup>	
<b>Protective devices</b>		
DC disconnect device	Motor-driven DC switch-disconnector	
AC disconnect device	Optionally (switch-disconnector with HH fuses)	
DC overvoltage protection / AC overvoltage protection on the LV side	Surge arrester type I / surge arrester type II	
Grid monitoring / plant monitoring	● / Optionally (via Sunny Portal)	
Ground-fault monitoring / remote-controlled ground-fault monitoring	○ / ○	
Insulation monitoring	○	
Galvanic isolation	●	
Protection class (according to IEC 62103) <sup>3</sup> / electric arc resistance (according to IEC 62271-202)	I / IAC AB 20 kA 1s	
<b>General data</b>		
Dimensions (W / H / D)	5800 / 3605 / 3000 mm (228.3 / 141.9 / 118.1 inch)	
Weight	37185 kg / 81979 lb	
Operating temperature range	-20 °C ... +40 °C / -4 °F ... +104 °F	
Noise emission	< 65 dB(A)	
Max. self-consumption (operation) / self-consumption (night)	3000 W <sup>3</sup> / < 180 W + 1700 W <sup>6</sup>	
External auxiliary supply voltage / external back-up fuse for auxiliary power supply	230 / 400 V (3/N/PE) / B 32 A, 3-pin	
Cooling principle (inverter / transformer)	Forced cooling / natural convection	
Degree of protection (according to IEC 60529) <sup>7</sup>	IP23D	
Application	In unprotected outdoor environments	
Use in a chemically aggressive environment	○	
Max. permissible value for relative humidity (non-condensing)	15 % ... 95 %	
Max. operating altitude above MSL	1000 m	
Fresh-air consumption (inverter)	6000 m <sup>3</sup> /h	
<b>Features</b>		
DC connection	Ring terminal lug	
AC connection, MV side	External taper angle plug	
Display <sup>3</sup>	HMI touchscreen	
Communication protocols / Sunny String-Monitor	Ethernet, Modbus/RS485/none (Optiprotect)	
SC-COM/Communit	● / ○	
Transformer for auxiliary power supply	○	
Medium-voltage transformer with amorphous core	○	
Medium-voltage switchgear	○	
Color enclosure / door / base / roof	RAL 7035 / 7024 / 7024 / 7024	
Certificates and approvals (more available on request)	EN 61000-6-2, EN 61000-6-4, IEC 62271-202, EMC compliant, CE compliant, BDEW-MSRL / FGW / TR8 <sup>8</sup> , Arrêté du 23/04/08, R.D. 1663 / 2000, R.D. 661 / 2007	
● Standard feature ○ Optional feature – Not available		
Type designation	SC 1600MV-20	





**Powerful**

- Peak output of up to 880 kVA
- Turnkey solution for direct connection to the medium-voltage grid

**High yields plus reliability**

- Max. yields thanks to an optimized AC power path
- Comprehensive grid management functions including complete dynamic grid support (BDEW compliant)

**Communicative**

- High-performance industrial PC with a range of integrated interfaces
- Open communication interfaces, for example, Modbus, OPC

**Flexible**

- Medium-voltage switchgear systems for flexible design of large PV farms
- Amorphous transformer for minimal open-circuit losses
- Use in a chemically aggressive environment



**SUNNY CENTRAL for direct medium-voltage feed-in  
500MV / 630MV / 800MV**

High-performance medium-voltage station in the power plant class

For even more power per surface area: up to two high-performance Sunny Central HE-20 are part of a medium-voltage station (MV) that feeds directly into a shared medium-voltage transformer. A peak efficiency of more than 98 percent is achieved using an amorphous transformer. The station also requires even less maintenance, in addition to integrating high-performance communications components. Moreover, the new MV station offers extensive grid management functions and fulfills all of the requirements of the medium-voltage directive.

## OPTIONS

### Amorphous transformer

A transformer with amorphous core reduces open-circuit losses by approximately 70 percent compared to a transformer with an iron core (loss class C).

For example, open-circuit losses of a 1600 kVA transformer with an iron core: 1700 W open-circuit losses with amorphous core: 510 W. Energy gain in 20 years: around 200,000 kWh.

### Medium-voltage switchgear

Using medium-voltage switchgear, several SUNNY CENTRAL MV stations can be connected in a string or a ring. This allows modular construction of large PV farms.

### Transformer for auxiliary power supply

An auxiliary power supply transformer (6 kVA) allows the supply of the SUNNY CENTRAL MV Station from the medium-voltage grid.

### Use in a chemically aggressive environment

If desired, the SUNNY CENTRAL MV Station can be optimized for use in a chemically aggressive environment, such as for seaside installation.

### Communit

The Communit communication distributor is designed to house and wire together all communication components used in large-scale PV plants with SUNNY CENTRAL.

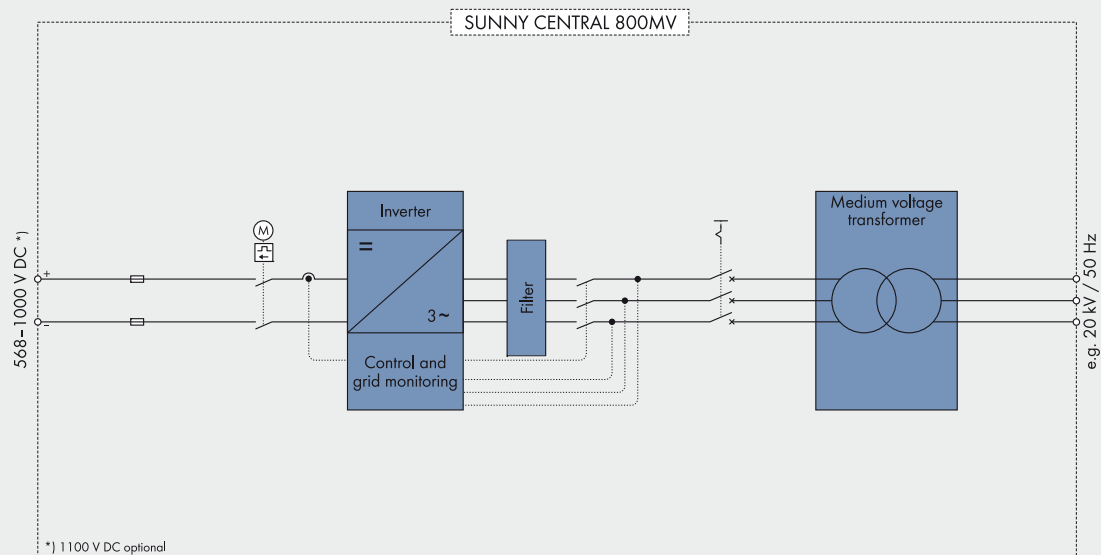
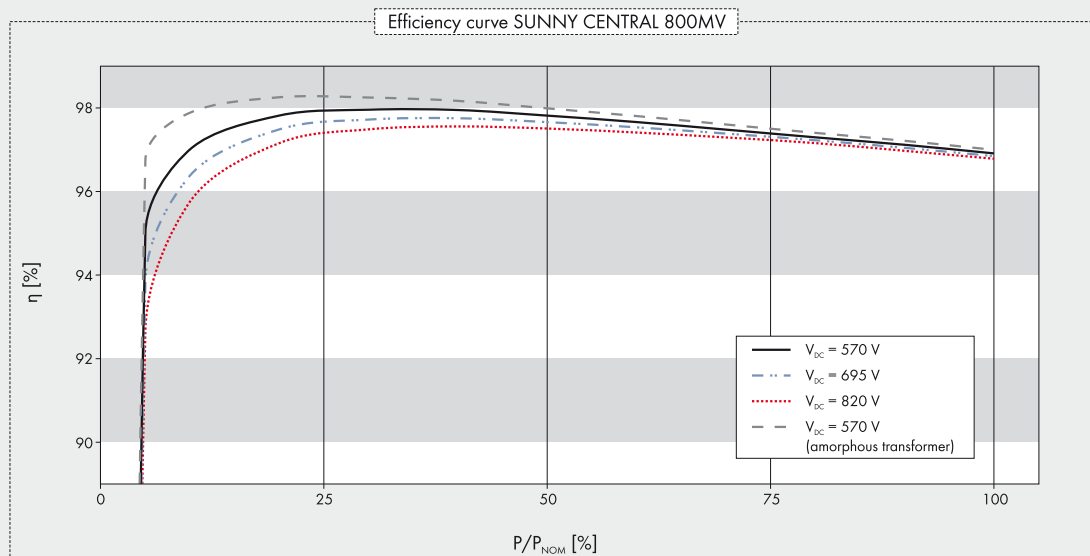

# SUNNY CENTRAL for direct medium-voltage feed-in 500MV / 630MV / 800MV

Technical data	Sunny Central 500MV	Sunny Central 630MV
<b>Input (DC)</b>		
Max. DC power (@ $\cos \varphi = 1$ )	560 kW	713 kW
Max. input voltage <sup>1</sup>	1000 V / 1100 V optional	1000 V / 1100 V optional
MPP voltage range (@ 25 °C / @ 40 °C at 50 Hz) <sup>2</sup>	449 V – 820 V / 430 V – 820 V	529 V – 820 V / 500 V – 820 V
Rated input voltage	480 V	550 V
Max. input current	1250 A	1350 A
Min. input voltage / $V_{MPP\_min}$ at $I_{MPP} < I_{DCmax}$	429 V / 430 V	498 V / 500 V
Number of independent MPP inputs	1	1
Number of DC inputs	9 inputs equipped with fuses	9 inputs equipped with fuses
<b>Output (AC)</b>		
Rated power (@ 25 °C) / nominal AC power (@ 40 °C)	550 kVA / 500 kVA	700 kVA / 630 kVA
Nominal AC voltage / range	20000 V / 18000 V – 22000 V	20000 V / 18000 V – 22000 V
AC power frequency / range	50 Hz / 47 Hz ... 53 Hz	50 Hz / 47 Hz ... 53 Hz
Rated power frequency / rated grid voltage	50 Hz / 20000 V	50 Hz / 20000 V
Max. output current	15.9 A	20.2 A
Max. total harmonic factor	< 3 %	< 3 %
Power factor at rated power / displacement power factor adjustable <sup>3</sup>	1 / 0.9 overexcited ... 0.9 underexcited	
Feed-in phases / connection phases	3 / 3	3 / 3
<b>Efficiency<sup>4</sup></b>		
Max. efficiency	97.8 % (98.1 %)⁵	97.9 % (98.2 %)⁵
European weighted efficiency / CEC efficiency	97.4 % (97.8 %)⁵	97.5 % (97.8 %)⁵
<b>Protective devices</b>		
DC disconnect device	Motor-driven DC switch-disconnector	
AC disconnect device	Optionally (switch-disconnector with HH fuses)	
DC overvoltage protection / AC overvoltage protection on the LV side	Surge arrester type I / surge arrester type II	
Grid monitoring / plant monitoring	● / Optionally (via Sunny Portal)	● / Optionally (via Sunny Portal)
Ground-fault monitoring / remote-controlled ground-fault monitoring	○ / ○	○ / ○
Insulation monitoring	○	○
Galvanic isolation	●	●
Protection class (according to IEC 62103) <sup>3</sup> / electric arc resistance (according to IEC 62271-202)	I / IAC AB 20 kA 1s	I / IAC AB 20 kA 1s
<b>General data</b>		
Dimensions (W / H / D)	5100 / 3605 / 2600 mm (207.9 / 141.9 / 102.4 inch)	
Weight	28695 kg / 63262 lb	28955 kg / 63835 lb
Operating temperature range	-20 °C ... +40 °C / -4 °F ... +104 °F	-20 °C ... +40 °C / -4 °F ... +104 °F
Noise emission	< 65 dB(A)	
Max. self-consumption (operation) / self-consumption (night)	1500 W <sup>3</sup> / < 100 W + 720 W <sup>6</sup>	1500 W <sup>3</sup> / < 100 W + 800 W <sup>6</sup>
External auxiliary supply voltage / external back-up fuse for auxiliary power supply	230 / 400 V (3/N/PE) / B 32 A, 3-pin	
Cooling principle (inverter / transformer)	Forced cooling / natural convection	
Degree of protection (according to IEC 60529) <sup>7</sup>	IP23D	IP23D
Application	In unprotected outdoor environments	In unprotected outdoor environments
Use in a chemically aggressive environment	○	○
Max. permissible value for relative humidity (non-condensing)	15 % ... 95 %	15 % ... 95 %
Max. operating altitude above MSL	1000 m	1000 m
Fresh-air consumption (inverter)	3000 m³/h	3000 m³/h
<b>Features</b>		
DC connection	Ring terminal lug	Ring terminal lug
AC connection, MV side	External taper angle plug	External taper angle plug
Display <sup>3</sup>	HMI touchscreen	HMI touchscreen
Communication protocols / Sunny String-Monitor	Ethernet, Modbus/RS485/none (Optiprotect)	
SC-COM/Communit	● / ○	● / ○
Transformer for auxiliary power supply	○	○
Medium-voltage transformer with amorphous core	○	○
Medium-voltage switchgear	○	○
Color enclosure / door / base / roof	RAL 7035 / 7024 / 7024 / 7024	
Certificates and approvals (more available on request)	EN 61000-6-2, EN 61000-6-4, IEC 62271-202, EMC compliant, CE compliant, Arrêté du 23/04/08, R.D. 1663 / 2000, R.D. 661 / 2007, BDEW-MSRL / FGW / TR8 <sup>8</sup>	
● Standard feature ○ Optional feature – Not available		
Type designation	SC 500MV-20	SC 630MV-20

<sup>1</sup> Start-up at DC voltages < 1000 V

<sup>2</sup> At 1.05 V<sub>AC, nom</sub> and cos φ = 1

<sup>3</sup> Information based on inverter

<sup>4</sup> Efficiency measured without auxiliary power supply

<sup>5</sup> Efficiency with amorphous medium-voltage transformer

<sup>6</sup> Separated according to consumption of the inverter and open-circuit losses of the transformer

<sup>7</sup> Degree of protection based on station building; the inverters include additional protective features

<sup>8</sup> With complete dynamic grid support

**Please note:** In certain countries the substations may differ from the concept shown in the images.

Technical data	Sunny Central 800MV	
<b>Input (DC)</b>		
Max. DC power (@ cos φ = 1)	898 kW	
Max. input voltage <sup>1</sup>	1000 V / 1100 V optional	
MPP voltage range (@ 25 °C / @ 40 °C at 50 Hz) <sup>2</sup>	641 V – 820 V / 583 V – 820 V	
Rated input voltage	620 V	
Max. input current	1400 A	
Min. input voltage / V <sub>MPP_min</sub> at I <sub>MPP</sub> < I <sub>DC_max</sub>	568 V / 570 V	
Number of independent MPP inputs	1	
Number of DC inputs	9 inputs equipped with fuses	
<b>Output (AC)</b>		
Rated power (@ 25 °C) / nominal AC power (@ 40 °C)	880 kVA / 800 kVA	
Nominal AC voltage / range	20000 V / 18000 V – 22000 V	
AC power frequency / range	50 Hz / 47 Hz ... 53 Hz	
Rated power frequency / rated grid voltage	50 Hz / 20000 V	
Max. output current	25.4 A	
Max. total harmonic factor	< 3 %	
Power factor at rated power / displacement power factor adjustable <sup>3</sup>	1 / 0.9 overexcited ... 0.9 underexcited	
Feed-in phases / connection phases	3 / 3	
<b>Efficiency<sup>4</sup></b>		
Max. efficiency	97.9 % (98.2 %) <sup>5</sup>	
European weighted efficiency / CEC efficiency	97.5 % (97.8 %) <sup>5</sup>	
<b>Protective devices</b>		
DC disconnect device	Motor-driven DC switch-disconnector	
AC disconnect device	Optionally (switch-disconnector with HH fuses)	
DC overvoltage protection / AC overvoltage protection on the LV side	Surge arrester type I / surge arrester type II	
Grid monitoring / plant monitoring	● / Optionally (via Sunny Portal)	
Ground-fault monitoring / remote-controlled ground-fault monitoring	○ / ○	
Insulation monitoring	○	
Galvanic isolation	●	
Protection class (according to IEC 62103) <sup>3</sup> / electric arc resistance (according to IEC 62271-202)	I / IAC AB 20 kA 1s	
<b>General data</b>		
Dimensions (W / H / D)	5100 / 3605 / 2600 mm (207.9 / 141.9 / 102.4 inch)	
Weight	29175 kg / 64320 lb	
Operating temperature range	-20 °C ... +40 °C / -4 °F ... +104 °F	
Noise emission	< 65 dB(A)	
Max. self-consumption (operation) / self-consumption (night)	1500 W <sup>3</sup> / < 100 W + 930 W <sup>6</sup>	
External auxiliary supply voltage / external back-up fuse for auxiliary power supply	230 / 400 V (3/N/PE) / B 32 A, 3-pin	
Cooling principle (inverter / transformer)	Forced cooling / natural convection	
Degree of protection (according to IEC 60529) <sup>7</sup>	IP23D	
Application	In unprotected outdoor environments	
Use in a chemically aggressive environment	○	
Max. permissible value for relative humidity (non-condensing)	15 % ... 95 %	
Max. operating altitude above MSL	1000 m	
Fresh-air consumption (inverter)	3000 m <sup>3</sup> /h	
<b>Features</b>		
DC connection	Ring terminal lug	
AC connection, MV side	External taper angle plug	
Display <sup>3</sup>	HMI touchscreen	
Communication protocols / Sunny String-Monitor	Ethernet, Modbus/RS485/none (Optiprotect)	
SC-COM/Communit	● / ○	
Transformer for auxiliary power supply	○	
Medium-voltage transformer with amorphous core	○	
Medium-voltage switchgear	○	
Color enclosure / door / base / roof	RAL 7035 / 7024 / 7024 / 7024	
Certificates and approvals (more available on request)	EN 61000-6-2, EN 61000-6-4, IEC 62271-202, EMC compliant, CE compliant, Arrêté du 23/04/08, R.D. 1663 / 2000, R.D. 661 / 2007, BDEW-MSRL / FGW / TR8 <sup>8</sup>	
● Standard feature ○ Optional feature – Not available		
Type designation	SC 800MV-20	



### Reliable

- Excellent specific price
- Full nominal power up to 50 °C
- 10 % additional power in continuous operation at ambient temperatures up to 25 °C
- Efficiency of more than 98 percent

### Flexible

- Integrated DC main distribution for direct connection of the String-Monitors
- Flexible plant design due to input voltage up to 1000 V
- Connection of up to two external DC main distributors for diverse system configuration

### Secure

- Comprehensive grid management functions
- Perfect monitoring of all PV strings in the field



## SUNNY CENTRAL 400HE / 500HE / 630HE

Proven high performance

High flexibility and minimal system costs with even more power: the proven High Efficiency series for direct connection to the medium-voltage transformer provides you with reliable advantages that pay off, thanks to its intelligent power management. This means that maximum power in continuous operation has been increased by ten percent compared to the nominal power for as long as the ambient temperature does not exceed 25 °C. At the same time, the devices offer comprehensive grid management functions as well as immediate reconnection after a grid voltage drop.



Efficiency curve SUNNY CENTRAL 630HE

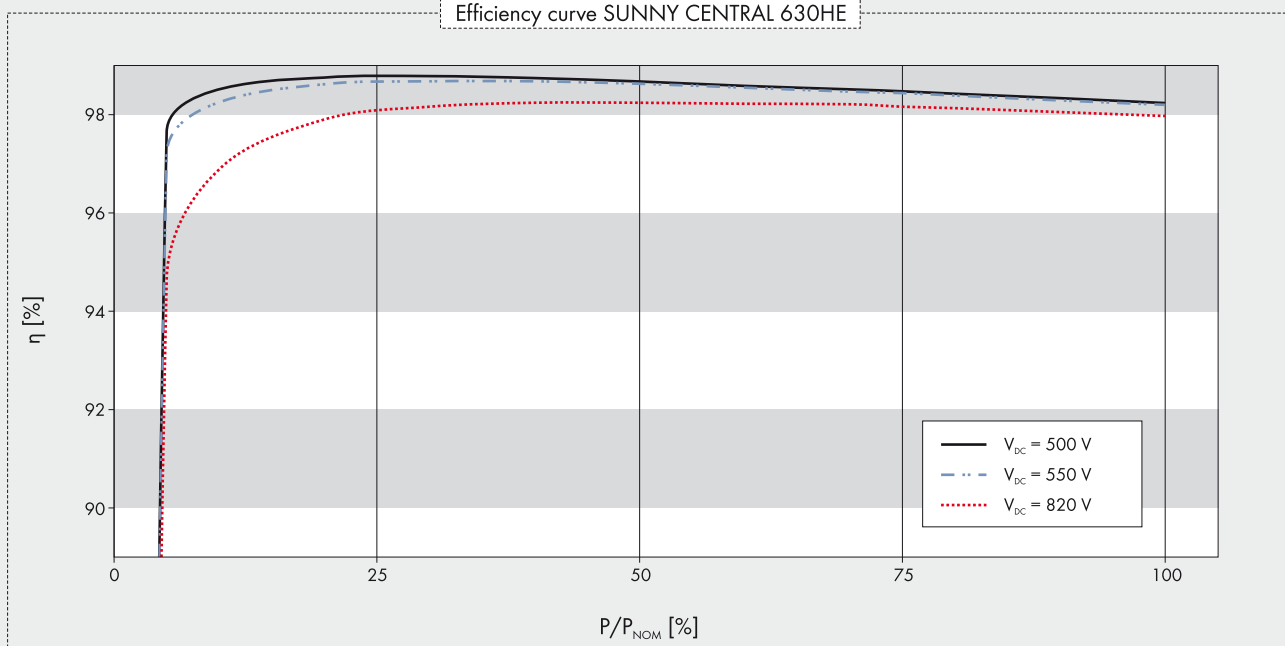

SUNNY CENTRAL 400HE / 500HE / 630HE

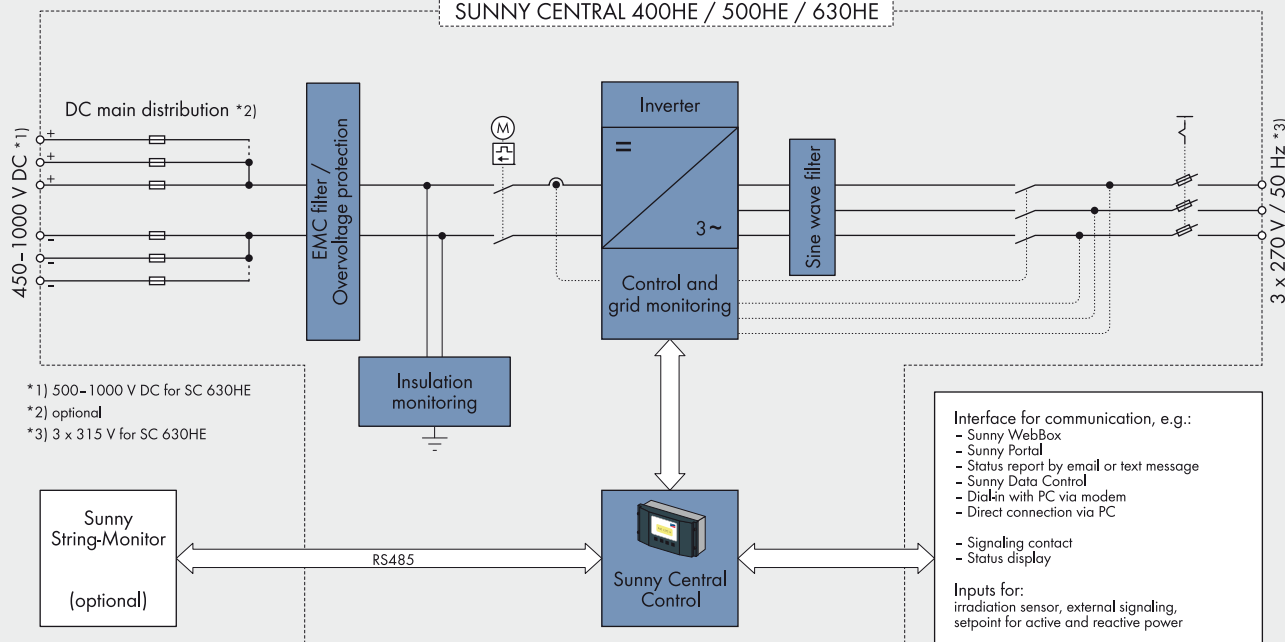

\*1) 500-1000 V DC for SC 630HE  
 \*2) optional  
 \*3) 3 x 315 V for SC 630HE

# SUNNY CENTRAL 400HE / 500HE / 630HE

Technical data	Sunny Central 400HE	Sunny Central 500HE
<b>Input (DC)</b>		
Max. DC power (@ cos φ = 1)	448 kW	560 kW
Max. input voltage	1000 V	1000 V
MPP voltage range (@ 25 °C / @ 50 °C at 50 Hz) <sup>1</sup>	450 V – 820 V / 450 V – 820 V	450 V – 820 V / 450 V – 820 V
MPP voltage range (@ 25 °C at 60 Hz) <sup>1</sup>	450 V – 820 V	450 V – 820 V
Rated input voltage	500 V	500 V
Min. input voltage	450 V	450 V
Max. input current	993 A	1242 A
Number of independent MPP inputs	1	1
Number of DC inputs	(8 + 8) + 2 DCHV	(8 + 8) + 2 DCHV
<b>Output (AC)</b>		
Rated power (@ 25 °C) / nominal AC power (@ 50 °C)	440 kVA / 400 kVA	550 kVA / 500 kVA
Nominal AC voltage / range	270 V / 243 V – 297 V	270 V / 243 V – 297 V
AC power frequency / range	50 Hz, 60 Hz / 47 Hz ... 63 Hz	50 Hz, 60 Hz / 47 Hz ... 63 Hz
Rated power frequency / rated grid voltage	50 Hz / 270 V	50 Hz / 270 V
Max. output current	941 A	1176 A
Max. total harmonic factor	< 3 %	< 3 %
Power factor at rated power / displacement power factor adjustable	1 / 0.9 overexcited ... 0.9 underexcited	1 / 0.9 overexcited ... 0.9 underexcited
Feed-in phases, connection phases	3 / 3	3 / 3
<b>Efficiency<sup>2</sup></b>		
Max. efficiency / European weighted efficiency / CEC efficiency	98.6 % / 98.4 % / 98.5 %	98.6 % / 98.4 % / 98.5 %
<b>Protective devices</b>		
DC disconnect device	Motor-driven DC switch-disconnector	
AC disconnect device	AC fuse switch-disconnector	
DC overvoltage protection, AC overvoltage protection	Type II surge arrester / type I surge arrester	
Grid monitoring	●	●
Ground-fault monitoring / remote-controlled ground-fault monitoring	● / ○	● / ○
Insulation monitoring	●	●
Protection class (according to IEC 62103)	I	I
<b>General data</b>		
Dimensions (W / H / D)	2800 / 2120 / 850 mm (110.3 / 83.5 / 33.5 inches)	
Weight	1900 kg / 4189 lb	1900 kg / 4189 lb
Operating temperature range	-20 °C ... +50 °C / -4 °F ... +122 °F	-20 °C ... +50 °C / -4 °F ... +122 °F
Noise emission <sup>3</sup>	56.27 db(A)	56.95 db(A)
Max. self-consumption (operation) / self-consumption (night)	1500 W <sup>4</sup> / < 100 W	1500 W <sup>4</sup> / < 100 W
External auxiliary supply voltage	3 x 230 V, 50 / 60 Hz	3 x 230 V, 50 / 60 Hz
Cooling concept	Forced cooling	
Degree of protection: electronics / connection area (according to IEC 60529)	IP20 / IP20	
Application	Not air-conditioned indoors	Not air-conditioned indoors
Use in chemically active environment	○	○
Max. permissible value for relative humidity (non-condensing)	15 % ... 95 %	15 % ... 95 %
Max. operating altitude above MSL	1000 m	1000 m
Fresh-air consumption	6200 m <sup>3</sup> /h	6200 m <sup>3</sup> /h
<b>Features</b>		
DC connection	Ring terminal lug / cage clamp	Ring terminal lug / cage clamp
AC connection	Ring terminal lug	Ring terminal lug
Display	LC text display	LC text display
Communication protocols / Sunny String-Monitor	Ethernet, Modbus / RS485	Ethernet, Modbus / RS485
Analog inputs / overvoltage protection for analog inputs	2 x Ain <sup>5</sup> / ○	2 x Ain <sup>5</sup> / ○
Transformer for auxiliary power supply	○	○
Plant monitoring	Optionally (via Sunny Portal)	Optionally (via Sunny Portal)
Warranty: 5 / 10 / 15 / 20 / 25 years	● / ○ / ○ / ○ / –	● / ○ / ○ / ○ / –
Certificates and approvals (more available on request)	EN 61000-6-2, EN 61000-6-4, EMC compliant, CE compliant, Arrêté du 23/04/08, R.D. 1663 / 2000, R.D. 661 / 2007, Golden Sun CGC / GF 001:2009, BDEW-MSRL / FGW / TR8 <sup>6</sup>	
● Standard feature   ○ Optional feature   – Not available		
Type designation	SC 400HE-11	SC 500HE-11

HE: High Efficiency, inverter without galvanic isolation for connection to a medium-voltage transformer (taking into account the SMA specification for the transformer)

<sup>1</sup> At 1.05  $V_{AC, nom}$  and  $\cos \varphi = 1$

<sup>2</sup> Efficiency measured without auxiliary power supply at  $V_{DC} = 500$  V

<sup>3</sup> Sound pressure level at a distance of 10 m

<sup>4</sup> Max. power in a phase < 1400 W (asymmetrical consumption)

<sup>5</sup> Each with 1 x irradiation sensor and 1 x pyranometer

<sup>6</sup> With limited dynamic grid support

Other features: heating, emergency switching-off

Technical data	Sunny Central 630HE	
<b>Input (DC)</b>		
Max. DC power (@ $\cos \varphi = 1$ )	713 kW	
Max. input voltage	1000 V	
MPP voltage range (@ 25 °C / @ 50 °C at 50 Hz) <sup>1</sup>	500 V – 820 V / 500 V – 820 V	
MPP voltage range (@ 25 °C at 60 Hz) <sup>1</sup>	510 V – 820 V	
Rated input voltage	550 V	
Min. input voltage	500 V	
Max. input current	1422 A	
Number of independent MPP inputs	1	
Number of DC inputs	(8 + 8) + 2 DCHV	
<b>Output (AC)</b>		
Rated power (@ 25 °C) / nominal AC power (@ 50 °C)	700 kVA / 630 kVA	
Nominal AC voltage / range	315 V / 284 V – 346 V	
AC power frequency / range	50 Hz, 60 Hz / 47 Hz ... 63 Hz	
Rated power frequency / rated grid voltage	50 Hz / 315 V	
Max. output current	1283 A	
Max. total harmonic factor	< 3 %	
Power factor at rated power / displacement power factor adjustable	1 / 0.9 overexcited ... 0.9 underexcited	
Feed-in phases, connection phases	3 / 3	
<b>Efficiency<sup>2</sup></b>		
Max. efficiency / European weighted efficiency / CEC efficiency	98.6 % / 98.4 % / 98.5 %	
<b>Protective devices</b>		
DC disconnect device	Motor-driven DC switch-disconnector	
AC disconnect device	AC fuse switch-disconnector	
DC overvoltage protection, AC overvoltage protection	Type II surge arrester / type I surge arrester	
Grid monitoring	●	
Ground-fault monitoring / remote-controlled ground-fault monitoring	● / ○	
Insulation monitoring	●	
Protection class (according to IEC 62103)	I	
<b>General data</b>		
Dimensions (W / H / D)	2800 / 2120 / 850 mm (110.3 / 83.5 / 33.5 inches)	
Weight	1900 kg / 4189 lb	
Operating temperature range	-20 °C ... +50 °C / -4 °F ... +122 °F	
Noise emission <sup>3</sup>	64.2 db(A)	
Max. self-consumption (operation) / self-consumption (night)	1500 W <sup>4</sup> / < 100 W	
External auxiliary supply voltage	3 x 230 V, 50 / 60 Hz	
Cooling concept	Forced cooling	
Degree of protection: electronics / connection area (according to IEC 60529)	IP20 / IP20	
Application	Not air-conditioned indoors	
Use in chemically active environment	○	
Max. permissible value for relative humidity (non-condensing)	15 % ... 95 %	
Max. operating altitude above MSL	1000 m	
Fresh-air consumption	6200 m <sup>3</sup> /h	
<b>Features</b>		
DC connection	Ring terminal lug / cage clamp	
AC connection	Ring terminal lug	
Display	LC text display	
Communication protocols / Sunny String-Monitor	Ethernet, Modbus / RS485	
Analog inputs / overvoltage protection for analog inputs	2 x Ain <sup>5</sup> / ○	
Transformer for auxiliary power supply	○	
Plant monitoring	Optionally (via Sunny Portal)	
Warranty: 5 / 10 / 15 / 20 / 25 years	● / ○ / ○ / ○ / –	
Certificates and approvals (more available on request)	EN 61000-6-2, EN 61000-6-4, EMC compliant, CE compliant, BDEW-MSRL / FGW / TR8 <sup>6</sup> , Arrêté du 23/04/08 <sup>3</sup> , R.D. 1663 / 2000, R.D. 661 / 2007, Golden Sun CGC / GF 001:2009	
● Standard feature   ○ Optional feature   – Not available		
Type designation	SC 630HE-11	



#### Efficient

- Greater efficiency without low-voltage transformers due to direct connection to the medium-voltage grid

#### Turnkey solution

- Complete with medium-voltage transformer and concrete station for outdoor installation

#### Optional

- Medium-voltage switchgear systems for flexible design of large PV farms
- AC transfer station with measurement
- Medium-voltage transformers for other line voltages (deviating from 20 kV)
- Amorphous transformer for minimal open-circuit losses



## SUNNY CENTRAL for direct medium-voltage feed-in 800MV / 1000MV / 1250MV

High-performance medium-voltage station

For even more power: Two powerful SMA Sunny Central HE inverters are components of a medium-voltage station (MV) that feeds directly into a shared medium-voltage transformer. In this way, for example, two Sunny Central 630HE inverters are combined into a powerful Sunny Central 1250MV station. The advantage: By removing the need for low-voltage transformers and using the amorphous transformer, the efficiency is increased and, at the same time, the inverter costs are lower. An investment that also pays off in the future.

Efficiency curve SUNNY CENTRAL 1250MV

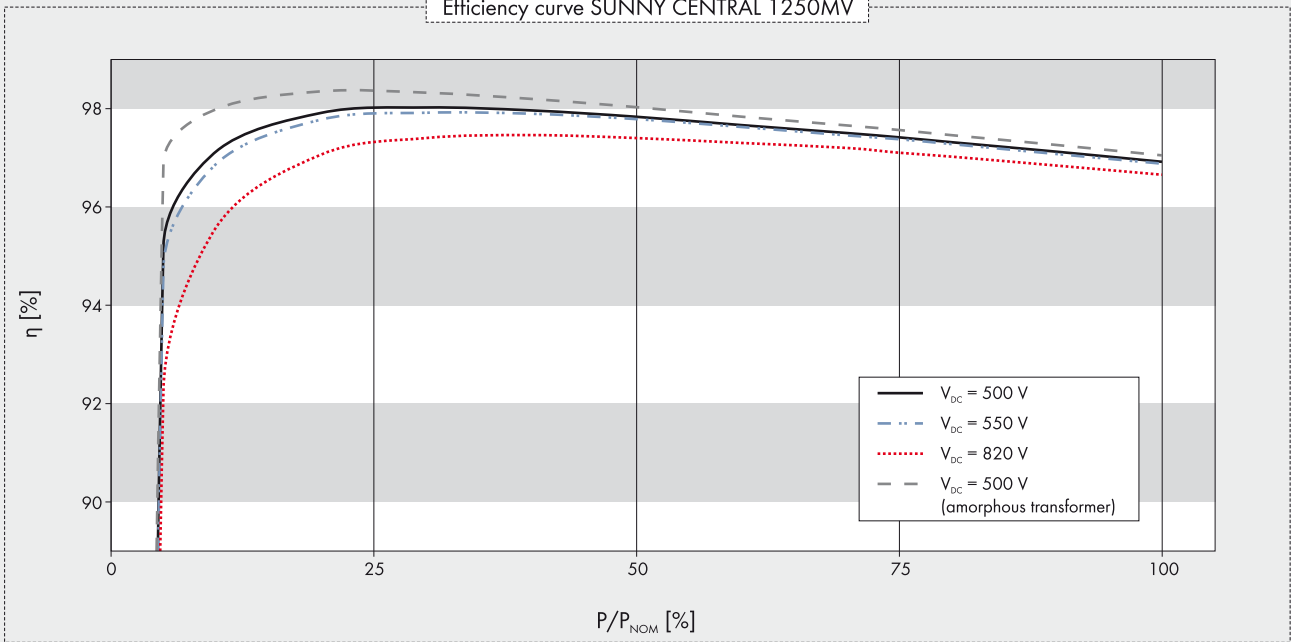

SUNNY CENTRAL 800MV / 1000MV / 1250MV

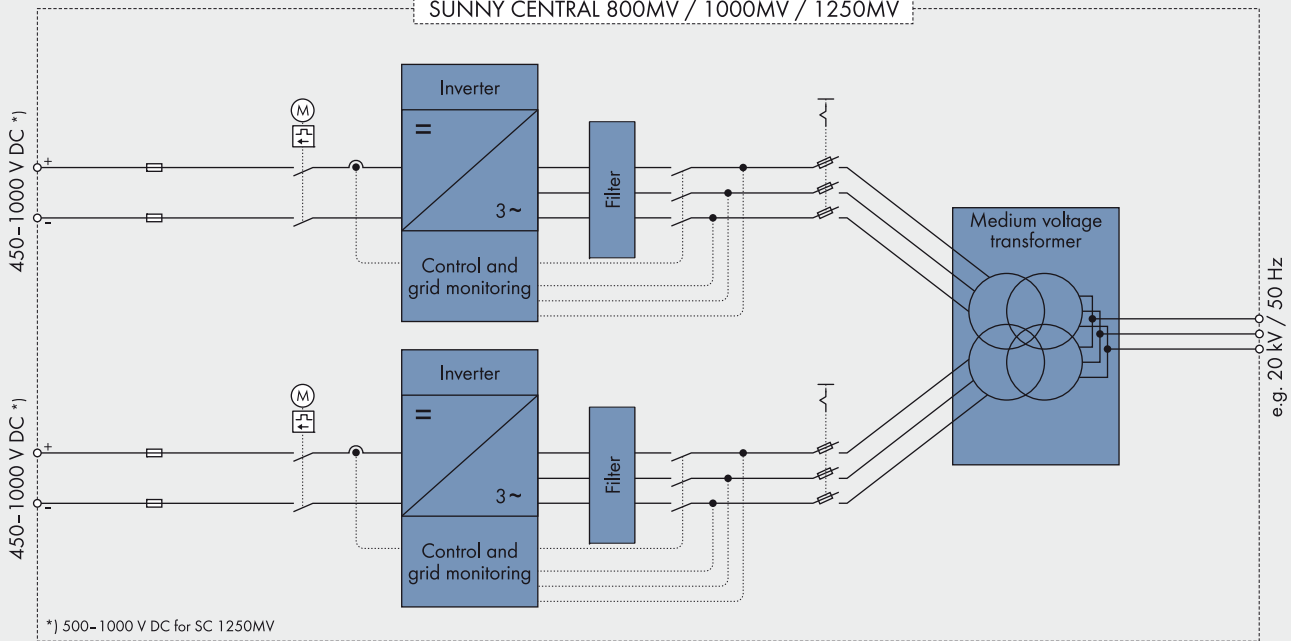



# SUNNY CENTRAL for direct medium-voltage feed-in

## 800MV / 1000MV / 1250MV

Technical data	Sunny Central 800MV	Sunny Central 1000MV
<b>Input (DC)</b>		
Max. DC power (@ cos φ = 1)	909 kW	1133 kW
Max. input voltage	1000 V	1000 V
MPP voltage range (@ 25 °C / @45 °C at 50 Hz) <sup>1</sup>	450 V – 820 V / 450 V – 820 V	450 V – 820 V / 450 V – 820 V
MPP voltage range (@ 25 °C at 60 Hz) <sup>1</sup>	450 V – 820 V	450 V – 820 V
Rated input voltage	500 V	500 V
Max. input current	1986 A	2484 A
Min. input voltage	450 V	450 V
Number of independent MPP inputs	2	2
Number of DC inputs	(16 + 16) + 4 DCHV	(16 + 16) + 4 DCHV
<b>Output (AC)</b>		
Rated power (@ 25 °C) / nominal AC power (@ 45 °C)	880 kVA / 800 kVA	1100 kVA / 1000 kVA
Nominal AC voltage / range	20000 V / 18000 V – 22000 V	20000 V / 18000 V – 22000 V
AC power frequency / range	50 Hz, 60 Hz / 47 Hz ... 63 Hz	50 Hz, 60 Hz / 47 Hz ... 63 Hz
Rated power frequency / rated grid voltage	50 Hz / 20000 V	50 Hz / 20000 V
Max. output current	25.4 A	31.8 A
Max. total harmonic factor	< 3 %	< 3 %
Power factor at rated power / displacement power factor adjustable	1 / 0.9 overexcited ... 0.9 underexcited	1 / 0.9 overexcited ... 0.9 underexcited
Feed-in phases / connection phases	3 / 3	3 / 3
<b>Efficiency<sup>2</sup></b>		
Max. efficiency / European weighted efficiency	97.9 % / 97.5 %	97.9 % / 97.5 %
<b>Protective devices</b>		
DC disconnect device	Motor-driven DC switch-disconnector	
AC disconnect device	Optionally (switch-disconnector with HH fuses)	
DC overvoltage protection / AC overvoltage protection on the LV side	Type II surge arrester / type I surge arrester	
Grid monitoring	●	●
Ground-fault monitoring / remote-controlled ground-fault monitoring	● / ○	● / ○
Insulation monitoring	●	●
Galvanic isolation	●	●
Protection class (according to IEC 62103) <sup>3</sup>	I	I
<b>General data</b>		
Dimensions (W / H / D)	5400 / 3620 / 3000 mm (212.6 / 142.5 / 118.1 inch)	
Weight	35000 kg / 77162 lb	35000 kg / 77162 lb
Operating temperature range	-20 °C ... +45 °C / -4 °F ... +113 °F	
Max. self-consumption (operation) / self-consumption (night)	3000 W <sup>7</sup> / < 180 W + 1100 W <sup>5</sup>	
External auxiliary supply voltage / external back-up fuse for auxiliary power supply	3 x 230 V, 50 / 60 Hz / B 32 A, 3-pin	
Cooling principle (inverter / transformer)	Forced cooling / natural convection	
Degree of protection: electronics / connection area (according to IEC 60529)	IP20 / IP54	IP20 / IP54
Application	In unprotected outdoor environments	In unprotected outdoor environments
Max. permissible value for relative humidity (non-condensing)	15 % ... 95 %	15 % ... 95 %
Max. operating altitude above MSL	1000 m	1000 m
Fresh-air consumption	12400 m <sup>3</sup> /h	12400 m <sup>3</sup> /h
<b>Features</b>		
DC connection	Ring terminal lug / cage clamp	Ring terminal lug / cage clamp
AC connection, MV side	External taper angle plug	External taper angle plug
Display	LC text display	LC text display
Communication / protocols	Ethernet, Modbus	Ethernet, Modbus
Sunny String-Monitor	RS485	RS485
Analog inputs / overvoltage protection for analog inputs	4 x Ain <sup>4</sup> / ○	4 x Ain <sup>4</sup> / ○
Transformer for auxiliary power supply	○	○
Medium-voltage transformer with amorphous core	○	○
Medium-voltage switchgear	○	○
Color enclosure / door / base / roof	RAL 7035 / 7024 / 7024 / 7024	
Certificates and approvals (more available on request)	EN 61000-6-2, EN 61000-6-4, IEC 62271-202, EMC compliant, CE compliant, Arrêté du 23/04/08, R.D. 1663 / 2000, R.D. 661 / 2007, BDEW-MSRL / FGW / TR8 <sup>6</sup>	
● Standard feature ○ Optional feature – Not available		
Type designation	SC 800MV-11	SC 1000MV-11

- <sup>1</sup> At 1.05 V<sub>AC, nom</sub> and cos φ = 1  
<sup>2</sup> Efficiency measured without auxiliary power supply at V<sub>DC</sub> = 500 V  
<sup>3</sup> Information based on inverter  
<sup>4</sup> 1 x irradiation sensor and 1 x pyranometer for each inverter  
<sup>5</sup> Separated according to the inverter's load and open-circuit losses of the transformer  
<sup>6</sup> With limited dynamic grid support  
<sup>7</sup> Max. power in a phase for each inverter < 1400 W (asymmetrical consumption)

**Please note:** In certain countries the substations may differ from the concept shown in the images.

Technical data	Sunny Central 1250MV	
<b>Input (DC)</b>		
Max. DC power (@ cos φ = 1)	1448 kW	
Max. input voltage	1000 V	
MPP voltage range (@ 25 °C / @45 °C at 50 Hz) <sup>1</sup>	500 V – 820 V / 500 V – 820 V	
MPP voltage range (@ 25 °C at 60 Hz) <sup>1</sup>	510 V – 820 V	
Rated input voltage	550 V	
Max. input current	2844 A	
Min. input voltage	500 V	
Number of independent MPP inputs	2	
Number of DC inputs	(16 + 16) + 4 DCHV	
<b>Output (AC)</b>		
Rated power (@ 25 °C) / nominal AC power (@ 45 °C)	1400 kVA / 1250 kVA	
Nominal AC voltage / range	20000 V / 18000 V – 22000 V	
AC power frequency / range	50 Hz, 60 Hz / 47 Hz ... 63 Hz	
Rated power frequency / rated grid voltage	50 Hz / 20000 V	
Max. output current	40.4 A	
Max. total harmonic factor	< 3 %	
Power factor at rated power / displacement power factor adjustable	1 / 0.9 overexcited ... 0.9 underexcited	
Feed-in phases / connection phases	3 / 3	
<b>Efficiency<sup>2</sup></b>		
Max. efficiency / European weighted efficiency	98 % / 97.6 %	
<b>Protective devices</b>		
DC disconnect device	Motor-driven DC switch-disconnector	
AC disconnect device	Optionally (switch-disconnector with HH fuses)	
DC overvoltage protection / AC overvoltage protection on the LV side	Type II surge arrester / type I surge arrester	
Grid monitoring	●	
Ground-fault monitoring / remote-controlled ground-fault monitoring	● / ○	
Insulation monitoring	●	
Galvanic isolation	●	
Protection class (according to IEC 62103) <sup>3</sup>	I	
<b>General data</b>		
Dimensions (W / H / D)	5400 / 3620 / 3000 mm (212.6 / 142.5 / 118.1 inch)	
Weight	35000 kg / 77162 lb	
Operating temperature range	-20 °C ... +45 °C / -4 °F ... +113 °F	
Max. self-consumption (operation) / self-consumption (night)	3000 W <sup>7</sup> / < 180 W + 1350 W <sup>5</sup>	
External auxiliary supply voltage / external back-up fuse for auxiliary power supply	3 x 230 V, 50 / 60 Hz / B 32 A, 3-pin	
Cooling principle (inverter / transformer)	Forced cooling / natural convection	
Degree of protection: electronics / connection area (according to IEC 60529)	IP20 / IP54	
Application	In unprotected outdoor environments	
Max. permissible value for relative humidity (non-condensing)	15 % ... 95 %	
Max. operating altitude above MSL	1000 m	
Fresh-air consumption	12400 m <sup>3</sup> /h	
<b>Features</b>		
DC connection	Ring terminal lug / cage clamp	
AC connection, MV side	External taper angle plug	
Display	LC text display	
Communication / protocols	Ethernet, Modbus	
Sunny String-Monitor	RS485	
Analog inputs / overvoltage protection for analog inputs	4 x Ain <sup>4</sup> / ○	
Transformer for auxiliary power supply	○	
Medium-voltage transformer with amorphous core	○	
Medium-voltage switchgear	○	
Color enclosure / door / base / roof	RAL 7035 / 7024 / 7024 / 7024	
Certificates and approvals (more available on request)	EN 61000-6-2, EN 61000-6-4, IEC 62271-202, EMC compliant, CE compliant, Arrêté du 23/04/08, R.D. 1663 / 2000, R.D. 661 / 2007, BDEW-MSRL / FGW / TR8 <sup>6</sup>	
● Standard feature ○ Optional feature – Not available		
Type designation	SC 1250MV-11	



#### Efficient

- Greater efficiency without low-voltage transformers due to direct connection to the medium-voltage grid

#### Turnkey solution

- Complete with medium-voltage transformer and concrete substation for outdoor installation

#### Optional

- Medium-voltage switchgear systems for flexible design of large PV farms
- AC transfer station with measurement
- Medium-voltage transformers for other line voltages (deviating from 20 kV)
- Amorphous transformer for minimal open-circuit losses



## SUNNY CENTRAL for direct medium-voltage feed-in 400MV / 500MV / 630MV

The substation for safe grid management

Equipped with an SMA central inverter of the HE product series and a medium-voltage transformer, the Sunny Central MV feeds directly into the medium-voltage grid. By removing the need for low-voltage transformers and simultaneously deploying the amorphous transformer, efficiency is increased and, at the same time, inverter costs for plant operators are lowered. The Sunny Central MV is delivered as a turnkey concrete substation for outside installation.

Efficiency curve SUNNY CENTRAL 630MV

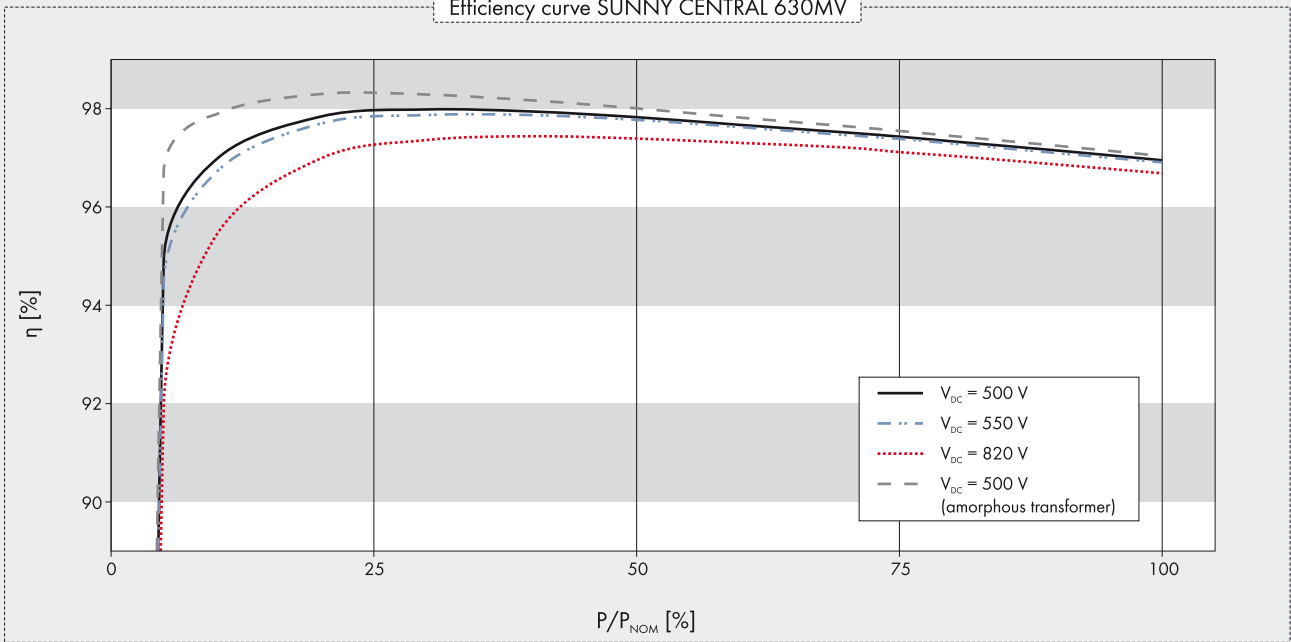

SUNNY CENTRAL 400MV / 500MV / 630MV

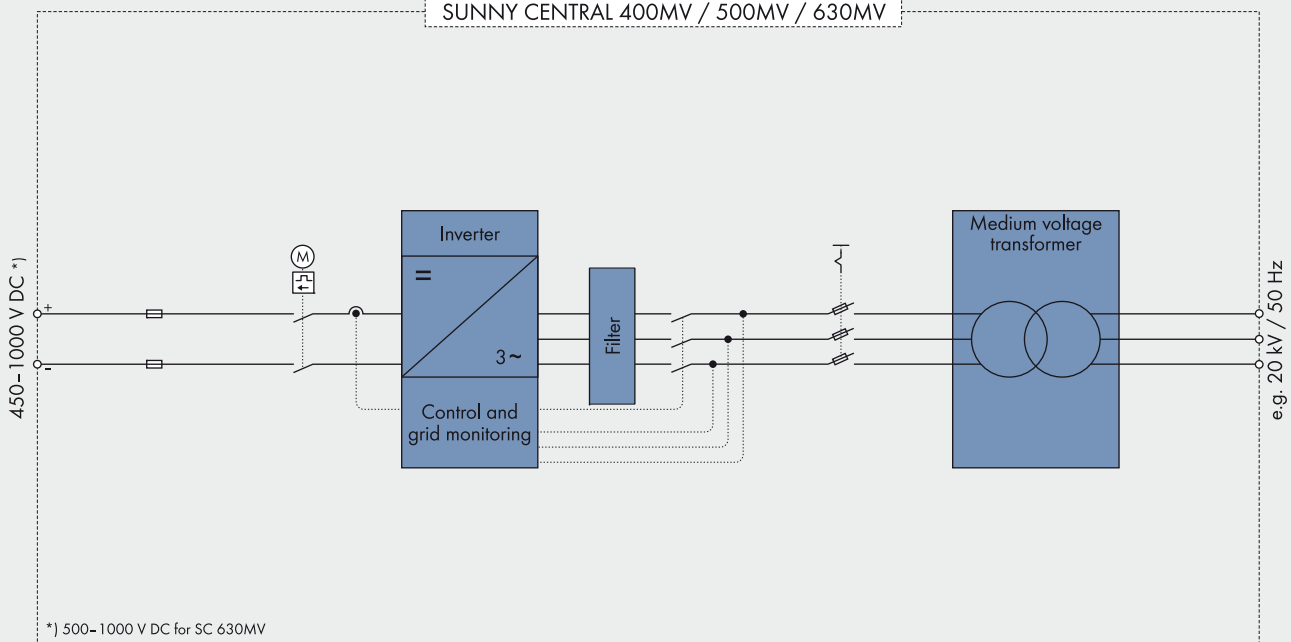

\*) 500–1000 V DC for SC 630MV

# SUNNY CENTRAL for direct medium-voltage feed-in 400MV / 500MV / 630MV

Technical data	Sunny Central 400MV	Sunny Central 500MV
<b>Input (DC)</b>		
Max. DC power (@ cos φ = 1)	455 kW	567 kW
Max. input voltage	1000 V	1000 V
MPP voltage range (@ 25 °C / @45 °C at 50 Hz) <sup>1</sup>	450 V – 820 V / 450 V – 820 V	450 V – 820 V / 450 V – 820 V
MPP voltage range (@ 25 °C at 60 Hz) <sup>1</sup>	450 V – 820 V	450 V – 820 V
Rated input voltage	500 V	500 V
Max. input current	993 A	1242 A
Min. input voltage	450 V	450 V
Number of independent MPP inputs	1	1
Number of DC inputs	(8 + 8) + 2 DCHV	(8 + 8) + 2 DCHV
<b>Output (AC)</b>		
Rated power (@ 25 °C) / nominal AC power (@ 45 °C)	440 kVA / 400 kVA	550 kVA / 500 kVA
Nominal AC voltage / range	20000 V / 18000 V – 22000 V	20000 V / 18000 V – 22000 V
AC power frequency / range	50 Hz, 60 Hz / 47 Hz ... 63 Hz	50 Hz, 60 Hz / 47 Hz ... 63 Hz
Rated power frequency / rated grid voltage	50 Hz / 20000 V	50 Hz / 20000 V
Max. output current	12.7 A	15.9 A
Max. total harmonic factor	< 3 %	< 3 %
Power factor at rated power / displacement power factor adjustable	1 / 0.9 overexcited ... 0.9 underexcited	1 / 0.9 overexcited ... 0.9 underexcited
Feed-in phases / connection phases	3 / 3	3 / 3
<b>Efficiency<sup>2</sup></b>		
Max. efficiency / European weighted efficiency	97.7 % / 97.2 %	97.8 % / 97.3 %
<b>Protective devices</b>		
DC disconnect device	Motor-driven DC switch-disconnector	
AC disconnect device	Optionally (switch-disconnector with HH fuses)	
DC overvoltage protection / AC overvoltage protection on the LV side	Type II surge arrester / type I surge arrester	
Grid monitoring	●	●
Ground-fault monitoring / remote-controlled ground-fault monitoring	● / ○	● / ○
Insulation monitoring	●	●
Galvanic isolation	●	●
Protection class (according to IEC 62103) <sup>3</sup>	I	I
<b>General data</b>		
Dimensions (W / H / D)	5300 / 3600 / 2500 mm (208.7 / 141.7 / 98.4 inch)	
Weight	30000 kg / 66139 lb	30000 kg / 66139 lb
Operating temperature range	-20 °C ... +45 °C / -4 °F ... +113 °F	-20 °C ... +45 °C / -4 °F ... +113 °F
Max. self-consumption (operation) / self-consumption (night)	1500 W <sup>7</sup> / < 100 W + 720 W <sup>5</sup>	1500 W <sup>7</sup> / < 100 W + 720 W <sup>5</sup>
External auxiliary supply voltage / external back-up fuse for auxiliary power supply	3 x 230 V, 50 / 60 Hz / B 32 A, 3-pin	
Cooling principle (inverter / transformer)	Forced cooling / natural convection	
Degree of protection: electronics / connection area (according to IEC 60529)	IP20 / IP54	IP20 / IP54
Application	In unprotected outdoor environments	In unprotected outdoor environments
Max. permissible value for relative humidity (non-condensing)	15 % ... 95 %	15 % ... 95 %
Max. operating altitude above MSL	1000 m	1000 m
Fresh-air consumption	6200 m <sup>3</sup> /h	6200 m <sup>3</sup> /h
<b>Features</b>		
DC connection	Ring terminal lug / cage clamp	Ring terminal lug / cage clamp
AC connection, MV side	External taper angle plug	External taper angle plug
Display	LC text display	LC text display
Communication / protocols	Ethernet, Modbus	Ethernet, Modbus
Sunny String-Monitor	RS485	RS485
Analog inputs / overvoltage protection for analog inputs	2 x Ain <sup>4</sup> / ○	2 x Ain <sup>4</sup> / ○
Transformer for auxiliary power supply	○	○
Medium-voltage transformer with amorphous core	○	○
Medium-voltage switchgear	○	○
Color enclosure / door / base / roof	RAL 7035 / 7024 / 7024 / 7024	
Certificates and approvals (more available on request)	EN 61000-6-2, EN 61000-6-4, IEC 62271-202, EMC compliant, CE compliant, Arrêté du 23/04/08, R.D. 1663 / 2000, R.D. 661 / 2007, BDEW-MSRL / FGW / TR8 <sup>6</sup>	
● Standard feature ○ Optional feature – Not available		
Type designation	SC 400MV-11	SC 500MV-11



- <sup>1</sup> At 1.05  $V_{AC, nom}$  and  $\cos \varphi = 1$   
<sup>2</sup> Efficiency measured without auxiliary power supply at  $V_{DC} = 500$  V  
<sup>3</sup> Information based on inverter  
<sup>4</sup> 1 x irradiation sensor and 1 x pyranometer for each inverter  
<sup>5</sup> Separated according to consumption of the inverter and open-circuit losses of the transformer  
<sup>6</sup> With limited dynamic grid support  
<sup>7</sup> Max. power in a phase for each inverter < 1400 W (asymmetrical consumption)

**Please note:** In certain countries the substations may differ from the concept shown in the images.

Technical data	Sunny Central 630MV	
<b>Input (DC)</b>		
Max. DC power (@ $\cos \varphi = 1$ )	723 kW	
Max. input voltage	1000 V	
MPP voltage range (@ 25 °C / @45 °C at 50 Hz) <sup>1</sup>	500 V – 820 V / 500 V – 820 V	
MPP voltage range (@ 25 °C at 60 Hz) <sup>1</sup>	510 V – 820 V	
Rated input voltage	550 V	
Max. input current	1422 A	
Min. input voltage	500 V	
Number of independent MPP inputs	1	
Number of DC inputs	(8 + 8) + 2 DCHV	
<b>Output (AC)</b>		
Rated power (@ 25 °C) / nominal AC power (@ 45 °C)	700 kVA / 630 kVA	
Nominal AC voltage / range	20000 V / 18000 V – 22000 V	
AC power frequency / range	50 Hz, 60 Hz / 47 Hz ... 63 Hz	
Rated power frequency / rated grid voltage	50 Hz / 20000 V	
Max. output current	20.2 A	
Max. total harmonic factor	< 3 %	
Power factor at rated power / displacement power factor adjustable	1 / 0.9 overexcited ... 0.9 underexcited	
Feed-in phases / connection phases	3 / 3	
<b>Efficiency<sup>2</sup></b>		
Max. efficiency / European weighted efficiency	97.9 % / 97.5 %	
<b>Protective devices</b>		
DC disconnect device	Motor-driven DC switch-disconnector	
AC disconnect device	Optionally (switch-disconnector with HH fuses)	
DC overvoltage protection / AC overvoltage protection on the LV side	Type II surge arrester / type I surge arrester	
Grid monitoring	●	
Ground-fault monitoring / remote-controlled ground-fault monitoring	● / ○	
Insulation monitoring	●	
Galvanic isolation	●	
Protection class (according to IEC 62103) <sup>3</sup>	I	
<b>General data</b>		
Dimensions (W / H / D)	5300 / 3600 / 2500 mm (208.7 / 141.7 / 98.4 inch)	
Weight	30000 kg / 66139 lb	
Operating temperature range	-20 °C ... +45 °C / -4 °F ... +113 °F	
Max. self-consumption (operation) / self-consumption (night)	1500 W <sup>7</sup> / < 100 W + 800 W <sup>5</sup>	
External auxiliary supply voltage / external back-up fuse for auxiliary power supply	3 x 230 V, 50 / 60 Hz / B 32 A, 3-pin	
Cooling principle (inverter / transformer)	Forced cooling / natural convection	
Degree of protection: electronics / connection area (according to IEC 60529)	IP20 / IP54	
Application	In unprotected outdoor environments	
Max. permissible value for relative humidity (non-condensing)	15 % ... 95 %	
Max. operating altitude above MSL	1000 m	
Fresh-air consumption	6200 m <sup>3</sup> /h	
<b>Features</b>		
DC connection	Ring terminal lug / cage clamp	
AC connection, MV side	External taper angle plug	
Display	LC text display	
Communication / protocols	Ethernet, Modbus	
Sunny String-Monitor	RS485	
Analog inputs / overvoltage protection for analog inputs	2 x Ain <sup>4</sup> / ○	
Transformer for auxiliary power supply	○	
Medium-voltage transformer with amorphous core	○	
Medium-voltage switchgear	○	
Color enclosure / door / base / roof	RAL 7035 / 7024 / 7024 / 7024	
Certificates and approvals (more available on request)	EN 61000-6-2, EN 61000-6-4, IEC 62271-202, EMC compliant, CE compliant, Arrêté du 23/04/08, R.D. 1663 / 2000, R.D. 661 / 2007, BDEW-MSRL / FGW / TR8 <sup>6</sup>	
● Standard feature ○ Optional feature – Not available		
Type designation	SC 630MV-11	



#### Precise

- Perfect monitoring of all PV strings in the field

#### Flexible

- The Sunny String-Monitor is available with various connection possibilities for string connections
- For grounded or non-grounded PV arrays upon request
- String monitoring with 8, 16 or 24 measurement channels
- Available upon request with remote-controlled DC switch



## SUNNY STRING-MONITOR

Insurance for solar yields

The specs on monitoring: by precisely comparing individual string currents, power deviations in the PV array are accurately detected using the Sunny Central String-Monitor and are analyzed in the inverter directly. Alongside the measurement of string currents, the device features a string fuse protection as well as an overvoltage protection device and can be mounted as a wall or base unit.





#### Flexible

- Project-specific configuration

#### Durable

- Industrial components
- Extended temperature range

#### Secure

- Redundant electricity supply and compliance with the medium-voltage directive
- Use of ring topologies
- Remote monitoring, diagnosis and configuration



## COMMUNIT

### Flexible configuration options for optimized communications

The Communit communication distributor integrates all the communication components and their copper or optical fiber wiring for large-scale PV plants. The Communit is flexible and can be configured for any plant or communications concept. The highest level of availability is guaranteed by a redundant electricity supply and the use of Ethernet ring topologies by the managed network switch. Disturbances can be quickly detected thanks to the remote monitoring, diagnosis and configuration features. The Communit's robust enclosure can be used indoors and outdoors. The communications distributor can be mounted as a wall, base or mast unit, even in outdoor applications.







#### Economical

- More energy due to 1,000 V DC voltage
- Direct deployment in the field due to outdoor enclosure

#### Efficient

- Full nominal power at ambient temperatures up to 50 °C
- 10% additional power in continuous operation at ambient temperatures up to 25 °C

#### Flexible

- DC voltage range configuration possible
- Integrated AC disconnect according to NEC requirements

#### Reliable

- Easy and safe installation due to a separate connection area
- Powerful grid management functions (including LVRT))
- IEEE 1547 compliant



## SUNNY CENTRAL 500CP-US / 630CP-US / 720CP-US / 750CP-US / 800CP-US

Cost-optimized power for North America's power distribution grid

Individual performance at an industrial level. In combination with an external transformer, the Sunny Central CP-US family can be connected to any power distribution grid imaginable, while actively supporting the entire system with new grid management functions. And it's in the top of its power class with a peak efficiency of 98.7 percent. The CP-US family is fully UL-listed at a 1,000 V with integrated AC disconnect according to NEC requirements. The outdoor enclosure with OptiCool cooling concept and a separate connection area ensure simple installation and low system costs. SMA also supplies complete MV power platforms with two inverters, a transformer and an additional Disconnect Unit.

Efficiency curve SUNNY CENTRAL 800CP-US

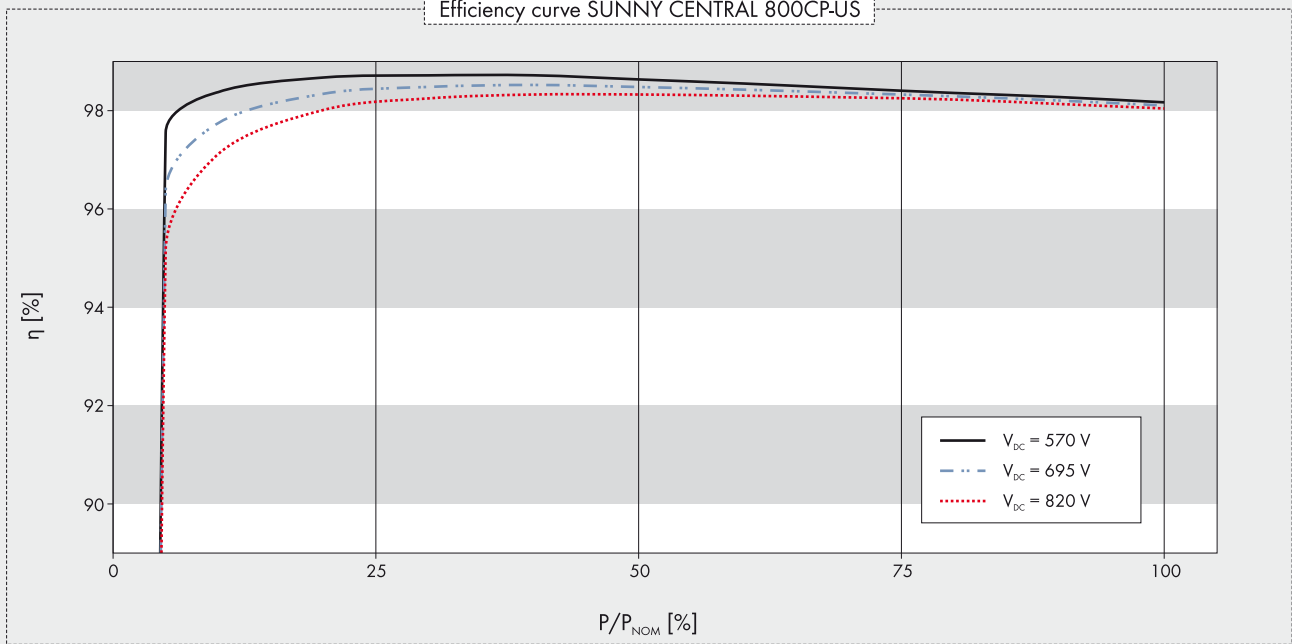

SUNNY CENTRAL 500CP-US / 630CP-US / 720CP-US / 750CP-US / 800CP-US

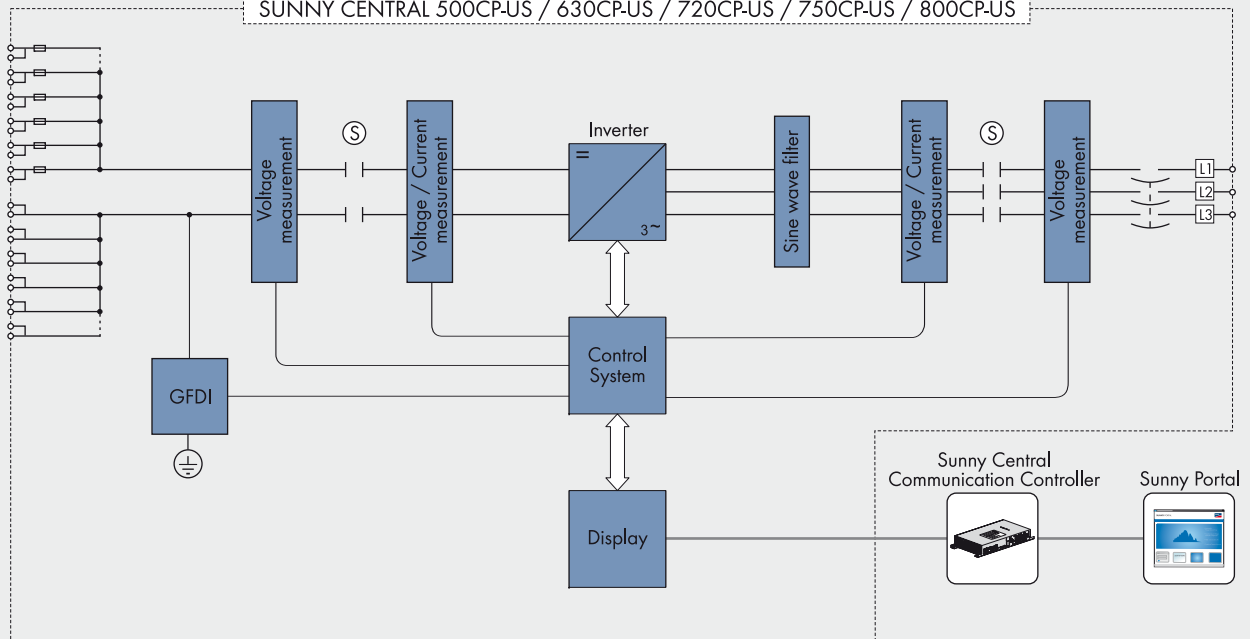

# SUNNY CENTRAL 500-US / 630-US / 720CP-US / 750CP-US / 800CP-US

Technical data	Sunny Central 500CP-US	Sunny Central 630CP-US
<b>Input (DC)</b>		
Max. DC power (@ $\cos \varphi = 1$ )	560 kW	713 kW
Max. input voltage <sup>1</sup>	1000 V	1000 V
MPP voltage range (@ 25 °C / @ 50 °C at 60 Hz)	430 V – 820 V / 430 V – 820 V <sup>1</sup>	500 V – 820 V / 500 V – 820 V <sup>1</sup>
Rated input voltage	480 V	550 V
Max. input current	1250 A	1350 A
Min. input voltage / $V_{MPP\_min}$ at $I_{MPP} < I_{DCmax}$	429 V	498 V
Number of independent MPP inputs	1	1
Number of DC inputs	1; 6 – 9	1; 6 – 9
<b>Output (AC)</b>		
Rated power (@ 25 °C) / nominal AC power (@ 50 °C)	550 kVA / 500 kVA	700 kVA / 630 kVA
Rated grid voltage / nominal AC voltage range	270 V / 243 V – 297 V	315 V / 284 V – 347 V
AC power frequency / range	50 Hz, 60 Hz / 47 Hz ... 63 Hz	50 Hz, 60 Hz / 47 Hz ... 63 Hz
Rated power frequency / rated grid voltage	50 Hz, 60 Hz / 270 V	50 Hz, 60 Hz / 315 V
Max. output current	1176 A	1283 A
Max. total harmonic factor	< 3 %	< 3 %
Power factor at rated power / displacement power factor adjustable	1 / 0.8 overexcited – 0.8 underexcited	
Feed-in phases / connection phases	3 / 3	3 / 3
<b>Efficiency<sup>4</sup></b>		
Max. efficiency / European weighted efficiency / CEC efficiency	98.5 % / 98.3 % / 98.0 %	98.5 % / 98.3 % / 98.0 %
<b>Protective devices</b>		
DC disconnect device	DC contactor	
AC disconnect device	AC circuit breaker	
DC overvoltage protection	Surge Arrester Type II	
Grid monitoring	●	●
Ground-fault monitoring	○	○
Lightning protection (according to IEC 62305-1)	Lightning protection level III	Lightning protection level III
Insulation monitoring	○	○
Surge arresters for auxiliary power supply	●	●
Protection class (according to IEC 62103) / overvoltage category (according to IEC 60664-1)	I / IV	I / IV
<b>General data</b>		
Dimensions (W / H / D)	2562 / 2279 / 956 mm (101 / 90 / 38 inches)	
Weight	1800 kg / 4000 lb	1800 kg / 4000 lb
Operating temperature range	-25 °C ... +50 °C / -13 °F ... +122 °F	-25 °C ... +50 °C / -13 °F ... +122 °F
Noise emission <sup>3</sup>	60 db(A)	60 db(A)
Max. self-consumption (in operation) / self-consumption (at night)	1700 W <sup>2</sup> / < 100 W	1700 W <sup>2</sup> / < 100 W
External auxiliary supply voltage	230 / 400 V (3/N/PE)	230 / 400 V (3/N/PE)
Cooling concept	OptiCool	OptiCool
Degree of protection: electronics / connection area (according to IEC 60529)	NEMA 3R / NEMA 3R	NEMA 3R / NEMA 3R
Degree of protection (according to IEC 60721-3-4)	4C2, 4S2	4C2, 4S2
Application	In unprotected outdoor environments	In unprotected outdoor environments
Max. permissible value for relative humidity (non-condensing)	15 % ... 95 %	15 % ... 95 %
Max. operating altitude above mean sea level	2000 m	2000 m
Fresh-air consumption (inverter)	3000 m <sup>3</sup> /h	3000 m <sup>3</sup> /h
<b>Features</b>		
DC connection	Ring terminal lug / cage clamp	Ring terminal lug / cage clamp
AC connection	Ring terminal lug / cage clamp	Ring terminal lug / cage clamp
Display	○	○
Communication / protocols	Ethernet (optical fiber optional), Modbus	Ethernet (optical fiber optional), Modbus
Communication with Sunny String-Monitor	RS485	RS485
Transformer for auxiliary power supply	○	○
SC-COM	●	●
Color of enclosure, door, base, roof	RAL 9016 / 9016 / 7005 / 7004	
Warranty: 5 / 10 / 15 / 20 / 25 years	● / ○ / ○ / ○ / ○	● / ○ / ○ / ○ / ○
Certificates and approvals (more available on request)	EMC conformity according to FCC, Part 15, Class A, UL 1741, UL 1998, IEEE 1547	
● Standard equipment ○ Optional features – Not available		
Type designation	SC 500CP-US-10	SC 630CP-US-10

- <sup>1</sup> At 1.00 U<sub>AC, nom</sub> and cos φ = 1
- <sup>2</sup> Self-consumption at rated operation
- <sup>3</sup> Sound pressure level at a distance of 10 m
- <sup>4</sup> Efficiency measured without auxiliary power supply

Sunny Central 720CP-US	Sunny Central 750CP-US	Sunny Central 800CP-US	
808 kW	853 kW	898 kW	
1000 V	1000 V	1000 V	
525 V - 820 V / 525 V - 820 V <sup>1</sup>	545 V - 820 V / 545 V - 820 V <sup>1</sup>	570 V - 820 V / 570 V - 820 V <sup>1</sup>	
565 V	595 V	620 V	
1600 A	1600 A	1600 A	
515 V	545 V	568 V	
1	1	1	
1; 6 - 9	1; 6 - 9	1; 6 - 9	
792 kVA / 720 kVA	836 kVA / 760 kVA	880 kVA / 800 kVA	
324 V / 292 V - 356 V	342 V / 308 V - 376 V	360 V / 324 V - 396 V	
50 Hz, 60 Hz / 47 Hz ... 63 Hz	50 Hz, 60 Hz / 47 Hz ... 63 Hz	50 Hz, 60 Hz / 47 Hz ... 63 Hz	
50 Hz, 60 Hz / 324 V	50 Hz, 60 Hz / 342 V	50 Hz, 60 Hz / 360 V	
1411 A	1411 A	1411 A	
< 3 %	< 3 %	< 3 %	
	1 / 0.8 overexcited - 0.8 underexcited		
3 / 3	3 / 3	3 / 3	
98.6 % / 98.4 % / 98.0 %	98.6 % / 98.4 % / 98.0 %	98.7 % / 98.4 % / 98.5 %	
DC contactor			
AC circuit breaker			
Surge Arrester Type II			
●	●	●	
○	○	○	
Lightning protection level III	Lightning protection level III	Lightning protection level III	
○	○	○	
●	●	●	
I / IV	I / IV	I / IV	
2562 / 2279 / 956 mm (101 / 90 / 38 inches)			
1800 kg / 4000 lb	1800 kg / 4000 lb	1800 kg / 4000 lb	
-25 °C ... +50 °C / -13 °F ... +122 °F	-25 °C ... +50 °C / -13 °F ... +122 °F	-25 °C ... +50 °C / -13 °F ... +122 °F	
60 db(A)	60 db(A)	61 db(A)	
1700 W <sup>2</sup> / 100 W	1700 W <sup>2</sup> / < 100 W	1700 W <sup>2</sup> / < 100 W	
230 / 400 V (3/N/PE)	230 / 400 V (3/N/PE)	230 / 400 V (3/N/PE)	
OptiCool	OptiCool	OptiCool	
NEMA 3R / NEMA 3R	NEMA 3R / NEMA 3R	NEMA 3R / NEMA 3R	
4C2, 4S2	4C2, 4S2	4C2, 4S2	
In unprotected outdoor environments	In unprotected outdoor environments	In unprotected outdoor environments	
15 % ... 95 %	15 % ... 95 %	15 % ... 95 %	
2000 m	2000 m	2000 m	
3000 m <sup>3</sup> /h	3000 m <sup>3</sup> /h	3000 m <sup>3</sup> /h	
Ring terminal lug / cage clamp	Ring terminal lug / cage clamp	Ring terminal lug / cage clamp	
Ring terminal lug / cage clamp	Ring terminal lug / cage clamp	Ring terminal lug / cage clamp	
○	○	○	
Ethernet (optical fiber optional), Modbus	Ethernet (optical fiber optional), Modbus	Ethernet (optical fiber optional), Modbus	
RS485	RS485	RS485	
○	○	○	
●	●	●	
RAL 9016 / 9016 / 7005 / 7004			
● / ○ / ○ / ○ / ○	● / ○ / ○ / ○ / ○	● / ○ / ○ / ○ / ○	
EMC conformity according to FCC, Part 15, Class A, UL 1741, UL 1998, IEEE 1547			
SC 720CP-US-10	SC 750CP-US-10	SC 800CP-US-10	



#### Reliable

- Peak efficiency of 98.6 %
- Suitable for ambient temperatures of up to 122 °F / 50 °C
- Intelligent temperature management OptiCool

#### Low system costs

- Direct deployment in the field due to outdoor enclosure
- Easy installation thanks to separate connection area
- Simple connection with all power distribution grids

#### Strong peripherals

- NEC 2011 compliant Disconnect Unit
- Circuit combiner boxes
- Sunny Central String-Monitor-US
- Available as integrated complete solution

#### Includes grid management

- Reactive power control
- Active power control
- Anti-islanding



## SUNNY CENTRAL 500HE-US

The ideal solution for PV power stations in North America

Individual performance at an industrial level: in combination with an external transformer, the Sunny Central 500HE-US can be connected to any imaginable power distribution grid, which it also actively supports with the new grid management function. The outdoor enclosure with OptiCool cooling concept and the separate connection area ensure simple installation and low system costs. With its peak efficiency of 98.6 %, it outdoes all other devices in its power class. SMA also supplies complete megawatt skids with two inverters and external AC/DC disconnectors located centrally in a Disconnect Unit and a transformer.



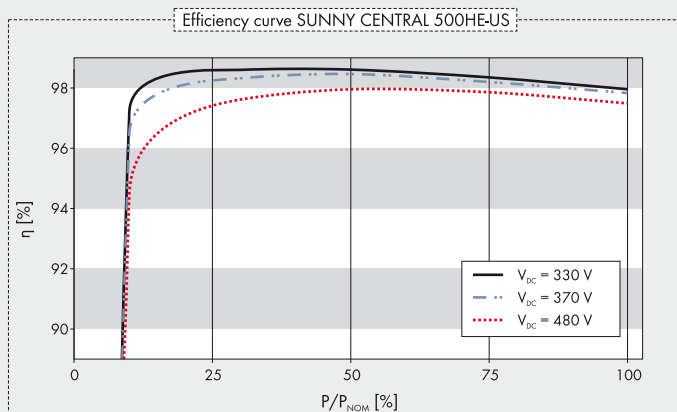

- <sup>1</sup> Specifications apply to irradiation values at STC
- <sup>2</sup> AC voltage range for full active power: 196 V - 210 V
- <sup>3</sup> Measured without an auxiliary power supply at  $V_{DC} = 330$  V
- <sup>4</sup> Max. temperature for nominal conditions +45 °C / +113 °F
- <sup>5</sup> Sound pressure level at a distance of 10 m
- <sup>6</sup> No reduction in power up to 1,000 m; above it, 5% for every 1,000 m

Technical data	Sunny Central 500HE-US	
<b>Input (DC)</b>		
Max. DC power (@ $\cos \varphi = 1$ )	513 kW <sup>1</sup>	
Max. input voltage	600 V	
MPP voltage range	330 V - 600 V	
Rated input voltage	380 V	
Min. input voltage	330 V	
Max. input current	1600 A	
Number of independent MPP inputs	1	
Number of DC inputs	6 - 9	
<b>Output (AC)</b>		
Rated power (@ 25 °C) / nominal AC power (@ 50 °C)	500 kVA / 351 kVA	
Nominal AC voltage / range	200 V / 180 V - 220 V <sup>2</sup>	
AC power frequency / range	60 Hz / 59.3 Hz ... 60.5 Hz	
Rated power frequency / rated grid voltage	60 Hz / 200 V	
Max. output current	1470 A	
Max. total harmonic factor	5 %	
Power factor at rated power / displacement power factor adjustable	> 0.99 / 0.9 overexcited ... 0.9 underexcited	
Feed-in phases, connection phases	3 / 3	
<b>Efficiency<sup>3</sup></b>		
Max. efficiency / European weighted efficiency / CEC	98.6 % / 97.9 % / 98.0 %	
<b>Protective devices</b>		
DC disconnect device	Motor-driven contactor	
AC disconnect device	AC circuit breaker	
DC overvoltage protection / AC overvoltage protection	○ / ○	
Grid monitoring	●	
Ground-fault monitoring	●	
Surge arresters for auxiliary power supply	○	
<b>General data</b>		
Dimensions (W / H / D)	2562 / 2277 / 956 mm (101 / 90 / 38 inch)	
Weight	1800 kg / 3970 lb	
Operating temperature range	-25 °C ... +50 °C / -13 °F ... +122 °F <sup>4</sup>	
Noise emission	59.3 db(A) <sup>5</sup>	
Max. self-consumption (operation) / self-consumption (night)	1700 W / < 110 W	
External auxiliary supply voltage	3 x 208 V, 60 Hz	
Cooling concept	OptiCool	
Degree of protection: electronics / connection area (according to IEC 60529)	IP54 / IP23	
Application	In unprotected outdoor environments	
Max. permissible value for relative humidity (non-condensing)	15 % ... 95 %	
Max. operating altitude above MSL	4000 m <sup>6</sup>	
Fresh-air consumption (inverter)	3000 m <sup>3</sup> /h	
<b>Features</b>		
DC connection	Ring terminal lug / cage clamp	
AC connection	Ring terminal lug / cage clamp	
Display	LC graphic display	
Communication / protocols	Ethernet, Modbus, TCP, analog	
Transformer for auxiliary power supply	●	
Plant monitoring	Optionally (via Sunny Portal)	
Color enclosure / door / base / roof	RAL 9016 / 9016 / 7005 / 7004	
Certificates and approvals (more available on request)	EMC conformity according to FCC, Part 15, Class A, UL 1741, UL 1998	
● Standard feature ○ Optional feature – Not available		
Type designation	SC 500HE-US	



**Economical**

- Peak efficiency of 97.5 %
- Direct connection to the 480 V power distribution grid
- Suitable for ambient temperatures of up to 122 °F / 50 °C

**Secure**

- Galvanic isolation
- Weatherproof enclosure
- Integrated data logger
- Simple remote query and maintenance per remote access

**Strong peripherals**

- NEC 2011 compliant Disconnect Unit
- Circuit combiner boxes for string collection
- Sunny Central String-Monitor-US



**SUNNY CENTRAL 250-US / 500-US**

Perfect for commercial plants in North America

The central inverters are ideally suited for commercial projects in North America. The integrated transformer makes direct connection to the low-voltage grid possible and, thanks to the outdoor-rated enclosure with OptiCool cooling concept, the devices can be installed practically anywhere. The peak efficiency of 97.5 percent is remarkable for inverters with transformers. Monitoring and remote maintenance is performed via the integrated data logger, which is accessible through a Modbus, RS485, Ethernet or OPC interface.

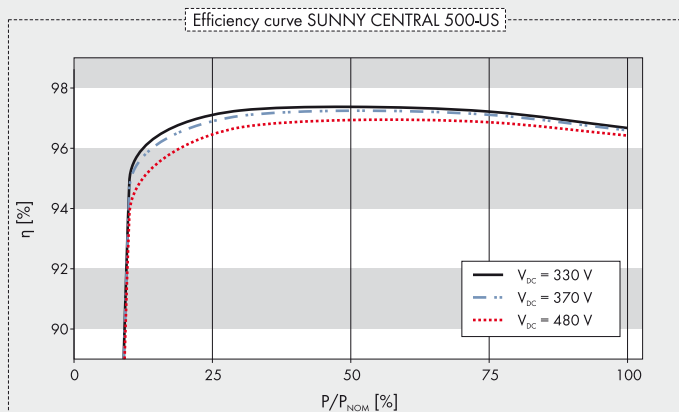

- <sup>1</sup> Specifications apply to irradiation values at STC
- <sup>2</sup> AC voltage range for full active power: 480 V - 514 V
- <sup>3</sup> Measured without an auxiliary power supply at  $V_{DC} = 330$  V
- <sup>4</sup> Max. temperature for nominal conditions +45 °C / +113 °F
- <sup>5</sup> Sound pressure level at a distance of 10 m
- <sup>6</sup> No reduction in power up to 1,000 m; above it, 5% for every 1,000 m

Technical data	Sunny Central 250-US	Sunny Central 500-US
<b>Input (DC)</b>		
Max. DC power (@ $\cos \varphi = 1$ )	260 kW <sup>1</sup>	516 kW <sup>1</sup>
Max. input voltage	600 V	600 V
MPP voltage range	330 V - 600 V	330 V - 600 V
Rated input voltage	380 V	380 V
Min. input voltage	330 V	330 V
Max. input current	800 A	1600 A
Number of independent MPP inputs	1	1
Number of DC inputs	4; 6	6 - 9
<b>Output (AC)</b>		
Rated power (@ 25 °C) / nominal AC power (@ 50 °C)	250 kVA / 173.5 kVA	500 kVA / 351 kVA
Nominal AC voltage / range	277 V / 480 V / 422 V - 528 V <sup>2</sup>	277 V / 480 V / 422 V - 528 V <sup>2</sup>
AC power frequency / range	60 Hz / 59.3 Hz ... 60.5 Hz	60 Hz / 59.3 Hz ... 60.5 Hz
Rated power frequency / rated grid voltage	60 Hz / 480 V	60 Hz / 480 V
Max. output current	300 A	600 A
Max. total harmonic factor	3 %	3 %
Power factor at rated power	> 0.99	> 0.99
Feed-in phases, connection phases	3 / 3	3 / 3
<b>Efficiency<sup>3</sup></b>		
Max. efficiency / European weighted efficiency / CEC efficiency	97.5 % / 96.6 % / 97.0 %	97.4 % / 96.9 % / 97.0 %
<b>Protective devices</b>		
DC disconnect device	Motor-driven contactor	Motor-driven contactor
AC disconnect device	Motor-driven contactor	Motor-driven contactor
DC overvoltage protection / AC overvoltage protection	- / -	o / o
Grid monitoring	●	●
Ground-fault monitoring	●	●
Galvanic isolation	●	●
<b>General data</b>		
Dimensions (W / H / D)	2786 / 2027 / 830 mm (110 / 80 / 33 inch)	3536 / 2027 / 930 mm (140 / 80 / 37 inch)
Weight	1900 kg / 4189 lb	3250 kg / 7165 lb
Operating temperature range	-25 °C ... +50 °C / -13 °F ... +122 °F <sup>4</sup>	-25 °C ... +50 °C / -13 °F ... +122 °F <sup>4</sup>
Noise emission	51.6 db(A) <sup>5</sup>	53.9 db(A) <sup>5</sup>
Max. self-consumption (operation) / self-consumption (night)	800 W / < 70 W	1500 W / < 80 W
Cooling concept	OptiCool	OptiCool
Degree of protection	NEMA 3R	NEMA 3R
Degree of protection (according to IEC 60721-3-4)	4C2, 4S2	4C2, 4S2
Application	In unprotected outdoor environments	In unprotected outdoor environments
Max. permissible value for relative humidity (non-condensing)	15 % ... 95 %	15 % ... 95 %
Max. operating altitude above MSL	4000 m <sup>6</sup>	4000 m <sup>6</sup>
Fresh-air consumption	4000 m <sup>3</sup> /h	6000 m <sup>3</sup> /h
<b>Features</b>		
Display	LC text display	LC text display
Communication / protocols	Ethernet, Modbus, TCP, analog	Ethernet, Modbus, TCP, analog
Transformer for auxiliary power supply	●	●
Plant monitoring	Optionally (via Sunny Portal)	Optionally (via Sunny Portal)
Color enclosure / door / base / roof	RAL 7032 / 7032 / 7045 / 7045	RAL 7032 / 7032 / 7045 / 7045
Certificates and approvals (more available on request)	EMC conformity according to FCC, Part 15, Class A, UL 1741, UL 1998	EMC conformity according to FCC, Part 15, Class A, UL 1741, UL 1998
● Standard feature ○ Optional feature - Not available		
Type designation	SC 250U	SC 500U



#### Compliant

- Full compliance with all NEC-2011 safety rules

#### Flexible

- Suitable for all SMA inverters used in the US
- Extendable up to six disconnectors
- Available with or without AC switch

#### Compact

- All switch-disconnectors in a single enclosure
- Available as an accessory of a complete MV block

#### Secure

- Visible switch position and fast handling in case of hazardous situation
- Reliable disconnection, even under full load



## DISCONNECT UNIT

Complete NEC conformity, compact in a single switch cabinet

The new Disconnect Unit combines all safety measures into a single, compact enclosure. The device is ideally suited to all Sunny Central inverters with plant voltage ranging from 600 to 1000 V currently in use in North America. All switch-disconnectors are tightly concentrated in a small space for quick access in a hazardous situation. They can operate under full loads and feature the ampacity reserves required by NEC 2011. The switching handles installed on the front enable you to immediately recognize the switch position. This guarantees a secure and fast disconnection of all energy from the inverter in case of emergency or maintenance.







#### Economical

- Optimal failure detection for high yields
- A maximum of nine devices necessary for monitoring the entire PV array

#### Precise

- NEMA 3R compliant DC distributor box with integrated current measurement
- String current monitoring with extremely high measuring accuracy (deviation  $< \pm 1.25\%$ )

#### Flexible

- Three different versions for the best possible plant design
- Optionally suitable for installation near the coast, for example

#### User-friendly

- Comfortable installation preparation due to detachable side and base plates
- Uncomplicated configuration of the string-failure detection monitoring



## SUNNY CENTRAL STRING-MONITOR-US

Insurance for solar yields in North America

By precisely measuring and comparing individual string currents, power deviations in the PV array are accurately detected using the Sunny Central String-Monitor-US and are analyzed in the Sunny Central inverter directly. According to preference, the Sunny Central String-Monitor-US is delivered in an enclosure for wall or pole mounting with degree of protection Nema 3R. There are three variants of string fuse protection, which all comply with the NEC standard, for the measurement of the string currents. Thus, the Sunny Central String-Monitor-US is ideally suited for use in the North American photovoltaic market.





#### Technical consulting

- Based on 20 years of project experience
- Advice on planning, design and dimensioning

#### Engineering

- Technical planning of the DC and AC side connections
- Load-flow calculations with simulation tools

#### Project management

- Seamless order execution and flexible manufacturing
- Dedicated contact person and coordinated commissioning

#### Service

- Global service infrastructure at 85 locations
- Modular service concept with custom contract options

## Top-notch project management

Worldwide expertise and seamless support

From initial consulting to final commissioning: with SMA, you will always have a team of experienced specialists at your side to help you achieve the best configuration and highest yields with our PV power station. 20 years of worldwide project experience and the concentrated expertise of SMA employees guarantee maximum success. Your PV power station projects will be in good hands for its entire electrical endurance.

## Successful right from the start

Consulting and planning support, system technology, project management and service from one source: with SMA as a project partner, customers can ensure the success of their power plant project right from the very beginning.

Decades of expertise, worldwide professional expertise and individually configurable complete solutions with system technology guarantee excellent conditions for any PV project. SMA's expertise in power plant project is renowned, and we will use it to assist customers from the initial planning stage and seamless order execution to successful commissioning and globally accessible service infrastructure.

The initial inquiry for the planning of a large-scale PV plant already sets the ball rolling at SMA. Our team of specialists is waiting for your questions on plant dimensioning, modules and inverters, and solutions involving communications and specific regional conditions on grid requirements and access. These specialists will conduct in-depth consultations to determine the optimum design for any large-scale PV plant.

Qualified project managers ensure that the order is executed properly and the components are delivered on time. They also work with the service team to coordinate the successful commissioning. The modular SMA service agreements can be customized for anywhere in the world.

Customers will have an SMA customer service representative at their side for the entire service life of the PV power station. These representatives are the right contact person for you in all project phases with their plant-specific knowledge.

## All services at a glance

### Technical consulting

- Advice on planning, design and dimensioning
- Definition of components for the specific PV modules in use
- Arrangement of all system components
- Determination and evaluation of local grid requirements
- Creation of detailed customer-specific solutions

### Engineering

- Creation of a DC wiring plan
- Determination of combiners in the module field
- Definition of lines and fuses
- Draft report on what communication devices are necessary
- Static load-flow calculations with simulation tools
- Planning for the AC grid connection

### Project management

- Seamless order processing and flexible manufacturing based on customer input
- Flexible adjustment of the delivery chain with guaranteed delivery deadlines
- Construction site coordination for the delivery of components
- On-site coordination of all processes
- Consulting from dedicated contact person in all project phases
- Coordinated commissioning with SMA Service
- Optimal parameterization of devices for the project

### Service

The following pages contain more information on the global SMA service infrastructure and modular service concept.

## End-to-end project management

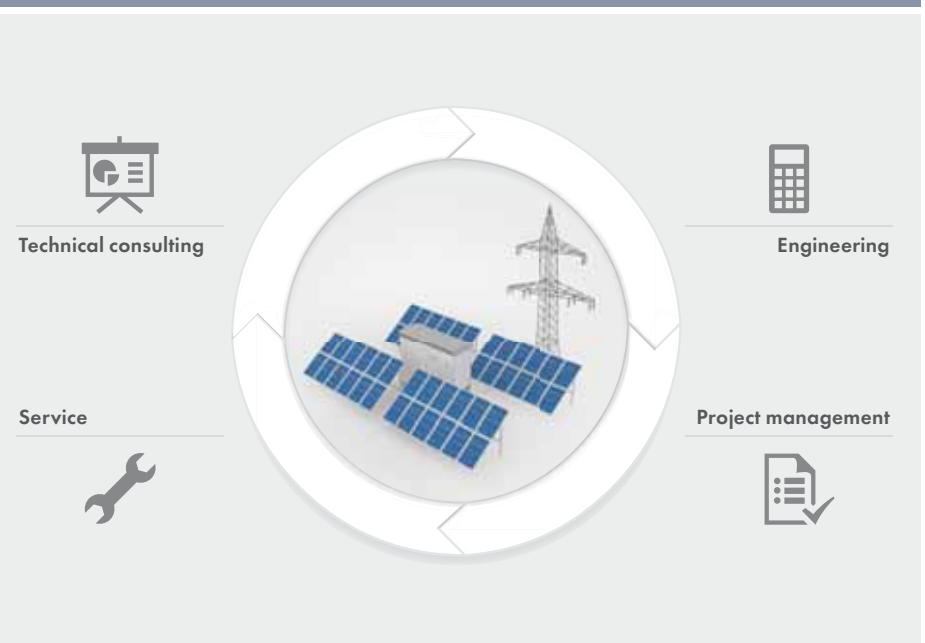



#### Customer-oriented

- Professional on-site maintenance and repair
- Telephone support through our team of experts at the SMA Service Line

#### Assured returns

- Technical availability up to 97, 98 or 99 percent
- Five-year warranty on all Sunny Central inverters

#### Flexible

- Service and maintenance contracts up to 20 years
- Services can be combined on an individual basis
- Contract conclusion within the total warranty period
- Contract extension within the first ten years possible

## SMA Service for centralized inverter solutions

Security thanks to modular design

PV power stations are profitable and secure investment opportunities. In combination with the high-yield SMA central inverters, our services ensure optimum plant availability. Our service contracts can be individually and flexibly combined, over a long period of time. With the SMA Sunny Central Service, plant operators can secure their investment for the future.



### **Flexible service agreements for the plant's entire service life**

Do you hand over repair work or do it yourself? Do you take out a device availability or supervise the plant yourself? With the Sunny Central Service modules, services can be flexibly combined. The customer decides which modules he wants – now and later. It's possible to conclude the contract within the total warranty period of five years. A contract can be extended up to ten years after commissioning.

### **Four modules, many advantages**

The basis for the highest operational security: with our maintenance contract, we check a plant on-site every two years according to the maintenance schedule (work and material costs included). The replacement part warranty guarantees our customers original parts now and in the future and with it, price security for the whole operational life. The Diagnosis + Repair module ensures professional on-site support. On request, First Level Support, i.e., light repair work, can be provided as an individual service. In addition, the inverter availability of 97, 98 or 99 percent is a financial safeguard against all eventualities.

### **Our SMA Service Line – A direct link to the experts**

One telephone number, one contact person, one solution: through the SMA Service Line, our Sunny Central team provides fast and efficient telephone support to contractors and plant operators. With SMA plant monitoring devices such as the Sunny WebBox, our support staff can also undertake quick and direct remote diagnosis.

### **SMA service on-site – Deployment worldwide**

If services are required, we're quickly on-site. We have a well-established international service infrastructure, currently in 18 countries. From on-site diagnosis to repairs and maintenance in the field, we are ready to support our customers worldwide.

### **We would be glad to assist you**

Do you have questions or need individual assistance? If so, please contact us. We will be glad to assist you in compiling a suitable service package for your needs. The opening hours and telephone numbers of our expert teams are listed on our website at [www.sma.de/service](http://www.sma.de/service).

We have also compiled all the information in our service brochures, which you can order for free or download directly from our website.





# OFF-GRID SOLUTIONS

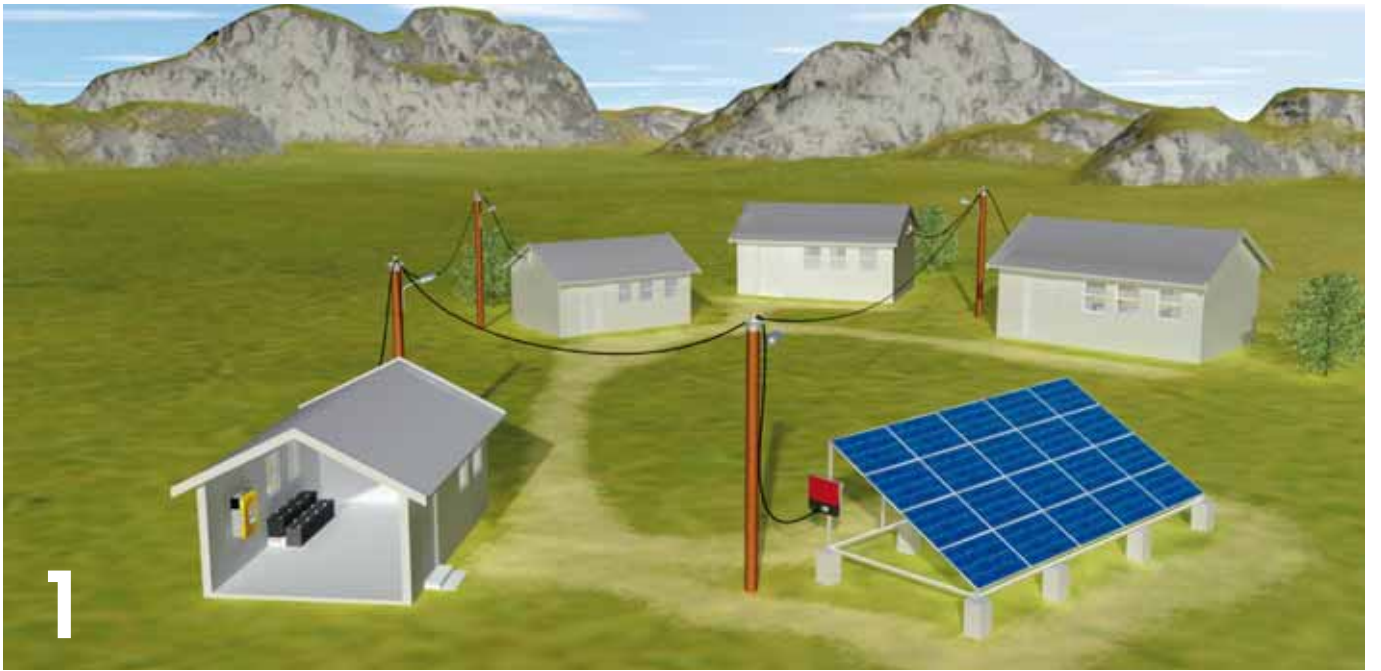



# Off-grid inverters by SMA: System manager for all types of energy generators

Secure electricity supply for off-grid systems generating 1 to 300 kilowatts: the Sunny Island battery inverter forms a standard AC voltage grid into which both the electric loads and energy generators can be integrated without a problem. With this AC coupling and the Sunny Island as a system manager, SMA provides an innovative solution for supplying energy to remote locations or for creating an emergency power supply for areas with unstable grids.

## Grid former and system manager

As a grid former, the Sunny Island forms a stable stand-alone grid by keeping voltage and frequency within the permissible limits at all times. Furthermore, as an intelligent system manager the battery inverter provides optimal grid stability at all times. If the PV generator produces too much energy, the Sunny Island automatically charges the battery with the energy surplus. If there is an energy deficit, it supplies the power distribution grid with the energy from the batteries. Its battery management ensures that the Sunny Island always knows the state of charge of the battery, and that it uses it optimally. This has a positive effect on battery life. Thanks to its highly developed load and

energy management, the Sunny Island also makes further decisions: if there is high electricity demand, the Sunny Island can, for example, start a diesel generator or – according to their relevance within the system – it can also disconnect loads. If the batteries are fully charged and there is little demand, it can reduce the PV plant's electricity production automatically.

## Flexible grid layout

Via the AC stand-alone grid different energy generators can be connected on site, depending on their availability: according to their availability: PV arrays, small wind-energy turbines or water turbines, but also diesel generators as a backup. SMA stand-alone grids can be set up quickly and can be expanded cost-effectively if the energy demand increases.

## Expandable up to 300 kW

Stand-alone grids using the Sunny Island 2012, 2224 or 5048 can be expanded cost-effectively through the parallel connection of several devices, single-phase or three-phase. In systems of more than 15 kilowatts, each three Sunny Island 5048 inverters and

one battery form a cluster. SMA multicluster technology allows a total power of up to 300 kilowatts by connecting several clusters in parallel. The advantage: even if a cluster fails, only one sub-system is affected – the off-grid power supply is therefore extremely secure. For smaller systems, SMA offers the Sunny Island Charger, an MPP charge controller for a DC connection of the PV plant and batteries. This makes SMA the only company in the world to offer coordinated solutions for both AC and DC connections.

**1** Stand-alone grids which use the Sunny Island as a system manager guarantee a reliable electricity supply for regions far from the grid and for areas with a weak grid structure. In the self-sufficient energy system, feeders and loads are connected in parallel on the AC side. This makes SMA stand-alone grids especially flexible – they can be set up modularly at any time using standard components, and they can be expanded at any time.

**2** If energy demand increases, the off-grid system can be expanded to 300 kilowatts of power effortlessly. Depending on the energy sources available, in addition to the PV energy, other renewable energy carriers, like the wind or hydropower, or diesel generators can complement the stand-alone grid. A battery stores excess energy and makes it available when needed.

**3** Unused energy during the day is also available at night thanks to the battery storage. Important loads – in hospital wards, for example – can run around the clock this way, without loud and smelly diesel motors. In addition, connecting street lighting can provide more security in the street.

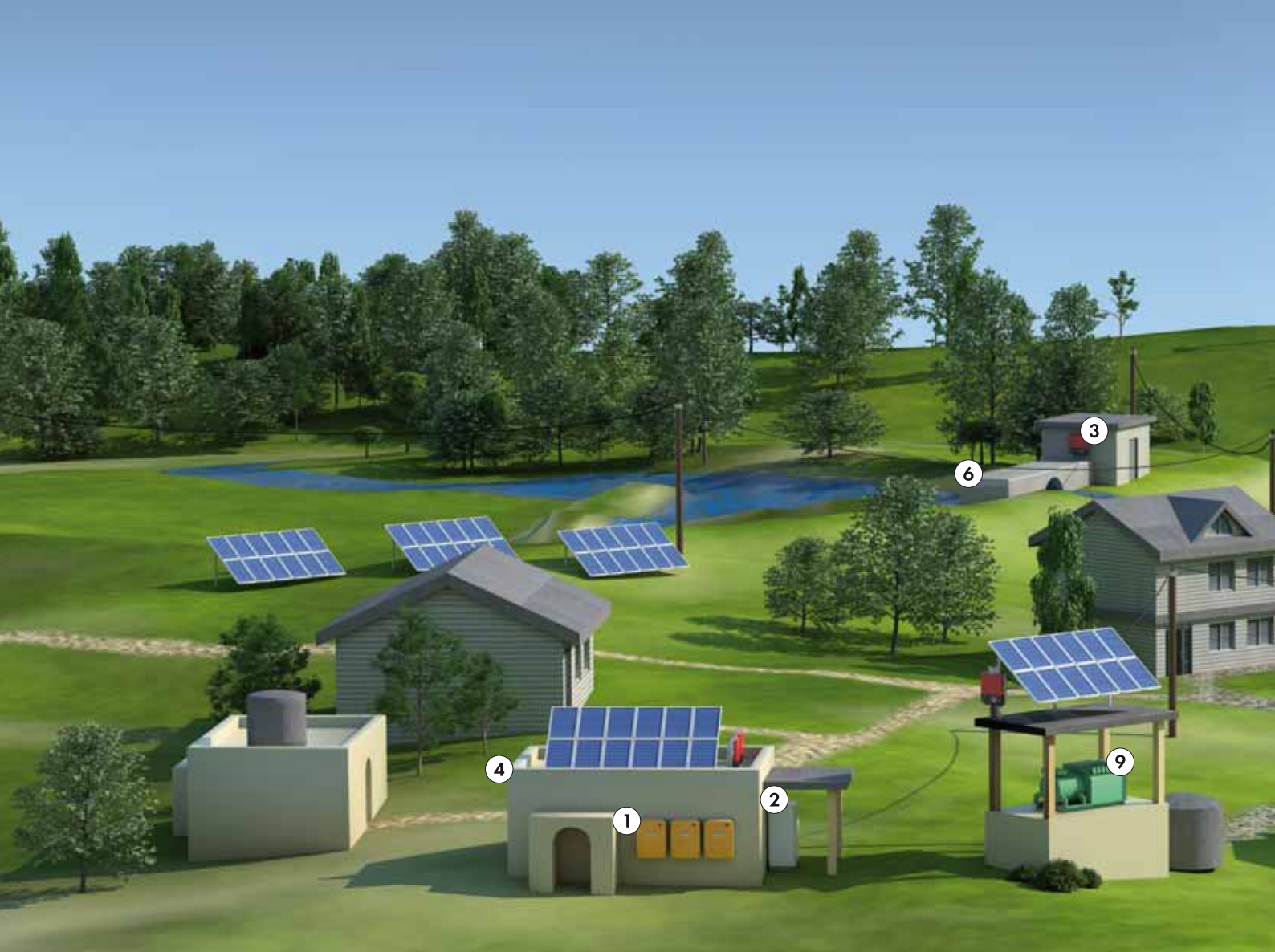

# Solar power for everyone. Everywhere.

Off-grid systems for a reliable energy supply

For more than 30 years, we have had one vision: to provide people all over the world with safe and affordable access to electricity. After all, electricity is the key to clean water, education and health – and it enables greater prosperity for all. For this, we at SMA develop integrated and regenerative energy supply systems. Environmentally friendly, efficient and individually adapted to local conditions.

## The right system for every capacity

The fundament of our flexible systems is PV energy. Depending upon which additional energy sources are available, small wind turbine systems or hydroelectric power plants

can be integrated into the stand-alone grid – with perfectly matched inverter solutions from a single source.

## Worldwide application

SMA off-grid systems are easy to install, modularly expandable and available worldwide. They are the economical alternative to laborious and expensive diesel systems. Whether it is current for the weekend home, or the supply of entire villages and islands: our products electrify rural regions and provide a reliable electricity supply where power distribution grids are unstable.

## Competent system partners

At SMA, quality is both a product feature and an expression of our daily work. We are your competent system partner – from the very start. In addition, we make energy supply truly sustainable, because we offer people the necessary conditions to develop their economic power locally. Everywhere.



## Self-sufficient energy supply with a hybrid system – a solution example

- 1 Sunny Island**  
Robust and flexible. Sunny Island is a grid and battery manager that controls the off-grid system.
- 2 Multiclustor Box**  
Modular. Off-grid systems with up to 300 kilowatts can be quickly and easily realized with the fully preconfigured AC distribution board.
- 3 Windy Boy**  
All-purpose. The inverter converts direct current from water or wind power plants into grid-compliant alternating current.
- 4 System buildings**  
Centralized. This is where you'll find the off-grid inverter, the batteries for intermediate storage and the Multiclustor Box.
- 5 Wind turbine system**  
Complementary. Depending on the site, the integration of wind turbine systems can be an added intelligent energy source.
- 6 Hydroelectric power plant**  
Fluid. New or existing hydroelectric power plants are a smart addition to the off-grid system.
- 7 Sunny Boy**  
Reliable. The PV inverter converts the solar energy and stores it in the system.
- 8 Solar electricity generator**  
Direct. The PV module produces power precisely where it is needed. In many locations, solar and wind energy complement each other perfectly through the seasons.
- 9 Diesel generator**  
Failsafe. A generator provides backup power during long periods of drought, calm winds, or low solar radiation.



Plant design and simulation  
made easy:  
[www.SMA.de/OffGridConfigurator](http://www.SMA.de/OffGridConfigurator)





# Off-grid solutions

## Compatible products

From planning to installation to commissioning: products which are optimally matched perfect stand-alone energy supply for all power classes from 1 to 300 kilowatts. Whether it is sun, wind or water, Sunny Island assumes the entire load, energy and battery management, ensuring reliable operation at all times. The best part: if energy demand increases, the stand-alone grid grows with it, thanks to the modular system technology.

### ■ OFF-GRID INVERTERS



Sunny Island 4548-US  
Sunny Island 6048-US  
Sunny Island 5048



Sunny Island 2012  
Sunny Island 2224



Sunny Remote Control



Smartformer



Sunny Island Charger 50



Multicluster-Box 6  
Multicluster-Box 12  
Multicluster-Box 36



Smart Load

### ■ Compatible products from Chapter "WIND POWER INVERTERS"



WB 5000A  
WB 6000A  
WB 5000-US  
WB 6000-US  
WB 7000-US  
WB 8000-US



WB 3600TL  
WB 5000TL



WB 3300  
WB 3800  
WB 3000-US  
WB 3800-US  
WB 4000-US



WB 2500  
WB 3000



WB 1200  
WB 1700



WB Protection Box

■ Compatible products from the Chapter "INVERTERS WITH/WITHOUT TRANSFORMERS"



STP 15000TLHE-10  
STP 20000TLHE-10



STP 10000TL-10  
STP 12000TL-10  
STP 15000TL-10  
STP 17000TL-10



SMC 9000TL-10  
SMC 10000TL-10  
SMC 11000TL-10  
SMC 9000TLRP-10  
SMC 10000TLRP-10  
SMC 11000TLRP-10  
SMC 7000HV-11  
SMC 4600A-11  
SMC 5000A-11  
SMC 6000A-11



SB 6000TLUS-12  
SB 7000TLUS-12  
SB 8000TLUS-12  
SB 9000TLUS-12  
SB 10000TLUS-12  
SB 11000TLUS-12  
SB 5000-US-12  
SB 6000-US-12  
SB 6000 US  
SB 7000-US-12  
SB 7000 US  
SB 8000-US-12  
SB 8000US



SB 3000TL-21  
SB 3600TL-21  
SB 4000TL-21  
SB 5000TL-21



SB 3000US  
SB 3000-US-12  
SB 3800-US-10  
SB 3800-US-12  
SB 4000US  
SB 4000-US-12



SB 2000HF-30  
SB 2500HF-30  
SB 3000HF-30



SB 2000HFUS-30  
SB 2500HFUS-30  
SB 3000HFUS-30



SB 1600TL-10  
SB 2100TL

■ Compatible products from the Chapter "MONITORING SYSTEMS"



Sunny WebBox



Sunny Portal



Sunny SensorBox



SMA Off-Grid  
Configurator

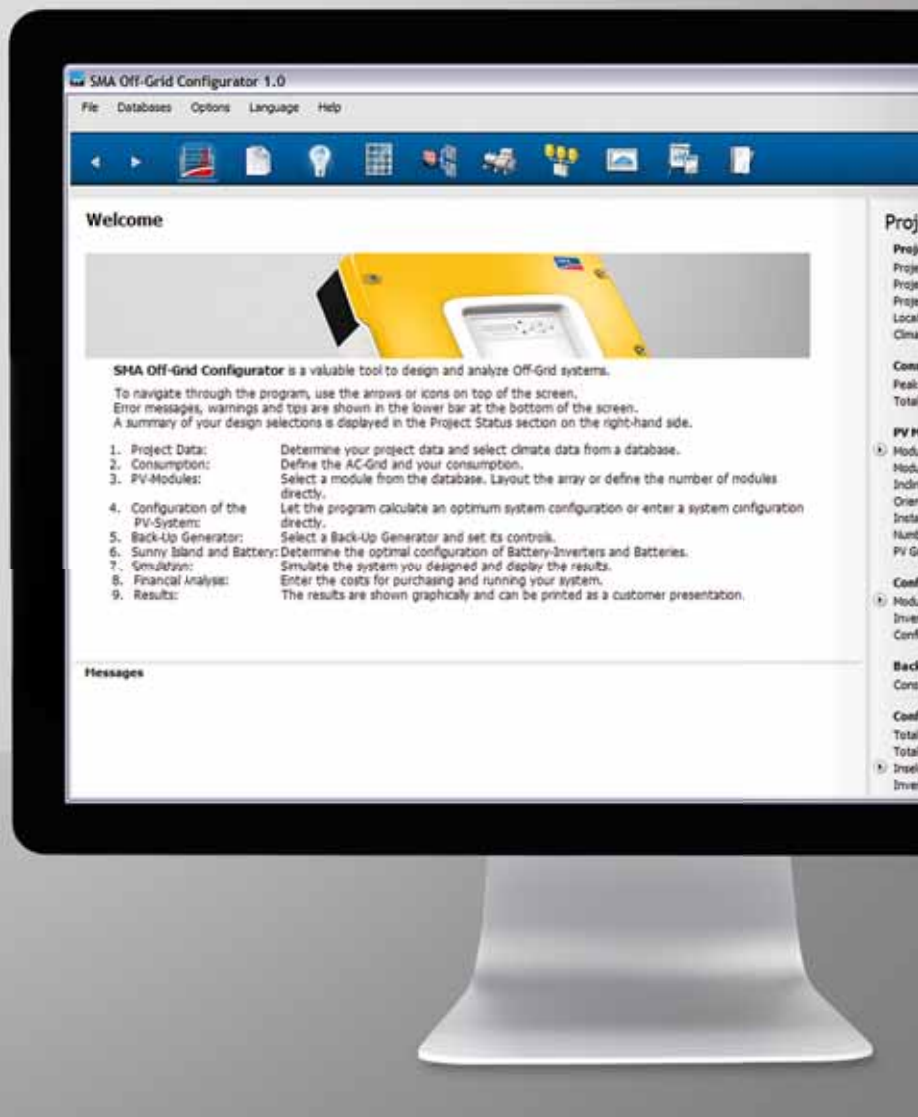

### Simple

- Intuitive operation
- Results are presented in an easy-to-read format
- Results in 9 steps

### Unique

- Calculation of battery life
- Load- and charge-dependent generator start
- Calculation of diesel consumption

### Professional

- Calculating profitability
- Comprehensive component data bank
- Simulation of the entire system

### Globally

- Suitable for all system constellations, locations and climate data
- Simulation of 120 V/230 V systems



## SMA OFF-GRID CONFIGURATOR

Design and simulation program for off-grid systems

Plant design for off-grid systems can be cumbersome and time consuming. With the new Off-Grid Configurator, SMA offers a professional and individual solution for the dimensioning and simulation of your off-grid plant – whether it is a small system or a large hybrid plant. The program displays all aspects of design: dimensioning of your PV plant, of the battery, and inverters as well as profitability calculations and battery life. It also lets you compare different plant sizes so as to determine the optimal system for each location. You save time and money. The Configurator supports SMA off-grid systems all over the world, and both 230 V and 120 V systems.





#### Efficient

- Max. efficiency: > 96 percent
- CEC of 94.5 percent
- Intelligent battery management for maximum battery life
- Charge level calculation

#### Simple

- Easy commissioning with the "Quick Configuration Guide"
- Complete off-grid management

#### Flexible

- For systems from 3 kW to 100 kW
- single and three-phase operation, connectable in parallel and modularly extendable
- AC and DC coupling

#### Durable

- Extreme overload capacity
- OptiCool
- 5-year SMA warranty



## SUNNY ISLAND 4548-US / 6048-US

The efficient island manager: now with 20 percent more power

As the new Sunny Island inverters 4548-US and 6048-US were developed, the special focus was on their efficiency. Expanding on the proven technology of Sunny Island 5048-US, those inverters can reach the maximum efficiency level of over 96 percent as well as a weighted CEC efficiency level of 94.5 percent. This saves diesel costs and enables a smaller dimensioning of PV plants. The new devices for the US market can be used with the SMA multicuster technology for systems with a capacity of up to 100 kW.



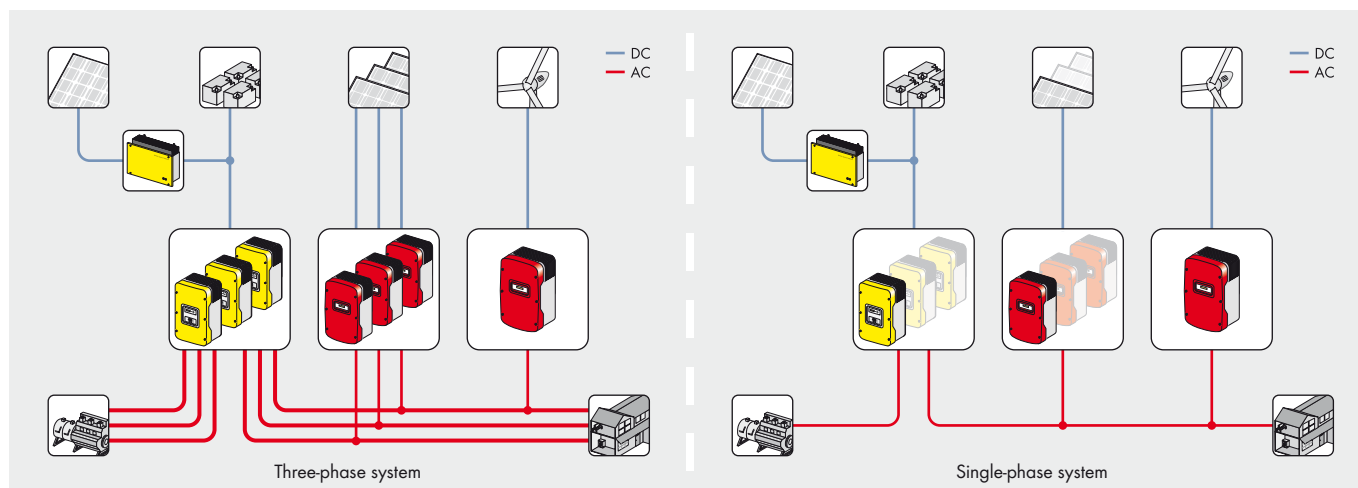

Technical data	Sunny Island 4548-US	Sunny Island 6048-US
<b>AC output (loads)</b>		
Rated grid voltage / AC voltage range	120 V/105 V - 132 V	120 V/105 V - 132 V
Rated frequency / frequency range (adjustable)	60 Hz/55 Hz ... 65 Hz	60 Hz/55 Hz ... 65 Hz
AC power (at 25 °C / at 40 °C) for 3 hours	5000 W/4000 W	6000 W/5000 W
Rated power (@ $U_{nom}$ , $f_{nom}$ / 25 °C / @ $\cos \varphi = 1$ )	4500 W	5750 W
AC power at 25 °C for 30 min / 1 min / 3 s	5300 W / 8400 W / 11000 W	7000 W / 8400 W / 11000 W
Rated current / max. output current (peak)	37.5 A/180 A for approx. 60 ms	48 A/180 A for approx. 60 ms
Total harmonic factor output voltage / power factor with rated power	3 % / -1 ... +1	3 % / -1 ... +1
<b>AC input (PV array or grid)</b>		
Rated input voltage / AC input voltage range	120 V/80 V - 150 V	120 V/80 V - 150 V
Rated input frequency / allowable input frequency range	60 Hz/54 Hz ... 66 Hz	60 Hz/54 Hz ... 66 Hz
Max. AC input current / adjustable	56 A/0 A ... 56 A	56 A/0 A ... 56 A
Max. AC input power	6.7 kW	6.7 kW
<b>Battery DC input</b>		
Rated input voltage / DC voltage range	48 V/41 V - 63 V	48 V/41 V - 63 V
Max. battery charging current / DC rated charging current	100 A / 85 A	130 A / 110 A
Battery type / battery capacity range	Lead, NiCd/100 Ah ... 10000 Ah	Lead, NiCd/100 Ah ... 10000 Ah
Charge control	IUoU charge procedure with automatic full charge and equalization charge	IUoU charge procedure with automatic full charge and equalization charge
<b>Efficiency / self-consumption</b>		
Max. efficiency / CEC efficiency	96 % / 94 %	96 % / 93.5 %
Self-consumption without load / standby	25 W/4 W	25 W/4 W
<b>Protective devices</b>		
DC reverse polarity protection / DC fuse	● / ●	● / ●
AC short-circuit / AC overload	● / ●	● / ●
Overtemperature / battery deep discharge	● / ●	● / ●
<b>General data</b>		
Dimensions (W / H / D)	467 / 612 / 235 mm (18.4 / 24.1 / 9.3 inch)	467 / 612 / 235 mm (18.4 / 24.1 / 9.3 inch)
Weight	63 kg / 139 lb	63 kg / 139 lb
Operating temperature range	-25 °C ... +60 °C / -13 °F ... +122 °F	-25 °C ... +60 °C / -13 °F ... +122 °F
<b>Features / function</b>		
Operation and display / multi-function relay	Internal / 2	Internal / 2
Degree of protection (according to IEC 60529)	indoors (NEMA 1)	indoors (NEMA 1)
Three-phase systems / parallel connection	● / ●	● / ●
Integrated bypass / multicuster operation	- / ●	- / ●
State of charge calculation / full charge / equalization charge	● / ● / ●	● / ● / ●
Integrated soft start / generator support	● / ●	● / ●
Battery temperature sensor / data cable	● / ●	● / ●
Warranty (5 / 10 / 15 / 20 / 25 years)	● / ○ / ○ / ○ / ○	● / ○ / ○ / ○ / ○
Certificates and approvals	www.SMA-Solar.com	www.SMA-Solar.com
<b>Accessories</b>		
Battery cable / battery fuse	○ / ○	○ / ○
Interface (RS 485 / Multicuster PB)	○ / ○	○ / ○
Extended generator start "GenMan"	○	○
Load-shedding protection / battery current measurement	○ / ○	○ / ○
● Standard feature ○ Optional feature - Not available		
Type designation	SI4548-US-10	SI6048-US-10



#### Flexible

- For systems from 3 kW to 300 kW
- Single and three-phase operation, connectable in parallel and modularly extendable
- AC and DC coupling

#### Simple

- Easy commissioning with the "Quick Configuration Guide"
- Complete off-grid management

#### Efficient

- High efficiency
- Intelligent battery management for maximum battery life
- Charge level calculation

#### Durable

- Extreme overload capacity
- OptiCool
- 5-year SMA warranty



## SUNNY ISLAND 5048 / 5048-US

### The island manager

Commissioning just takes a few minutes: For Sunny Island 5048, the settings needed for operation can be configured in very few steps. It is flexible in its application, extendable and takes on all control processes. Its first-class battery management ensures maximum battery life. In addition, the device is highly efficient, has an ergonomic die-cast aluminum enclosure and an OptiCool active cooling system.





#### Flexible

- For systems from 1 kW to 9 kW
- Single and three-phase operation, connectable in parallel and modularly extendable
- AC and DC coupling

#### Simple

- Simple installation
- Complete off-grid management
- Easy and remote configuration and monitoring with Sunny Remote Control

#### Efficient

- High efficiency
- Intelligent battery management for maximum battery life
- Charge level calculation

#### Durable

- For indoor and outdoor installation
- Outstanding overload properties
- Very wide temperature range
- 5-year SMA warranty



## SUNNY ISLAND 2012 / 2224

Compact and powerful for small off-grid systems

Ideal for the lower power range in the SMA product portfolio: The Sunny Island 2012 and 2224 do not only cover all proven characteristics of the Sunny Island 5048. Reduced in weight and volume, the devices are even easier to operate and install. The high IP54 protection class and the Sunny Remote Control service unit ensure maximum flexibility when choosing the site. Easy-to-use technology at the highest level: an unbeatable combination for off-grid systems up to 9 kW.







### Flexible

- Control and visualization unit
- Usable from a distance of up to 20 meters
- Wall mounting or top-hat rail installation

- For systems with Sunny Island 2224/2012, Sunny Island 4.0M/5.4M/6.0H/8.0H and Sunny Backup 2200

### Simple

- Just one cable for power supply and communication
- Intuitive operation via rotary switch
- Just one SRC-20 per cluster

### Communicative

- Four-line display
- SD card as service interface



## SUNNY REMOTE CONTROL

Enhanced flexibility for Sunny Island and Sunny Backup

Systems using Sunny Island and Sunny Backup are now even more flexible: to maximize the user convenience, we have moved the control unit on the outside of the inverter. With the Sunny Remote Control, you can now commission and monitor the devices conveniently without standing right in front of the inverter. The SRC-20 can be used at a distance of up to 20 meters and processes information from up to three devices. The rotary switch allows intuitive operation. The four-line display gives you clearly arranged information on the current plant status at one glance. An SD card serves as the service interface. Another convincing feature is the simplicity of installing the SRC-20. Just one cable is needed for the electrical connection and communication. Plug it in at both ends – and there you are.





#### Simple

- Pre-wired AC distribution board
- Quick installation and commissioning
- Suitable for SI 4548 / 6048-US

#### Complete

- Bypass switch for direct grid operation
- Load-shedding contactor to prevent battery deep discharge
- Miniature circuit-breaker for PV and load

#### Efficient

- Max. efficiency: 99 percent
- Highest yield in the entire power range

#### Secure

- UL listed
- Optimized overload protection
- Warranty: 5 years as standard – extendable to 20 years



## SMARTFORMER for SUNNY ISLAND

Set up split-phase grids – easier than ever

The Smartformer is the complete solution for off-grid and backup plants of up to seven kilowatts. At the same time, it acts as a AC distributor and a 120/240-volt autotransformer. The transformer provides step-up and step-down options to supply loads with 120 V and 240 V using a Sunny Island and a Sunny Boy – with a high level of efficiency over the entire power spectrum. Thanks to the pre-wired bypass function, the PV plant can be bridged without problems via a robust switch for maintenance work. The optimized transformer overload protection and a load-shedding contactor provide extra protection to the system. The Smartformer makes the stand-alone power supply simple and reliable.

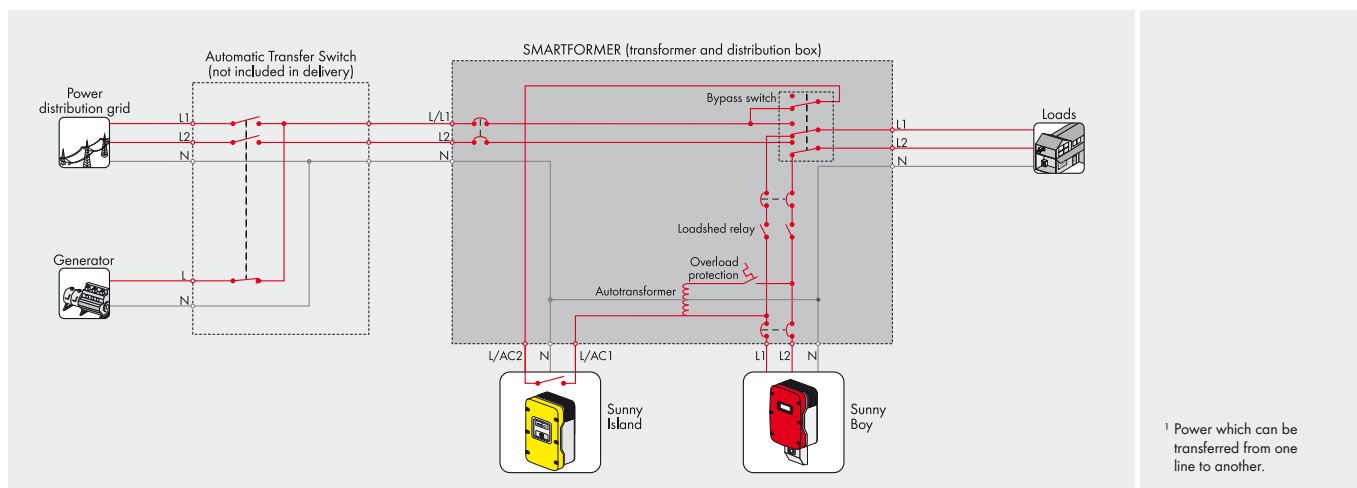

<sup>1</sup> Power which can be transferred from one line to another.

Technical data	Smartformer
<b>General data</b>	
Number of phases	Split-Phase
Rated voltage	120 / 240 Vac
AC voltage range between L1 and N	102 V - 132 V
AC voltage range between L1 and L2	204 V - 264 V
Rated frequency	60 Hz
Dimensions (W / H / D)	610 x 610 x 235 mm
Weight	56 kg
Self-consumption (no-load operation)	19 W
Rated power transformer <sup>1</sup>	3.4 kVA
Max. efficiency / CEC efficiency	99 % / 98.8 %
Transformer AC power for 30 min <sup>1</sup>	4.4 kVA
Transformer AC power for 1 min <sup>1</sup>	8.8 kVA
Hookup access	Knockout top: 2x 3/4", 2x 1", 2x 1 1/4" unten 5x 3/4", 3x 1", 3x 1 1/4"
<b>Connections for Sunny Island</b>	
Max. number and nominal voltage of Sunny Island	1 x 120 V (L1, N)
Rated power	5.8 kW
Current at rated values	48 A
Fuses	1
<b>PV plant connection</b>	
Number of connections / rated voltage	1 x 240 V (L1, L2, N)
Rated power	9.6 kW
AC power in parallel grid operation	6 kW
AC current at rated values	40 A
Fuses	2
<b>Load Connection</b>	
Number of connections / rated voltage	1 x 120/240 V
Rated power	7.2 kW
AC power at 40 °C	6.6 kW
Rated power / current between L1 and L2	6.7 kW / 28 A
Rated power / current between L1 and N	3.8 kW / 32 A
Rated power / current between L2 and N	3.4 kW / 28 A
Current at rated values	32 A, 28 A (with activated bypass: 2 x 48 A)
Fuse	K40A (with activated bypass: K60A)
<b>PV array connection</b>	
Number of connections / rated voltage	120 / 240 V (L1, L2, N)
Rated grid input power	11.5 kW
AC input current	48 A
Fuse	2
<b>Ambient Conditions</b>	
Operating temperature range	-25 °C ... +60 °C
Humidity	0 - 100 % (non-condensing)
Protection class	NEMA Type 1
Certification and approval	UL 1741
<b>Features / function</b>	
Warranty: 5 / 10 / 15 / 20 years	● / ○ / ○ / ○
Integrated bypass for maintenance / load-shedding contactor / transformer protection	● / ● / ●
● Standard feature ○ Optional feature – Not available	
Type designation	SI-TB-BOX-10



#### Flexible

- For 12 / 24 / 48 V
- Up to four devices can be connected in parallel
- Modular and extendable

#### Simple

- Easy installation and commissioning
- Operation and configuration via Sunny Island (Single Point of Operation)

#### Efficient

- Active MPP tracking
- Efficiency > 98 %

#### Durable

- Outdoor installation possible due to IP65
- Without fan
- Nominal power up to 40 °C
- 5-year SMA warranty



## SUNNY ISLAND CHARGER 50

SMA DC connection: maximum efficiency and applicable everywhere

AC and DC coupling in perfect interaction and from a single manufacturer: the all-purpose Sunny Island Charger 50 by SMA. Its broad DC input voltage range makes configuration possible for almost any PV module. Thanks to the integrated MPP tracking system, the charger guarantees an energy yield between 15 to 30 percent higher than that of conventional shunt charge controllers. Unique in charge controllers of this power range: the high protection class, fanless operation and broad temperature range enable its use even under extreme climatic conditions. Easy installation and automatic control through the Sunny Island make commissioning super simple.



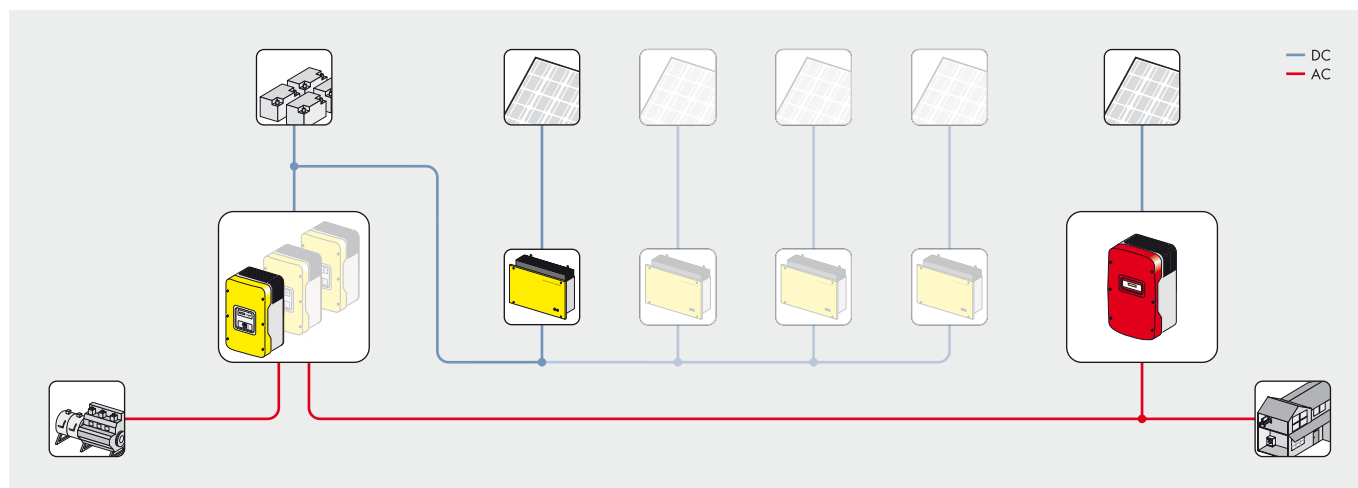

Technical data	Sunny Island Charger 12 V	Sunny Island Charger 24 V	Sunny Island Charger 48 V
<b>Input (PV array)</b>			
Max. DC input power	630 W	1250 W	2400 W
Max. DC input voltage	140 V DC	140 V DC	140 V DC
Optimal MPP tracking voltage range	25 V – 60 V	40 V – 80 V	70 V – 100 V
Number of MPP trackers	1	1	1
Max. DC input current	40 A	40 A	40 A
<b>Output (battery)</b>			
DC rated power up to 40 °C	600 W	1200 W	2400 W
DC Rated voltage	12 V	24 V	48 V
Voltage range	8 V – 15.6 V	16 V – 31.5 V	36 V – 65 V
Battery type	VRLA batteries	VRLA batteries	VRLA batteries
Max. charging current	50 A	50 A	50 A
Rated DC charging current	50 A	50 A	50 A
Charge control	IUoU	IUoU	IUoU
<b>Efficiency</b>			
Max. efficiency	98 %	98 %	98 %
European weighted efficiency	97.3 %	97.3 %	97.3 %
<b>Device protection (PV/Battery)</b>			
DC reverse polarity	●	●	●
Short-circuit current capability	●	●	●
Overload protection	●	●	●
Over- and undervoltage protection	●	●	●
Over- and undertemperature protection	●	●	●
<b>General data</b>			
Dimensions (W / H / D)	421 / 310 / 143 mm	421 / 310 / 143 mm	421 / 310 / 143 mm
Weight	10 kg	10 kg	10 kg
Degree of protection (according to IEC 60529)	IP65	IP65	IP65
Operating temperature range	-25 °C ... +60 °C	-25 °C ... +60 °C	-25 °C ... +60 °C
Humidity	0 % ... 100 %	0 % ... 100 %	0 % ... 100 %
Daytime / nighttime self-consumption	< 5 W / < 3 W	< 5 W / < 3 W	< 5 W / < 3 W
<b>Features / function</b>			
Advertisement	multicolored LEDs	multicolored LEDs	multicolored LEDs
Parameterization	Plug and play in combination with SI 5048, SI2224, SI2012 (Sync Bus Piggy Back required), DIL switch with stand-alone applications	Plug and play in combination with SI 5048, SI2224, SI2012 (Sync Bus Piggy Back required), DIL switch with stand-alone applications	Plug and play in combination with SI 5048, SI2224, SI2012 (Sync Bus Piggy Back required), DIL switch with stand-alone applications
Parallel operation	Up to 4 devices	Up to 4 devices	Up to 4 devices
Communication interface	○	○	○
Battery temperature sensor	○	○	○
Warranty: 5 / 10 / 15 / 20 / 25 years	● / ○ / ○ / ○ / ○	● / ○ / ○ / ○ / ○	● / ○ / ○ / ○ / ○
Certificates and approvals	CE	CE	CE
● Standard feature   ○ Optional feature   – Not available			
Type designation	SIC50-MPT 12 V	SIC50-MPT 24 V	SIC50-MPT 48 V



#### Flexible

- Three different power classes, from 20 kW to 300 kW
- Different array, PV and load sizes

#### Simple

- Integrated AC distribution for Sunny Island, array, PV
- Integrated load-shedding contactor

#### Secure

- Automatic bypass for the PV array
- Active Anti-Islanding
- Reverse current monitoring

#### Durable

- IP65 high protection class
- 5-year SMA warranty



## Multicluster Boxes for SUNNY ISLAND

For easy set-up of stand-alone and hybrid systems

The Multicluster Boxes for Sunny Island 5048 allow the formation of off-grid and hybrid systems with a capacity of between 20 and 300 kW. As the main AC distribution for the connection of generators and for supplying loads of up to 300 kW, between two and 12 three-phase clusters, each consisting of three Sunny Island inverters, can be connected in parallel using the Multicluster Box. To simplify installation, all Multicluster Boxes are completely wired and fitted at the factory and have a main connector for generators, the load distribution and PV or wind turbine systems. All data cables required for the installation are included in the delivery.



Reao, French Polynesia



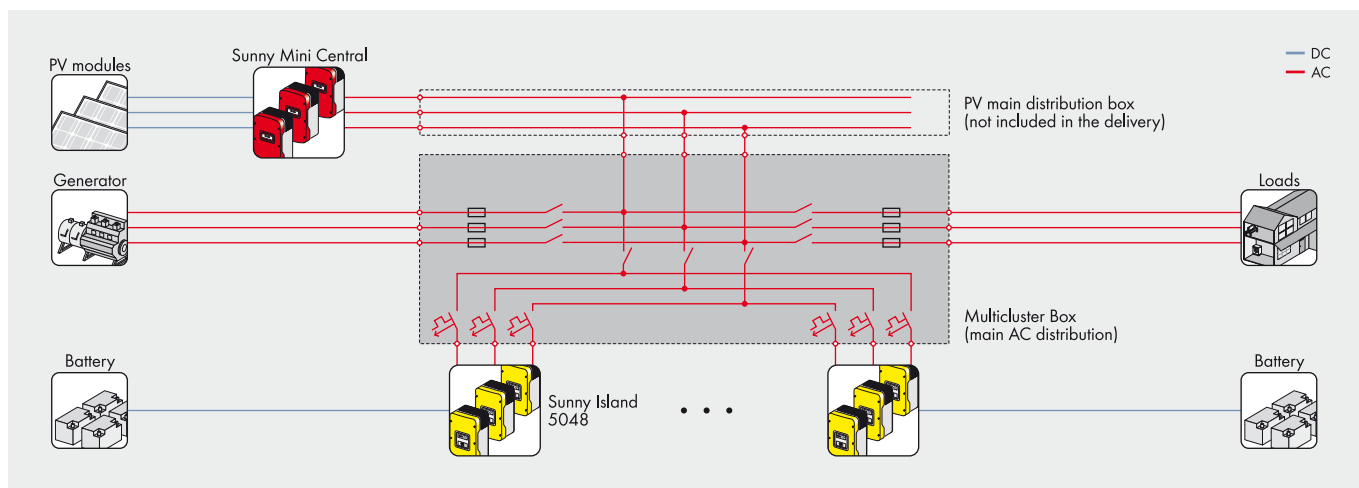

Technical data	SUNNY ISLAND 5048 Multicuster-Box 36	
<b>Load connection</b>		
Rated voltage	230 V (LN), 400 V (L1, L2)	
AC voltage range	172.5 V - 250 V, 300 V - 433 V	
Rated frequency / frequency range	50 Hz / 40 Hz ... 70 Hz	
Quantity	1 (three-phase)	
Rated power	300 kW	
AC current at rated values	3 x 435 A (AC1)	
Fuses	LV/HRC size 3	
<b>Connections for Sunny Island</b>		
Max. number of devices	36	
AC rated power / AC current at rated values	180 kW / 3 x 260 A	
AC power at 45 °C / AC current at 45 °C	144 kW / 3 x 209 A	
AC power (25 °C, 30 min)	234 kW	
AC power (25 °C, 1 min)	300 kW	
Fuses	miniature circuit-breaker C32A	
<b>PV array connection</b>		
Quantity	1 (three-phase)	
Rated grid input power	300 kW	
AC input current	3 x 435 A (AC1)	
Fuses	LV/HRC size 3	
<b>PV plant connection</b>		
Quantity	1 (three-phase)	
PV rated power	300 kW	
AC current at rated values	3 x 435 A (AC1)	
Fuses	–	
<b>General data</b>		
Number of phases	three-phase	
Permitted grid structure	TN	
Dimensions (W / H / D)	1200 / 2000 / 800 mm	
Mounting type	standing on a base	
Weight	400 kg	
Ambient temperature	-25 °C ... +60 °C	
Degree of protection (according to IEC 60529)	IP54	
Max. permissible value for relative humidity (non-condensing)	0 % ... 100 %	
Warranty (5 / 10 / 15 / 20 / 25 years)	● / ○ / ○ / ○ / ○	
Certificates	CE	
Data cables	●	
● Standard feature ○ Optional feature – Not available		
Type designation	MC-Box-36.3	





#### Flexible

- For use from 45 Hz to 65 Hz
- Can be connected in parallel
- Suitable for single and three-phase operation

#### Simple

- Ideal complement for energy sources without active power control
- Easy installation and commissioning

#### Secure

- Minimized AC interference emission thanks to power factor adjustment
- Integrated frequency droop control method

#### Durable

- IP65 high protection class
- 5-year SMA warranty



## Smart Load for SUNNY ISLAND

Intelligent dump load for stand-alone grids

The Smart Load forms the perfect complement to unregulated energy generators in stand-alone grids, e.g. small, directly-connected wind turbine systems with passive stall power control. If there is a surplus of electrical energy, the Smart Load feeds it into special loads, for example heating cartridges in a hot-water tank. This automatic control is extremely fast, non-reactive and offers optimum protection for system components as well as enhanced reliability.







# WIND POWER INVERTERS





# WINDY BOY – Grid connection of small wind turbine systems

Drawing on our experience of over 20 gigawatts of installed inverter power across the world, SMA Solar Technology AG developed the Windy Boy product family as an inverter family for grid connection of small wind turbine systems. With it SMA offers inverters for grid-connected and stand-alone systems, which are suitable for use with small wind turbine systems by different manufacturers and in the power range from 0.5 to 50 kilowatts.

## Multifaceted and high-yielding

High yields can only be achieved when the inverter is ideally suited to the wind turbine's power characteristics. For this reason, SMA has developed programmable polynomial curves for its Windy Boy Inverters. This way the inverters are suitable for use with many turbine types. Since the performance curve of any wind turbine can be depicted with a polynomial, the turbine and the inverter can be optimally adjusted to one another. This allows optimal yields under high or low wind conditions.

The constantly changing slope of the polynomial curve also minimizes mechanical strain on the turbine by gently and gradually shifting the load, even during significant

speed fluctuations. This has a positive effect on the service life of the turbine, and therefore also on its profitability.

## Universally applicable

Windy Boy inverters are designed for worldwide use. They have certifications for all important wind energy markets. The Grid Guard automatic disconnection device and the automatic 50/60 Hz detection simplify the installation effort and the approval process.

## Safe from overload

The Windy Boy Protection Box protects the inverter from overvoltage. It diverts excess energy from the generator into a load resistance, braking the turbines gently. This way the wind turbine system can continue to feed into the electricity grid, even when there is excessive generator voltage. At the same time, the Box provides connections for other permanent-magnet generators, such as hydroelectric power plants or CHP plants.

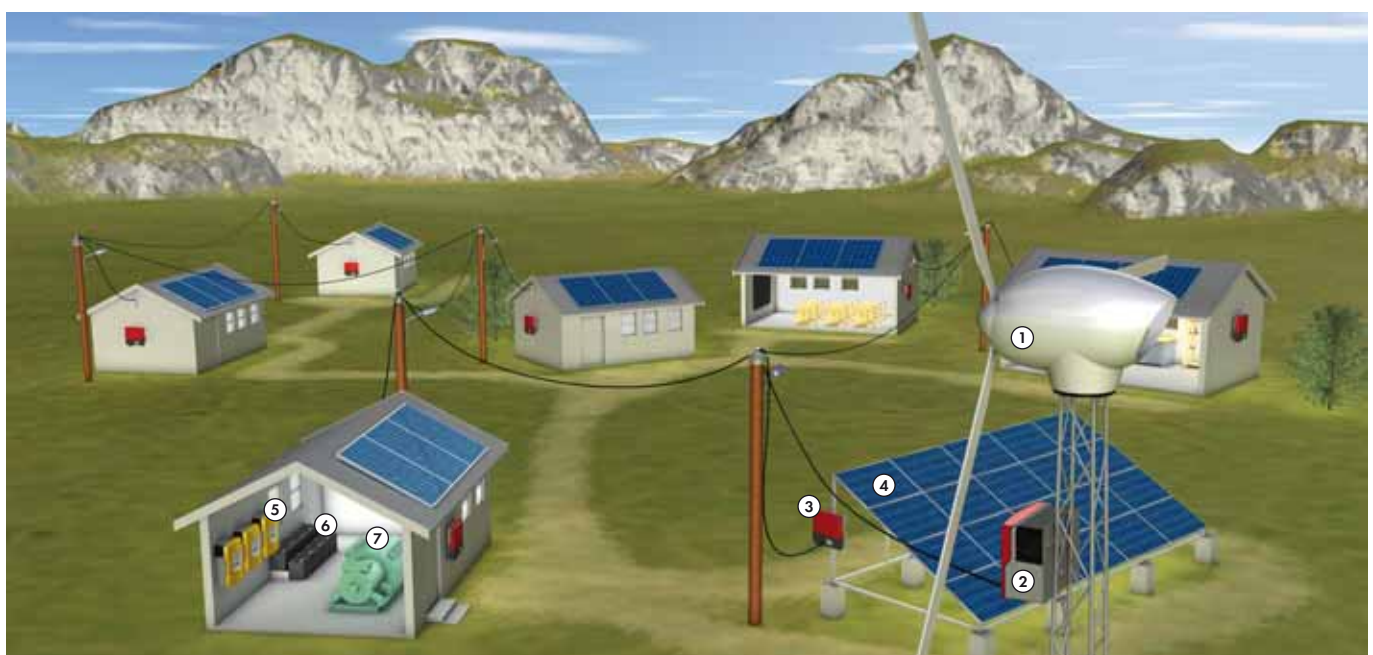

**Components:** 1. Wind turbine system, 2. Windy Boy, 3. Sunny Boy, 4. PV array, 5. Sunny Island, 6. Batteries, 7. Diesel generator





#### Economical

- Up to 96.1% efficiency
- Can be combined to form three-phase units with up to 50 kW output
- Integrated SMA Power Balancer
- OptiCool: Continuous operation even at high temperatures

#### Simple

- Free choice of installation site
- Programmable polynomial curve enables free selection of turbines
- Certified for the most countries (SMA Grid Guard)

#### Secure

- Galvanic isolation
- Compatible with Windy Boy Protection Box 600
- Integrated grid management functions through reactive power provision

#### Reliable

- Worldwide SMA Service including Service Line
- Comprehensive SMA warranty program



## WINDY BOY 5000A / 6000A

The power class up to 50 kW

The Windy Boy 5000A and 6000A feature a peak efficiency of 96.1 percent and are also suited for a three-phase grid feed-in. The integrated SMA Power Balancer prevents undue unbalanced load, and the plant is also able to feed in even if individual line conductors fail. Thanks to the reactive power provision the inverters add to the grid stability and can be used flexibly in plants of different sizes. The weatherproof enclosure and the wide temperature range allow for installation at almost any location. Thanks to OptiCool, the equipment works at outside temperature of up to 45 °C with maximum output.

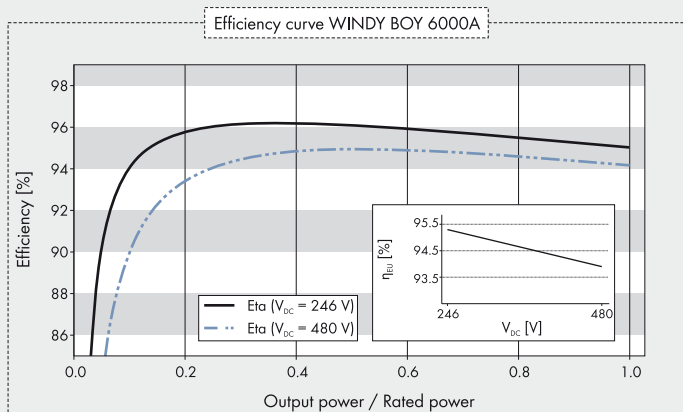

Accessories



RS485 interface  
485PB-NR



Bluetooth  
Piggy-Back BTPBINV-NR



SMA Power Balancer Set  
PBL-SBUS-10-NR



Grounding set "positive"  
ESHV-P-NR



Grounding set "negative"  
ESHV-N-NR

<sup>1</sup> Does not apply to all national appendices of EN 50438

Technical data	Windy Boy 5000A	Windy Boy 6000A
<b>Input (DC)</b>		
Max. DC power (@ cos φ = 1)	5750 W	6300 W
Recommended array power at 2500 / 5000 full-load hours per year	4600 W / 4200 W	5500 W / 5100 W
Max. input voltage / rated input voltage	600 V / 246 V	600 V / 246 V
Min. open-circuit voltage for "Turbine Mode" activation	250 V	250 V
"Turbine Mode" voltage range	246 V - 600 V	246 V - 600 V
Max. input current	26 A	26 A
<b>Output (AC)</b>		
Rated power (@ 230 V, 50 Hz)	5000 W	6000 W
Max. apparent AC power	5500 VA	6000 VA
Nominal AC voltages / range	220 V, 230 V, 240 V / 160 V - 265 V	220 V, 230 V, 240 V / 160 V - 265 V
AC power frequency / range	50 Hz, 60 Hz / -6 Hz ... +5 Hz	50 Hz, 60 Hz / -6 Hz ... +5 Hz
Rated power frequency / rated grid voltage	50 Hz / 230 V	50 Hz / 230 V
Max. output current	26 A	26 A
Power factor at rated power	1	1
Displacement power factor, adjustable	0.8 overexcited ... 0.8 underexcited	0.8 overexcited ... 0.8 underexcited
Feed-in phases / connection phases	1 / 1	1 / 1
Power balancing	●	●
<b>Efficiency</b>		
Max. efficiency / European weighted efficiency	96.1 % / 95.3 %	96.1 % / 95.3 %
<b>Protective devices</b>		
Ground fault monitoring / grid monitoring	● / ●	● / ●
DC reverse polarity protection / AC short-circuit current capability / galvanically isolated	● / ● / ●	● / ● / ●
Protection class (according to IEC 62103) / overvoltage category (according to IEC 60664-1)	I / III	I / III
<b>General data</b>		
Dimensions (W / H / D)	468 / 613 / 242 mm (18.4 / 24.1 / 9.5 inch)	468 / 613 / 242 mm (18.4 / 24.1 / 9.5 inch)
Weight	62 kg / 136.7 lb	63 kg / 139 lb
Operating temperature range	-25 °C ... +60 °C / -13 °F ... +140 °F	-25 °C ... +60 °C / -13 °F ... +140 °F
Noise emission (typical)	42 db(A)	42 db(A)
Topology	LF transformer	LF transformer
Cooling concept	OptiCool	OptiCool
Protection of electronics / connection area (according to IEC 60529)	IP65 / IP65	IP65 / IP65
Climatic category (as per IEC 60721-3-4)	4K4H	4K4H
Max. permissible value for relative humidity (non-condensing)	100 %	100 %
<b>Features</b>		
DC terminal	SUNCLIX	SUNCLIX
AC coupling	Screw terminal	Screw terminal
Display	Text line	Text line
Interfaces: RS485 / Bluetooth	○ / ○	○ / ○
Warranty: 5 / 10 years	● / ○	● / ○
Certificates and approvals (more available upon request)	CE, VDE0126-1-1, G59/2, AS4777, EN 50438 <sup>1</sup> , C10/C11, VDE-AR-N 4105	CE, VDE0126-1-1, G59/2, AS4777, EN 50438 <sup>1</sup> , C10/C11, VDE-AR-N 4105
● Standard feature ○ Optional feature – Not available		
Type designation	WB 5000A-11	WB 6000A-11



#### Reliable

- Max. efficiency of 97 percent
- Transformerless, with H5 topology
- OptiCool: Continuous operation even at high temperatures

#### Flexible

- Broad input voltage range
- Cable connection without tools
- Programmable polynomial curve enables free selection of turbines

#### Simple

- Easily accessible connection area
- Low specific weight

#### Communicative

- Simple country configuration
- *Bluetooth*
- Graphic display



## WINDY BOY 3600TL / 5000TL

Technology meets simplicity

With even better communication, usability and efficiency, the Windy Boy 3600TL and 5000 TL inverters set new standards. With a modern graphic display, a simplified mounting concept and wireless plant communication using the *Bluetooth* global standard, the devices are ideally suited to almost every need. The peak efficiency of 97 percent results in optimal yields from small wind turbine systems. The polynomial curve and broad input voltage range provide maximum plant design flexibility. The new generation Windy Boy: an inverter for all turbine types.

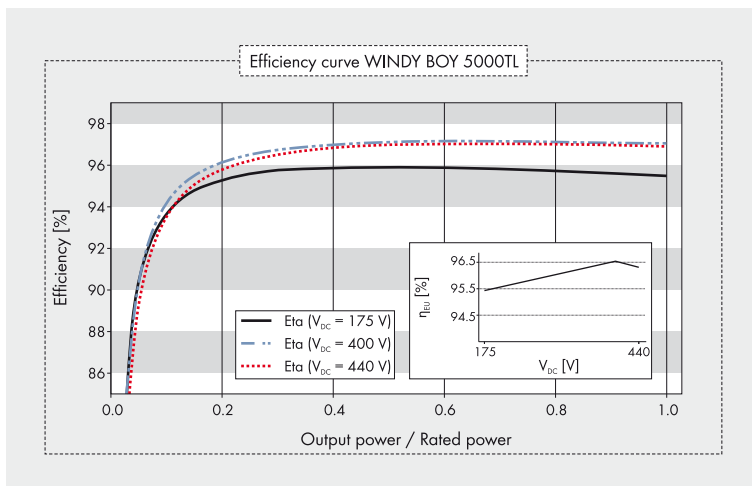

Accessories



RS485 interface  
DM-485CB-10

<sup>1</sup> Does not apply to all national appendices of EN 50438

Technical data	Windy Boy 3600TL	Windy Boy 5000TL
<b>Input (DC)</b>		
Max. DC power (@ cos φ = 1)	3800 W	5300 W
Max. input voltage / rated input voltage	550 V / 400 V	550 V / 400 V
Min. open-circuit voltage for "Turbine Mode" activation	125 V	125 V
"Turbine Mode" voltage range	80 V - 550 V	80 V - 550 V
Max. input current	30 A	30 A
<b>Output (AC)</b>		
Rated power (@ 230 V, 50 Hz)	3600 W	4600 W
Max. apparent AC power	3600 VA	5000 VA
Nominal AC voltages / range	220 V, 230 V, 240 V / 180 V - 280 V	220 V, 230 V, 240 V / 180 V - 280 V
AC power frequency / range	50 Hz, 60 Hz / -5 Hz ... +5 Hz	50 Hz, 60 Hz / -5 Hz ... +5 Hz
Rated power frequency / rated grid voltage	50 Hz / 230 V	50 Hz / 230 V
Max. output current	22 A	22 A
Power factor at rated power	1	1
Feed-in phases / connection phases	1 / 1	1 / 1
<b>Efficiency</b>		
Max. efficiency / European weighted efficiency	97 % / 96.4 %	97 % / 96.5 %
<b>Protective devices</b>		
Ground fault monitoring / grid monitoring	● / ●	● / ●
DC reverse polarity protection / AC short-circuit current capability	● / ●	● / ●
Protection class (according to IEC 62103) / overvoltage category (according to IEC 60664-1)	I / III	I / III
<b>General data</b>		
Dimensions (W / H / D)	470 / 445 / 180 mm (18.5 / 17.5 / 7.1 inch)	470 / 445 / 180 mm (18.5 / 17.5 / 7.1 inch)
Weight	26 kg / 57.3 lb	26 kg / 57.3 lb
Operating temperature range	-25 °C ... +60 °C / -13 °F ... +140 °F	-25 °C ... +60 °C / -13 °F ... +140 °F
Noise emission (typical)	29 db(A)	29 db(A)
Topology	Transformerless	Transformerless
Cooling concept	OptiCool	OptiCool
Protection of electronics / connection area (according to IEC 60529)	IP65 / IP54	IP65 / IP54
Climatic category (according to IEC 60721-3-4)	4K4H	4K4H
Max. permissible value for relative humidity (non-condensing)	100 %	100 %
<b>Features</b>		
DC terminal	SUNCLIX	SUNCLIX
AC coupling	spring clamp terminal	spring clamp terminal
Display	Graphic	Graphic
Interfaces: RS485 / Bluetooth	○ / ●	○ / ●
Warranty: 5 / 10 years	● / ○	● / ○
Certificates and approvals (more available upon request)	CE, VDE0126-1-1, C10/C11, EN 50438 <sup>1</sup>	CE, VDE0126-1-1, G59/2, C10/C11, EN 50438 <sup>1</sup>
● Standard feature ○ Optional feature – Not available		
Type designation	WB 3600TL-20	WB 5000TL-20



#### Economical

- Up to 95.6 % efficiency
- OptiCool: Continuous operation even at high temperatures

#### Simple

- Free choice of installation site
- Programmable polynomial curve enables free selection of turbines
- Certified for the most countries (SMA Grid Guard)

#### Secure

- Galvanic isolation
- Compatible with Windy Boy Protection Box 500
- Integrated grid management functions through reactive power provision

#### Reliable

- Worldwide SMA Service including Service Line
- Comprehensive SMA warranty program



## WINDY BOY 3300 / 3800

Highest yield in any climate

With a maximum efficiency of 95.6 percent, the Windy Boy 3300 and 3800 inverters are among the most cost-effective for small wind turbine systems. The weatherproof enclosure and broad temperature range permit installation at nearly any location, and thanks to the OptiCool cooling system, the inverters operate at outside temperatures of up to 45 °C at maximum output. The programmable polynomial curve enables optimal adaptation to the turbine characteristic curve, thus increasing yield. The inverter can supply reactive power, contributing significantly to grid stability.







#### Economical

- Up to 95 percent efficiency
- Improved yields via polynomial curves

#### Simple

- Free choice of installation site
- Certified for the most countries (SMA Grid Guard)

#### Secure

- Galvanic isolation
- Compatible with Windy Boy Protection Box 600

#### Reliable

- Worldwide SMA Service including Service Line
- Comprehensive SMA warranty program



## WINDY BOY 2500 / 3000

Worldwide proven technology

Windy Boy 2500 and 3000 inverters are ideally suited to small wind turbine systems, and feature a maximum efficiency of 95 percent. The programmable polynomial curve enables an optimal adjustment to the turbine characteristic curve, which is also protected by a special soft start device. This Windy Boy also features the SMA Grid Guard interface, which can be used anywhere in the world. It ensures maximum wind turbine system reliability and allows for the feed-in to almost any power distribution grid.

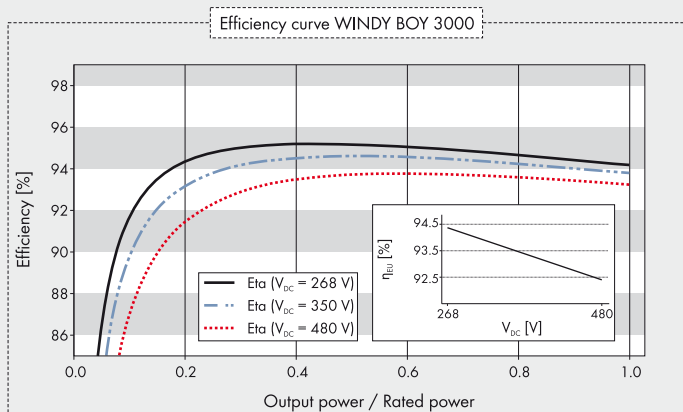

Accessories



RS485 interface  
485USPB-NR



Bluetooth  
Piggy-Back BTPBINV-NR



Grounding set "positive"  
ESHV-P-NR



Grounding set "negative"  
ESHV-N-NR

<sup>1</sup> Does not apply to all national appendices of EN 50438

Technical data	Windy Boy 2500	Windy Boy 3000
<b>Input (DC)</b>		
Max. DC power (@ cos φ = 1)	2700 W	3200 W
Recommended array power at 2500 / 5000 full-load hours per year	2100 W / 1900 W	2500 W / 2200 W
Max. input voltage / rated input voltage	600 V / 300 V	600 V / 350 V
Min. open-circuit voltage for "Turbine Mode" activation	250 V	290 V
"Turbine Mode" voltage range	224 V - 600 V	268 V - 600 V
Max. input current	12 A	12 A
<b>Output (AC)</b>		
Rated power (@ 230 V, 50 Hz)	2300 W	2750 W
Max. apparent AC power	2500 VA	3000 VA
Nominal AC voltages / range	220 V, 230 V, 240 V / 180 V - 265 V	220 V, 230 V, 240 V / 180 V - 265 V
AC power frequency / range	50 Hz, 60 Hz / -4.5 Hz ... +4.5 Hz	50 Hz, 60 Hz / -4.5 Hz ... +4.5 Hz
Rated power frequency / rated grid voltage	50 Hz / 230 V	50 Hz / 230 V
Max. output current	12.5 A	15 A
Power factor at rated power	1	1
Feed-in phases / connection phases	1 / 1	1 / 1
<b>Efficiency</b>		
Max. efficiency / European weighted efficiency	94.1 % / 93.2 %	95 % / 93.6 %
<b>Protective devices</b>		
Ground fault monitoring / grid monitoring	● / ●	● / ●
DC reverse polarity protection / AC short-circuit current capability / galvanically isolated	● / ● / ●	● / ● / ●
Protection class (according to IEC 62103) / overvoltage category (according to IEC 60664-1)	I / III	I / III
<b>General data</b>		
Dimensions (W / H / D)	440 / 339 / 214 mm (17.3 / 13.3 / 8.4 inch)	440 / 339 / 214 mm (17.3 / 13.3 / 8.4 inch)
Weight	28 kg / 61.7 lb	31 kg / 70.5 lb
Operating temperature range	-25 °C ... +60 °C / -13 °F ... +140 °F	-25 °C ... +60 °C / -13 °F ... +140 °F
Noise emission (typical)	33 db(A)	30 db(A)
Topology	LF transformer	LF transformer
Cooling concept	Convection	Convection
Protection of electronics / connection area (according to IEC 60529)	IP65 / IP65	IP65 / IP65
Climatic category (according to IEC 60721-3-4)	4K4H	4K4H
Max. permissible value for relative humidity (non-condensing)	100 %	100 %
<b>Features</b>		
DC terminal	SUNCLIX	SUNCLIX
AC connection	Connector	Connector
Display	Text line	Text line
Interfaces: RS485 / Bluetooth	○ / ○	○ / ○
Warranty: 5 / 10 years	● / ○	● / ○
Certificates and approvals (more available upon request)	CE, VDE0126-1-1, G83/1-1, AS4777, EN 50438 <sup>1</sup> , C10/C11, VDE-AR-N 4105	CE, VDE0126-1-1, G83/1-1, AS4777, EN 50438 <sup>1</sup> , C10/C11, VDE-AR-N 4105
● Standard feature ○ Optional feature – Not available		
Type designation	WB 2500	WB 3000



#### Economical

- Specially designed for small wind energy plants
- Improved yields via polynomial curves

#### Simple

- Free choice of installation site
- Certified for the most countries (SMA Grid Guard)

#### Secure

- Galvanic isolation
- Compatible with Windy Boy Protection Box 400

#### Flexible

- Broad input voltage range for Windy Boy 1200



## WINDY BOY 1200 / 1700

The powerful compact devices

Ideal for small wind turbine systems: The programmable polynomial curve of the Windy Boy 1200 and 1700 inverters allows optimal adjustment to the turbine characteristic curve and thus increases the yield. The weather-proof enclosure and the wide temperature range allow for installation at almost any location. The devices are optimally adjusted to fast and frequent load changes and, with the Windy Boy Protection Box, provide the perfect interface for any turbine. Using the integrated display and different communication interfaces you can monitor all plant values at any time.

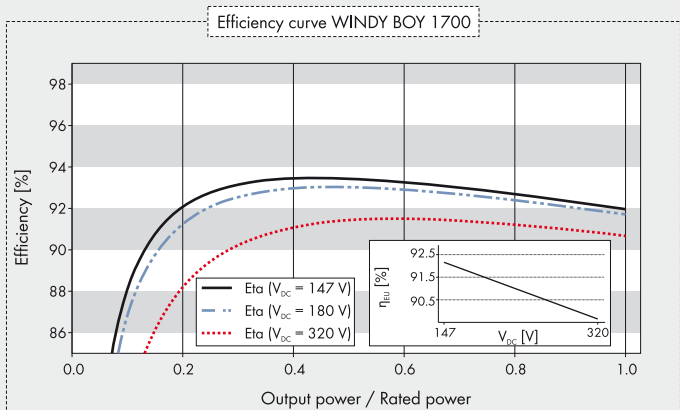

Accessories



RS485 interface  
485USPB-NR



Bluetooth  
Piggy-Back BTPBINV-NR



Grounding set "positive"  
ESHV-P-NR



Grounding set "negative"  
ESHV-N-NR

<sup>1</sup> Does not apply to all national appendices of EN 50438

Technical data	Windy Boy 1200	Windy Boy 1700
<b>Input (DC)</b>		
Max. DC power (@ cos φ = 1)	1320 W	1850 W
Recommended array power at 2500 / 5000 full-load hours per year	1050 W / 1000 W	1400 W / 1300 W
Max. input voltage / rated input voltage	400 V / 120 V	400 V / 180 V
Min. open-circuit voltage for "Turbine Mode" activation	110 V	150 V
"Turbine Mode" voltage range	100 V - 400 V	139 V - 400 V
Max. input current	12.6 A	12.6 A
<b>Output (AC)</b>		
Rated power (@ 230 V, 50 Hz)	1200 W	1550 W
Max. apparent AC power	1200 VA	1700 VA
Nominal AC voltages / range	220 V, 230 V, 240 V / 180 V - 265 V	220 V, 230 V, 240 V / 180 V - 265 V
AC power frequency / range	50 Hz, 60 Hz / -4.5 Hz ... +4.5 Hz	50 Hz, 60 Hz / -4.5 Hz ... +4.5 Hz
Rated power frequency / rated grid voltage	50 Hz / 230 V	50 Hz / 230 V
Max. output current	6.1 A	8.6 A
Power factor at rated power	1	1
Feed-in phases / connection phases	1 / 1	1 / 1
<b>Efficiency</b>		
Max. efficiency / European weighted efficiency	92.1 % / 90.8 %	93.5 % / 91.7 %
<b>Protective devices</b>		
Ground fault monitoring / grid monitoring	● / ●	● / ●
DC reverse polarity protection / AC short-circuit current capability / galvanically isolated	● / ● / ●	● / ● / ●
Protection class (according to IEC 62103) / overvoltage category (according to IEC 60664-1)	I / III	I / III
<b>General data</b>		
Dimensions (W / H / D)	440 / 339 / 214 mm (17.3 / 13.3 / 8.4 inch)	440 / 339 / 214 mm (17.3 / 13.3 / 8.4 inch)
Weight	25 kg / 55.1 lb	25 kg / 55.1 lb
Operating temperature range	-25 °C ... +60 °C / -13 °F ... +140 °F	-25 °C ... +60 °C / -13 °F ... +140 °F
Noise emission (typical)	46 db(A)	46 db(A)
Topology	LF transformer	LF transformer
Cooling concept	Convection	Convection
Protection of electronics / connection area (according to IEC 60529)	IP65 / IP65	IP65 / IP65
Climatic category (according to IEC 60721-3-4)	4K4H	4K4H
Max. permissible value for relative humidity (non-condensing)	100 %	100 %
<b>Features</b>		
DC terminal	SUNCLIX	SUNCLIX
AC connection	Connector	Connector
Display	Text line	Text line
Interfaces: RS485 / Bluetooth	○ / ○	○ / ○
Warranty: 5 / 10 years	● / ○	● / ○
Certificates and approvals (more available upon request)	CE, VDE0126-1-1, G83/1-1, AS4777, C10/C11, VDE-AR-N 4105, EN 50438 <sup>1</sup>	CE, VDE0126-1-1, G83/1-1, AS4777, EN 50438 <sup>1</sup> , C10/C11, VDE-AR-N 4105
● Standard feature ○ Optional feature – Not available		
Type designation	WB 1200	WB 1700





#### UL listed

- For the North American small wind market (UL 1741/IEEE-1547)

#### Reliable

- Peak efficiency of 97 %
- OptiCool active temperature management

#### Simple

- Free choice of installation site
- Programmable polynomial curve enables free selection of turbines

#### Secure

- Galvanic isolation due to integrated transformer
- Compatible with Windy Boy Protection Box 600



## WINDY BOY 5000-US / 6000-US / 7000-US / 8000-US

Versatile performer with UL listing

The Windy Boy inverters with UL listing have a first-rate efficiency level. They are easy to combine since multiple devices can be operated on a single generator. Thus, plants generating more power can be readily connected to the power distribution grid. In addition, the automatic grid voltage detection<sup>1</sup> allows for a straightforward and secure installation. The galvanic isolation also ensures safety as well as flexible connection options. The weatherproof enclosure and the wide temperature range allow for installation at almost any location. These units are the best choice for small wind plants over 4 kW.

<sup>1</sup> US patent US7352549B1



# WINDY BOY 5000-US / 6000-US / 7000-US / 8000-US

Technical data	Windy Boy 6000-US 208 V	Windy Boy 6000-US 240 V	Windy Boy 6000-US 277 V
<b>Input (DC)</b>			
Max. DC power (@ $\cos \varphi = 1$ )	6350 W	6350 W	6350 W
Max. input voltage / rated input voltage	600 V / 310 V	600 V / 310 V	600 V / 310 V
Min. open-circuit voltage for "Turbine Mode" activation	300 V	300 V	300 V
"Turbine Mode" voltage range	250 V - 600 V	250 V - 600 V	250 V - 600 V
Max. input current	25 A	25 A	25 A
<b>Output (AC)</b>			
Rated power (@ 230 V, 50 Hz)	6000 W	6000 W	6000 W
Max. apparent AC power	6100 VA	6100 VA	6100 VA
Nominal AC voltage / range	208 V / 183 V - 229 V	240 V / 211 V - 264 V	277 V / 244 V - 305 V
AC power frequency / range	60 Hz / 59.3 Hz ... 60.5 Hz	60 Hz / 59.3 Hz ... 60.5 Hz	60 Hz / 59.3 Hz ... 60.5 Hz
Rated power frequency / rated grid voltage	60 Hz / 208 V	60 Hz / 240 V	60 Hz / 277 V
Max. output current	33.3 A	28.9 A	25 A
Power factor at rated power	1	1	1
Feed-in phases / connection phases	1 / 2	1 / 2	1 / 1
<b>Efficiency</b>			
Max. efficiency/CEC efficiency	97 % / 95.5 %	97 % / 95.5 %	97 % / 96 %
<b>Protective devices</b>			
DC reverse polarity protection / AC short-circuit current capability / galvanically isolated	● / ● / ●	● / ● / ●	● / ● / ●
Protection class (according to IEC 62103)	I	I	I
Overvoltage category (according to IEC 60664-1)	III	III	III
<b>General data</b>			
Dimensions (W / H / D)	468 / 613 / 242 mm (18.5 / 24 / 9 inch)	468 / 613 / 242 mm (18.5 / 24 / 9 inch)	468 / 613 / 242 mm (18.5 / 24 / 9 inch)
Weight	64 kg / 141 lb	64 kg / 141 lb	64 kg / 141 lb
Operating temperature range	-25 °C ... +45 °C / -13 °F ... +113 °F	-25 °C ... +45 °C / -13 °F ... +113 °F	-25 °C ... +45 °C / -13 °F ... +113 °F
Noise emission	45 db(A)	45 db(A)	45 db(A)
Topology	LF transformer	LF transformer	LF transformer
Cooling concept	OptiCool	OptiCool	OptiCool
Protection of electronics / connection area (according to IEC 60529)	NEMA 3R / NEMA 3R	NEMA 3R / NEMA 3R	NEMA 3R / NEMA 3R
<b>Features</b>			
Display	Text line	Text line	Text line
Interfaces: RS485 / Bluetooth	○ / ○	○ / ○	○ / ○
Warranty: 10 years	●	●	●
Certificates and approvals (more available upon request)	UL1741, UL1998, IEEE 1547, FCC Part 15 (Class A & B)	UL1741, UL1998, IEEE 1547, FCC Part 15 (Class A & B)	UL1741, UL1998, IEEE 1547, FCC Part 15 (Class A & B)
● Standard feature ○ Optional feature – Not available			
Type designation	WB 6000US	WB 6000US	WB 6000US

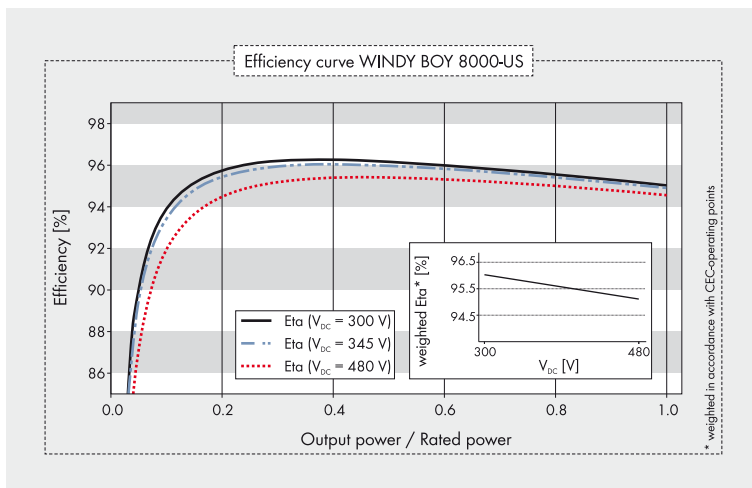

Accessories



RS485 interface  
485USPB-NR



Bluetooth  
Piggy-Back BTPBINV-NR



SMA Power Balancer Set  
PBL-SBUS-10-NR

Data at nominal conditions

Windy Boy 7000-US 208 V	Windy Boy 7000-US 240 V	Windy Boy 7000-US 277 V	Windy Boy 8000-US 240 V	Windy Boy 8000-US 277 V
7400 W	7400 W	7400 W	8600 W	8600 W
600 V / 310 V	600 V / 310 V	600 V / 310 V	600 V / 345 V	600 V / 345 V
300 V	300 V	300 V	365 V	365 V
250 V - 600 V	250 V - 600 V	250 V - 600 V	300 V - 600 V	300 V - 600 V
30 A	30 A	30 A	30 A	30 A
7000 W	7000 W	7000 W	7680 W	8000 W
7100 VA	7100 VA	7100 VA	7680 VA	8100 VA
208 V / 183 V - 229 V	240 V / 211 V - 264 V	277 V / 244 V - 305 V	240 V / 211 V - 264 V	277 V / 244 V - 305 V
60 Hz / 59.3 Hz ... 60.5 Hz	60 Hz / 59.3 Hz ... 60.5 Hz	60 Hz / 59.3 Hz ... 60.5 Hz	60 Hz / 59.3 Hz ... 60.5 Hz	60 Hz / 59.3 Hz ... 60.5 Hz
60 Hz / 208 V	60 Hz / 240 V	60 Hz / 277 V	60 Hz / 240 V	60 Hz / 277 V
34 A	34 A	32 A	32 A	32 A
1	1	1	1	1
1 / 2	1 / 2	1 / 1	1 / 2	1 / 1
97.1 % / 95.5 %	96.9 % / 96 %	97.1 % / 96 %	96.3 % / 96 %	96.5 % / 96 %
● / ● / ●	● / ● / ●	● / ● / ●	● / ● / ●	● / ● / ●
I	I	I	I	I
III	III	III	III	III
468 / 613 / 242 mm (18.5 / 24 / 9 inch)	468 / 613 / 242 mm (18.5 / 24 / 9 inch)	468 / 613 / 242 mm (18.5 / 24 / 9 inch)	468 / 613 / 242 mm (18.5 / 24 / 9 inch)	468 / 613 / 242 mm (18.5 / 24 / 9 inch)
64 kg / 141 lb	64 kg / 141 lb	64 kg / 141 lb	69 kg / 152 lb	69 kg / 152 lb
-25 °C ... +45 °C / -13 °F ... +113 °F	-25 °C ... +45 °C / -13 °F ... +113 °F	-25 °C ... +45 °C / -13 °F ... +113 °F	-25 °C ... +45 °C / -13 °F ... +113 °F	-25 °C ... +45 °C / -13 °F ... +113 °F
46 db(A)	46 db(A)	46 db(A)	49 db(A)	49 db(A)
LF transformer	LF transformer	LF transformer	LF transformer	LF transformer
OptiCool	OptiCool	OptiCool	OptiCool	OptiCool
NEMA 3R / NEMA 3R	NEMA 3R / NEMA 3R	NEMA 3R / NEMA 3R	NEMA 3R / NEMA 3R	NEMA 3R / NEMA 3R
Text line	Text line	Text line	Text line	Text line
○ / ○	○ / ○	○ / ○	○ / ○	○ / ○
●	●	●	●	●
UL1741, UL1998, IEEE 1547, FCC Part 15 (Class A & B)	UL1741, UL1998, IEEE 1547, FCC Part 15 (Class A & B)	UL1741, UL1998, IEEE 1547, FCC Part 15 (Class A & B)	UL1741, UL1998, IEEE 1547, FCC Part 15 (Class A & B)	UL1741, UL1998, IEEE 1547, FCC Part 15 (Class A & B)
WB 7000US	WB 7000US	WB 7000US	WB 8000US	WB 8000US



#### UL listed

- For the North American small wind market (UL 1741/IEEE-1547)

#### Economical

- Peak efficiency of 96.5 %
- OptiCool active temperature management

#### Simple

- Free choice of installation site
- Programmable polynomial curve enables free selection of turbines

#### Secure

- Galvanic isolation due to integrated transformer



## WINDY BOY 3000-US / 3800-US / 4000-US

A reliable option with UL listing

User-friendly, safe and reliable: the Windy Boys in the 3000, 3800 and 4000 watt power classes are specially certified for the US market. The automatic grid voltage detection<sup>1</sup> allows for a straightforward and secure installation. The programmable polynomial curve offers the greatest freedom of turbine choice. The aluminum die-cast enclosure and the OptiCool active cooling system ensure optimal yield as well as a long service life, even under adverse operating conditions.

<sup>1</sup> US-Patent US7352549B1



Source above: STEP Energysystems GmbH, Austria / Source below: Braun Windturbinen GmbH, Germany





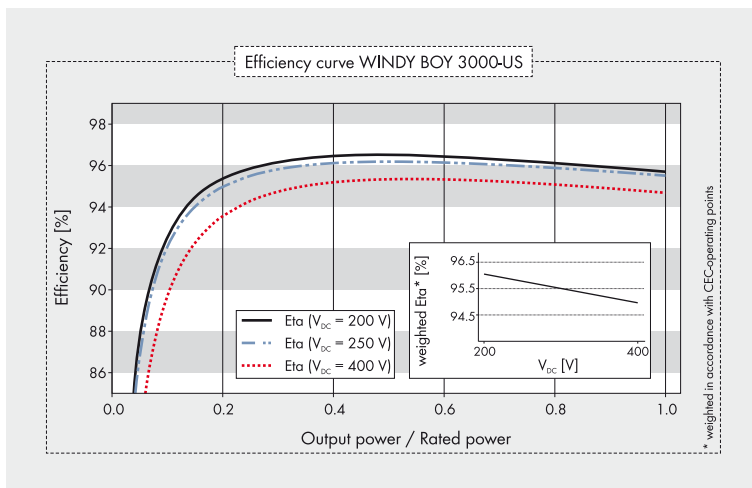

**Accessories**



RS485 interface  
485USPB-NR



Bluetooth  
Piggy-Back BTPBINV-NR

Data at nominal conditions

Technical data	Windy Boy 3800-US 240 V	Windy Boy 4000-US 208 V	Windy Boy 4000-US 240 V
<b>Input (DC)</b>			
Max. DC power (@ $\cos \varphi = 1$ )	4200 W	4200 W	
Max. input voltage / rated input voltage	600 V / 310 V	600 V / 310 V	
Min. open-circuit voltage for "Turbine Mode" activation	285 V	285 V	
"Turbine Mode" voltage range	250 V - 600 V	220 V - 600 V	250 V - 600 V
Max. input current	18 A	18 A	
<b>Output (AC)</b>			
Rated power (@ 230 V, 50 Hz)	3800 W	3500 W	4000 W
Max. apparent AC power	3800 W	3500 W	4000 W
Nominal AC voltage / range	240 V / 211 V - 264 V	208 V / 183 V - 229 V	240 V / 211 V - 264 V
AC power frequency / range	60 Hz / 59.3 Hz ... 60.5 Hz	60 Hz / 59.3 Hz ... 60.5 Hz	
Rated power frequency / rated grid voltage	60 Hz / 240 V	60 Hz / 208 V	
Max. output current	16 A	17 A	
Power factor at rated power	1	1	
Feed-in phases / connection phases	1 / 1	1 / 2	
<b>Efficiency</b>			
Max. efficiency / CEC efficiency	96.8 % / 96 %	96.5 % / 95.5 %	96.8 % / 96 %
<b>Protective devices</b>			
DC reverse polarity protection / AC short-circuit current capability	● / ●	● / ●	
Galvanically isolated	●	●	
Protection class (according to IEC 62103)	I	I	
Overvoltage category (according to IEC 60664-1)	III	III	
<b>General data</b>			
Dimensions (W/H/D)	450 / 352 / 236 mm (17.7 / 13.9 / 9.3 inches)		
Weight	40 kg / 88 lb		
Operating temperature range	-25 °C ... +45 °C / -13 °F ... +113 °F		
Noise emission	37 db(A)		
Topology	LF transformer		
Cooling concept	OptiCool		
Protection of electronics / connection area (according to IEC 60529)	NEMA 3R / NEMA 3R		
<b>Features</b>			
Display	Text line		
Interfaces: RS485 / Bluetooth	○ / ○		
Warranty: 10 years	●		
Certificates and approvals (more available upon request)	UL1741, UL1998, IEEE 1547, FCC Part 15 (Class A & B)		
<p>● Standard feature   ○ Optional feature   – Not available</p>			
Type designation	WB 3800-US-10	WB 4000US	



#### Secure

- Highly dynamic overvoltage protection
- Optimal start-up performance of the wind turbine

#### Reliable

- High efficiency of the integrated inverter
- Feed-in-in even at excessive array voltage

#### Easy to use

- Easy installation
- Three-phase array connection
- Available in three voltage classes: 400 V, 500 V and 600 V



## WINDY BOY PROTECTION BOX

Optimal overvoltage protection for your inverter

The Windy Boy Protection Box can do it all: It protects the inverter from excess voltage by feeding excess generator voltage to a load resistance, which slows down the turbine. In addition, the Box features a three-phase rectifier. It is delivered as a turnkey unit and can be used with nearly all types of arrays made by different manufacturers in various power classes. The box is thus suited for use with wind plants as well as for other permanent magnet generators such as small water power plants and CHP systems.



Eigg Island (courtesy of Wind & Sun Ltd.)









#### Customer-oriented

- Professional commissioning and repair
- Telephone support through our SMA Service Line

#### Optimum availability

- Fast and simple device replacement
- One-year full warranty on every replacement device

#### System-stabilizing

- Five-year warranty on all Sunny Island products, PV and wind power inverters

#### Flexible

- Extended warranty (10, 15, 20, or 25 years)
- Choice between two warranty-extension variants

## SMA Service for off-grid system solutions

Support even in remote regions

Off-grid systems are operated in off-grid regions. Because these places are often difficult to reach, remote plants require long-lasting devices that are easy to maintain and to operate. Along with the most important components for a stand-alone grid, such as off-grid, PV or wind power inverters, SMA also offers professional service should problems arise, all from one source. Whether it's the SMA Service Line, support during commissioning or the SMA replacement device: our services are individually tailored to the needs of solar power professionals – worldwide.

### **The SMA replacement device to ensure high availability**

We respond to service requests quickly and efficiently: we ship a replacement inverter with all the necessary updates so the solar power professional can carry out the replacement easily.

If a device is replaced within the warranty period, the remaining warranty period carries over to the replacement device. In any event, we provide a full one-year warranty on all replacement devices whether or not the original warranty is still valid.

### **Our Service Line – Expert advice over the phone**

Solar power professionals can contact our SMA Service Line with any questions regarding installation and commissioning of the off-grid system. Our expert team for stand-alone grids provides our customers with advice and assistance at any time.

We also support you if an inverter happens to stop functioning as it should do. In this case, we first conduct initial analyses. This we do either via remote access, or directly, by means of data which our customers can provide via e-mail or using a memory card. After we do our research, we inform about the results at once.

### **SMA service on site – available worldwide**

You can rely on SMA. We currently have service technicians in 18 different countries and over 85 service locations around the world.

Should the analyses at the SMA Service Line determine that on-site servicing is required, our service technician will travel as quickly as possible to the plant. Once on site, the service technician will assess the problem in detail and will discuss with the installer what steps are to follow.

### **Commissioning assistanceFirst hand support**

Solar power professionals can also rely on our know-how for the installation and commissioning of off-grid systems. To ensure proper installation, we rely on the SMA commissioning report and the installation and user manual of the corresponding inverter. Among other things, we inspect the power cabling and take care of the configuration and parameter settings.

### **The SMA warranty concept – Flexibility. Guaranteed. Security. Guaranteed.**

SMA stands for high standards and excellent quality. Our inverters come with a five-year manufacturer's warranty.

We offer service custom-tailored to your needs with our SMA warranty concept. Our customers can flexibly choose between two different kinds of extended warranty, and can also decide whether the warranty should be extended for 10, 15, 20, or 25 years. Visit your local website for more information on the exact conditions available to you.

### **We are happy to assist you**

Do you have any questions or wishes, or do you need professional support? If so, you can contact our SMA Service Line at any time. The opening hours and telephone numbers of our expert teams are listed on our website at [www.sma.de/en/service](http://www.sma.de/en/service). The website provides information on our service, too.

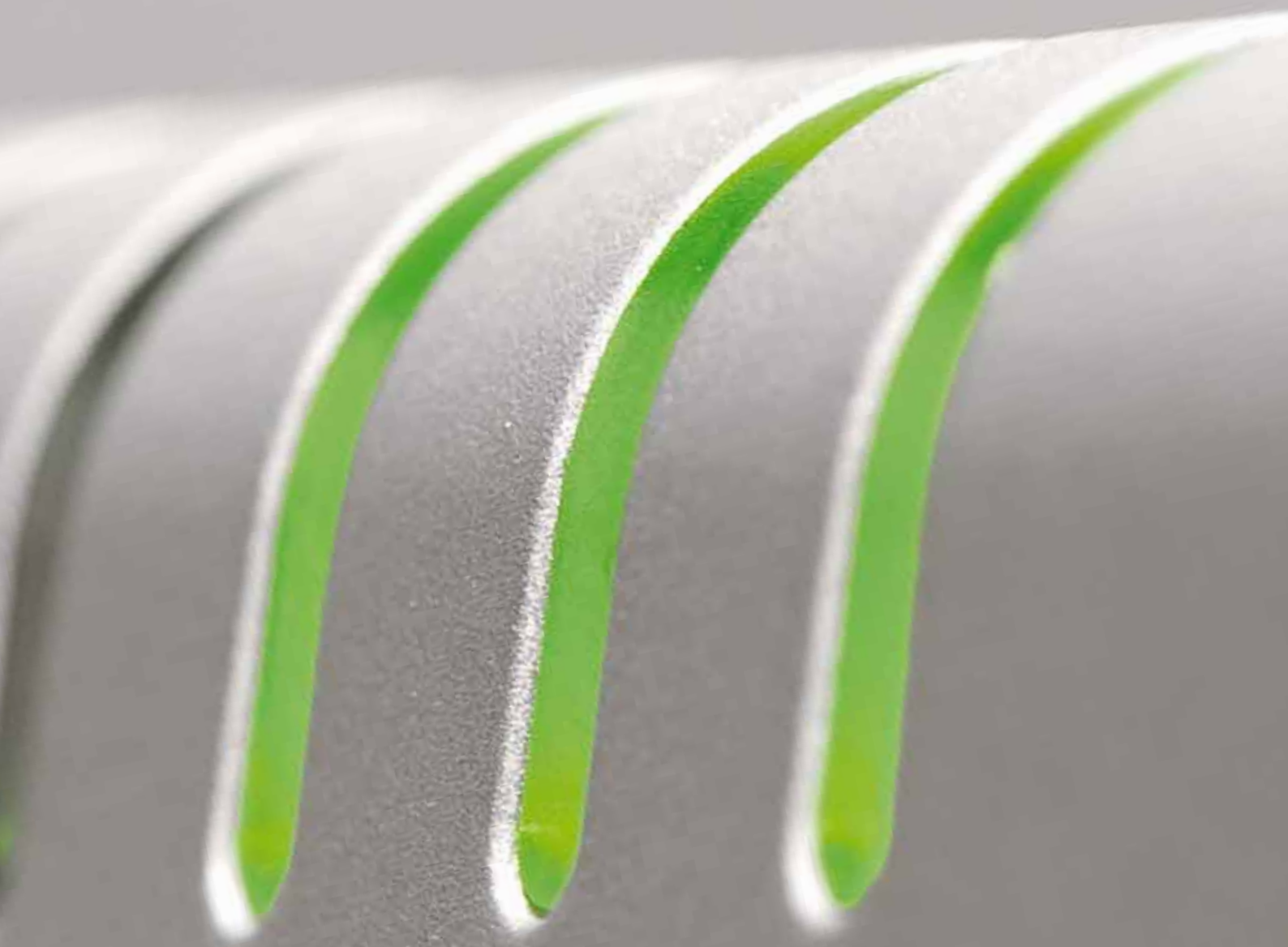

CARD  
SYSTEM  
POWER



# MONITORING SYSTEMS





# Monitoring, Informing, Presenting Yield Maintenance for PV Plants

Sunday afternoon at the garden fence. The sun is shining. Two neighbors are talking. One neighbor points to the PV plant on the other's roof. "So, how much is it generating right now?". The plant operator takes a quick look at the Sunny Beam. The neighbor is impressed with the answer. It's a good feeling: your PV plant is doing what it should – feeding solar power into the public grid and securing valuable yields. And best of all, the system (practically) takes care of itself. Thanks to the intelligent monitoring solutions from SMA.

## **Everything under control**

Comprehensive management is the key to profits for both small PV plants and large PV farms. By choosing a PV plant, operators are investing in an environmentally friendly technology as well as long-term profits. This means that the plant must run smoothly at all times. If reductions in output go unnoticed over longer periods, substantial loss of profits can occur. Continuous plant monitoring entails not only staying up-to-date on the amount of solar power being produced, but being able to react quickly to changes and problems.

## **Simple maintenance and configuration**

SMA plant monitoring also provides many benefits to solar power professionals. In the event of a problem, installers have quick access to all plant data. This information allows contractors to draw conclusions about a specific event and troubleshoot problems remotely. This can sometimes save on the need for long distance service visits. SMA products are also useful for plant maintenance and configuration. With Sunny Explorer, for example, you can access an inverter with a laptop equipped with a *Bluetooth* interface.

## **Simple and reliable – from any place in the world**

Modern PV plant monitoring is much more than just control. It provides information regarding plant operation in an easy-to-read manner and, thanks to the Internet and e-mail, is accessible from any location in the world. Plant performance data is presented continuously in a simple, clear and professional format. PV plant monitoring can also be used for display purposes, such as demonstrating a company's ecological commitment to the public.

PV plant monitoring can be accomplished in a number of ways and SMA offers a variety of options, including wireless or cabled connections, compact or complex, simple or extensive. Whether it is a residential system or a commercial system, monitoring is an essential component of any PV plant. And, to match the expected 20 year lifespan of SMA inverters, plant monitoring devices are also designed and manufactured using the highest quality standards.





RESIDENTIAL SYSTEM



COMMERCIAL SYSTEM



PV POWER STATION

# Threefold Simple and Reliable

## The Right Solution for Every PV Plant

The possible combinations for SMA monitoring are as different and multifaceted as PV plants themselves. To keep it simple for our customers, we have collected the monitoring solutions into three application scenarios.

### **Comfortable monitoring and control for residential systems**

For PV plants on single-family homes, for example, we recommend Sunny Beam or Sunny Explorer software. With our user-friendly and compact products, the operators can easily keep an eye on yields, around the clock.

### **Modular plant monitoring for commercial systems**

For larger PV plants, a variety of components can be assembled to create a customized monitoring solution. In combination with SMA PV inverters, operators and solar power professionals benefit from a perfectly-coordinated system. The product spectrum of plant monitoring products includes Sunny WebBox, Sunny Portal and Sunny WebBox with *Bluetooth*.

### **Reliable monitoring for PV power stations**

The larger the PV plant, the faster small reductions in power negatively affect yields – if they remain undiscovered. With our solutions designed especially for PV farms, even megawatt plants can be accurately and comprehensively monitored.



#### Easy to use

- Free PC software for monitoring the PV plant via *Bluetooth*
- Quick overview of yields and plant status

#### User-friendly

- Intuitive operation
- Graphic display of key PV plant data

#### Reliable

- Long-term archiving via data export in CSV format
- Rapid diagnosis via access to measured values and event memory



## SUNNY EXPLORER

The free PC software solution

Switch on your PC, activate *Bluetooth* and start Sunny Explorer. That's all that's needed to give operators and installers an overview of their PV plant. The free software is the optimum addition to inverters with *Bluetooth*. Key plant data can be visualized on a PC. Sunny Explorer also provides support during inverter parameterization. PV plant maintenance is convenient and fast thanks to quick access to measured values and the event memory.







#### User-friendly

- Wireless tabletop device with a large, easy-to-read display
- USB interface for data transmission to PC

#### Innovative

- Automatic monitoring of up to 12 inverters via *Bluetooth*
- Energy supply via integrated PV cell

#### Easy to use

- Intuitive operation via rotary switch
- Easy-to-understand display of all key plant data

#### Reliable

- Audio alarm in the event of faults
- Data archiving for at least 90 days in daily files and up to 12 monthly files in CSV format



## SUNNY BEAM with *Bluetooth*® Wireless Technology

The all-inclusive service package for the home

Informative, compact and easy to operate, the Sunny Beam with *Bluetooth* does not just look good; it's an innovative monitoring solution. Key data is visible on its large graphic display, including a daily profile, current output, as well as daily and total energy yield. The performance of up to 12 inverters, the monthly overview, the energy yield in euros, and the CO<sub>2</sub> values can be accessed very conveniently. And in the event of errors, the Sunny Beam can also be set up to emit an acoustic signal.

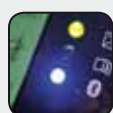

Wireless communication with inverters via *Bluetooth*

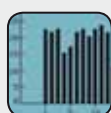

Large, easy-to-read LC display



Acoustic alarm system



USB interface for data transmission to PC and charging of the batteries



Simple and intuitive operation via the rotary switch

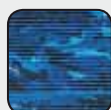

Energy supply via PV cell and battery



Compact and lightweight  
Dimensions:  
127 x 75 x 195 mm  
Weight: approx. 350 g

Technical data	Sunny Beam with <i>Bluetooth</i> <sup>®</sup>	
<b>Communication</b>		
Inverter communication	<i>Bluetooth</i>	
PC communication	USB 2.0	
<b>Max. communication range</b>		
<i>Bluetooth</i> in free-field conditions	Up to 100 m	
<b>Max. number of SMA devices</b>		
<i>Bluetooth</i>	Max. 12	
<b>Voltage supply</b>		
Voltage supply	Integrated solar cell, USB cable	
Number of batteries	2	
Type of battery	ENEKEEP (Mignon AA), NiMH (1.2 Vdc)	
<b>Environmental conditions in operation</b>		
Ambient temperature	0 °C ... 40 °C / 32 °F ... 104 °F	
Degree of protection (according to EN IEC 60529)	IP20	
<b>General data</b>		
Dimensions (W / H / D)	127 / 75 / 195 mm (5 / 3 / 7.7 inch)	
Weight	0.35 kg / 0.8 lb	
Mounting location	Indoors	
Mounting type	Benchtop	
Status display	LCD	
Software language	German, English, Italian, Spanish, French, Dutch, Portuguese, Greek, Czech	
Language of the manual	German, English, Italian, Spanish, French, Dutch, Portuguese, Greek, Czech	
<b>Features</b>		
Display	LCD	
Operation	Rotary switch	
Warranty	5 years	
Certificates and approvals	www.SMA-Solar.com	
<b>Information displayed</b>		
General information	Date / Time	
Plant data	Current output, daily yield, total yield, specific annual yield, CO <sub>2</sub> savings, earnings	
<b>Accessories</b>		
USB cable	●	
USB power supply unit	○	
Replacement batteries	○	
SMA <i>Bluetooth</i> Repeater	For extending the maximum <i>Bluetooth</i> communication range	
● Standard feature ○ Optional feature – Not available		
Type designation	Sunny Beam with <i>Bluetooth</i>	





#### Reliable

- Remote PV plant monitoring, diagnosis and configuration
- Data logger for all key plant data
- Rapid detection of operation failures

#### Easy to use

- Automatic monitoring of up to 50 inverters via *Bluetooth* or RS485
- Quick set-up thanks to the Sunny WebBox Assistant and quick reference guide

#### User-friendly

- Includes free standard access to Sunny Portal for the entire service life of the plant
- Flexible display, evaluation, yield and event reports via Sunny Portal



## SUNNY WEBBOX

### Remote monitoring and maintenance of medium-sized PV plants

The Sunny WebBox is the ideal monitoring solution for medium-sized PV plants. It receives and stores current measured values and transmits data via *Bluetooth* or RS485. This means you can stay updated on the status of your plant around the clock. In the event of a problem, you can react quickly and secure your yields. Parameters can be changed and a variety of measured values can be depicted, analyzed and downloaded via a web browser. All data from the connected devices is stored and automatically transmitted to Sunny Portal, if desired. The Sunny WebBox allows central access to your plant data on the Internet via Sunny Portal.



Communication with the inverters via RS485 or *Bluetooth*



Fast error detection thanks to optional sensors



Free, automatic visualization of the measured values in Sunny Portal



SD card slot for optional memory expansion and data transmission to a PC



Integrated web server enables online remote data access from any web-enabled PC in the world



Integrated FTP server for data transmission and storage on your PC



Quick set-up thanks to Sunny WebBox Assistant and the quick reference guide



Flexible data transmission to an arbitrary FTP server parallel to Sunny Portal possible

Technical data	Sunny WebBox	Sunny WebBox with <i>Bluetooth</i>
<b>Communication</b>		
Inverter communication	RS485, 10 / 100 Mbit Ethernet (only for Sunny Central)	<i>Bluetooth</i>
PC communication	10 / 100 Mbit Ethernet	10 / 100 Mbit Ethernet
Modem	Analog (optional), GSM (optional)	–
Data interface	Modbus TCP, RPC	RPC
<b>Connections</b>		
Ethernet	10 / 100 Mbit, RJ45	10 / 100 Mbit, RJ45
Inverters	1x SMACOM	–
<b>Max. number of SMA devices</b>		
RS485, Ethernet	50 / 50	– / –
<i>Bluetooth</i>	–	50
<b>Max. communication range</b>		
RS485	1200 m	–
Ethernet	100 m	–
<i>Bluetooth</i> in free-field conditions	–	Up to 100 m (can be extended with an SMA <i>Bluetooth</i> Repeater)
<b>Voltage supply</b>		
Voltage supply	External plug-in power supply	External plug-in power supply
Input voltage	100 V – 240 V AC, 50 / 60 Hz	100 V – 240 V AC, 50 / 60 Hz
Power consumption	Type 4 W / max. 12 W	Type 4 W / max. 12 W
<b>Environmental conditions in operation</b>		
Ambient temperature	-20 °C... +65 °C / -4 °F... +149 °F	-20 °C... +65 °C / -4 °F... +149 °F
Max. permissible value for relative humidity (non-condensing)	5 % ... 95 %	5 % ... 95 %
<b>Main memory</b>		
Internal	8 MB as ring buffer	12.5 MB as ring buffer
External	SD card 1 GB / 2 GB (optional)	SD card 1 GB / 2 GB (optional)
<b>General data</b>		
Dimensions (W / H / D)	255 / 130 / 57 mm (10 / 5.1 / 2.2 inch)	255 / 130 / 57 mm (10 / 5.1 / 2.2 inch)
Weight	0.75 kg / 1.7 lb	0.75 kg / 1.7 lb
Mounting location	Indoors	Indoors
Mounting type	Top-hat rail installation, wall mounting, tabletop device	
Status display	LEDs	
Software language, language of the manual	German, English, Italian, Spanish, French, Dutch, Portuguese, Greek, Korean, Czech	
<b>Features</b>		
Operation	Integrated web server (Internet browser)	
Warranty	5 years	
Certificates and approvals	www.SMA-Solar.com	
<b>Accessories</b>		
SMA <i>Bluetooth</i> Repeater to extend the max. radio range	–	○
Sunny SensorBox	○	○
SD card 1 GB / 2 GB (optional)	○	○
Outdoor GSM antenna / GSM card	○ / ○	– / –
RS485 communication cables	○	–
Plug-in power supply with adaptors	●	●
● Standard feature ○ Optional feature – Not available		
Type designation	Sunny WebBox	Sunny WebBox with <i>Bluetooth</i>



### User-friendly

- Central administration of all customer and plant data
- Easy-to-understand reporting
- World-wide access via the Internet – via PC or mobile phones

### Reliable

- Rapid diagnosis via access to measured values and event memory
- Key plant data archiving

### Informative

- Fully automatic yield comparison of devices in a plant
- Professional integration in personal website



## SUNNY PORTAL

Professional management, monitoring and presentation of PV plants

Whether for residential systems or commercial PV plants, centralized management and system monitoring saves time and money. Plant operators and installers have access to key data at any time. Specialized views take into account the requirements of different types of plants and target groups. The Sunny Portal features almost infinite options for analyzing data and visualizing yields, whether you need a data table or a diagram. The yields of all inverters in a plant are compared automatically, allowing for the detection of even the smallest deviations. The powerful reporting functions also provide regular updates via e-mail to help ensure yields.

Technical data	Sunny Portal
<b>Languages</b>	
Available languages	German, English, Italian, Spanish, French, Dutch, Portuguese, Greek, Korean, Czech, Chinese
<b>System requirements</b>	
Supported operating systems	All / optimized access for mobile devices
<b>Plant information</b>	
Plant description	Overview of the key properties of the PV plant
Annual comparison	Quick yield overview of the entire operating period
Energy balance page	Overview of grid feed-in, purchased electricity, and potentially self-consumption (electric meter connection via the Meter Connection Box is required)
Plant log book	Access to messages regarding plant events
Device overview	Properties and parameters of the devices in the PV plant
<b>Software</b>	
Recommended browsers	Internet Explorer as of version 8, Firefox as of version 5, Google Chrome as of version 14, Safari as of version 5, Opera as of version 11
Miscellaneous	JavaScript and cookies enabled
Supported data logger	Sunny WebBox, Power Reducer Box
<b>Access</b>	
Website	www.sunnyportal.com
Smartphone	www.sunnyportal.mobi, Sunny Portal App for iPhone and Android
<b>Plant management</b>	
Sunny Portal Account	One password for all your plants in Sunny Portal
<b>Monitoring</b>	
Inverter comparison	Fully automatic and ongoing inverter yield comparison and e-mail alarms
Communication monitoring	Ongoing monitoring of the connection between Sunny Portal and the PV plant
<b>Status reports</b>	
Information reports	E-mail reports provide regular information on plant yields
Event reports	E-mail reports on plant status information, warnings, faults and errors if an event occurs.
<b>Individual access</b>	
Publication of specific pages	Access via the public area on Sunny Portal by all Internet users, ideal for personalized presentations on personal websites
User roles	By assigning the roles of "guest", "standard user", "installer" and "plant administrator", you can easily determine who has which viewing and configuration rights.
<b>Page design<sup>1</sup></b>	
Standard pages	Automatic standard pages for the most common plant monitoring and presentation needs
Personalized pages	A variety of templates for page design
Page modules	Tables, diagrams, own images, free text, plant overview (CO <sub>2</sub> earnings, energy)
<b>Visualization of yield and measured values<sup>1</sup></b>	
Diagram types	Selection of six diagram types for optimal presentation of yield and measurement values, bar graphs, area charts, and line charts (with, without, or only tags), as well as XY diagrams
Tables	Individual configuration of charts for all yield and measured values
Time periods	From 5 minutes to 1 year, various time intervals selectable (depending on provided data)
<sup>1</sup> Advanced display option for the Sunny WebBox	
Type designation	Sunny Portal



#### Reliable

- Rapid error detection via continuous target-actual comparison of plant performance

#### Informative

- Precise measurement of irradiation intensity, module temperature, ambient temperature and wind speed

#### Easy to use

- Easy integration in existing PV plants per RS485 or *Bluetooth* (via SMA Power Injector with *Bluetooth*)
- Data analysis via Sunny WebBox or Sunny Portal



## SUNNY SENSORBOX

The weather station for PV plants

The Sunny SensorBox is installed directly onto the modules and measures solar irradiation and module temperature, optionally, wind speed and ambient temperatures. In combination with Sunny WebBox and Sunny Portal, it enables a continuous target/current comparison of the plant power. This makes it possible to detect shading, dirt, and a gradually declining array performance, thus maximizing yield security.







#### User-friendly

- Logging the electricity purchased from the grid, feed-in and self-consumption
- Clear display of data for analysis in Sunny Portal

#### Easy to use

- Convenient installation with SMA communication products
- Easy integration into existing PV plant monitoring via RS485

#### Flexible

- Compatible with standard energy meters with an SO impulse output



## METER CONNECTION BOX

Analysis of energy consumption made easy

The ideal tool for optimizing energy consumption: The Meter Connection Box makes it easy to integrate energy meters into your plant monitoring system. It is connected directly to the SO output of an energy meter, where it reads the meter changes. In combination with the Sunny WebBox and Sunny Portal, this allows you to conveniently and transparently view and analyze your personal energy balance. Depending on the constellation of connected energy meters, the device allows you to visually compare your purchased and generated energy as well as your PV self-consumption.





### Reliable

- Complies with the requirements for Germany's Renewable Energy Sources Act (EEG) on feed-in management
- Logging of all events and change of status
- Meets the requirements of the German Medium-Voltage Directive (BDEW) for grid safety management

### Flexible

- Active power limitation and reactive power setpoint
- Reliably controls up to 2 500 SMA inverters

### Easy to use

- Straightforward integration into existing systems
- Easy installation
- Free support from the SMA Service Line
- Integrated web server



## POWER REDUCER BOX

### Feed-in management for PV plants

With the Power Reducer Box, SMA delivers a solution for PV plants that take part in feed-in management. It allows the grid operator to remotely control the plant performance in cases when the grid is overloaded. It achieves this by translating the transmitted setpoint values into control commands for the Sunny WebBox, which forwards them to the inverters. During this process, each change of status is logged several times, once in the Power Reducer Box and once in the Sunny WebBox. In addition, the grid operator's requirements are visualized in Sunny Portal. Sunny Portal immediately informs the plant operator via e-mail about power limitations that have been undertaken.





#### Professional

- Control and monitoring of PV plants
- Simple integration into professional control room technology such as HMI, SCADA or BM systems

#### Innovative

- One data interface for up to 2 500 SMA devices
- Data interface in accordance with the communication standard OPC-DA/OPC-XML-DA

#### Easy to use

- One data interface for 50 Sunny WebBox devices, even at different locations
- Easy installation and intuitive configuration

#### Flexible

- Compatible with WinCC, InTouch, WEBfactory, etc.
- Quick and simple integration into existing control systems, e.g., for wind turbine systems or biogas plants



## SMA OPC SERVER

The standardized data interface for large-scale PV plants

Large-scale PV plants require customized monitoring solutions and need to link systems and components supplied by different manufacturers into one joint control system. OPC, the international communication standard in the field of automation technology, enables simple and reliable data exchange between products and applications supplied by different vendors.





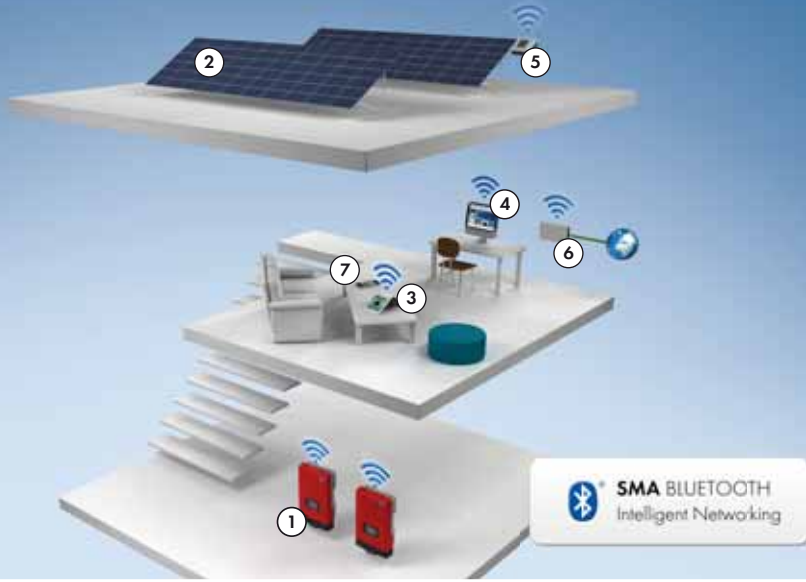

### Typical plant design – wireless transmission

#### Electricity generation

- ① Sunny Boy
- ② PV array

#### Plant monitoring

- ③ Sunny Beam with BT
- ④ Sunny Explorer  
Sunny Portal
- ⑤ Sunny SensorBox with BT\*
- ⑥ Sunny WebBox with BT
- ⑦ Mobile access

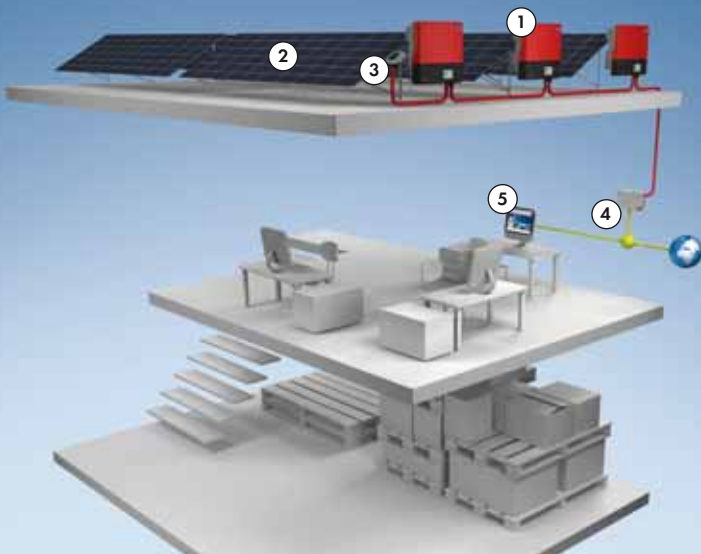

### Typical plant design – cable transmission

#### Electricity generation

- ① Sunny Boy
- ② PV array

#### Plant monitoring

- ③ Sunny SensorBox
- ④ Sunny WebBox
- ⑤ Sunny Portal

- RS485
- Local network / Internet

#### Bluetooth

- Automatic networking of up to 50 devices
- Range of up to 100 m in free-field conditions

#### RS485

- Reliable data transmission, even in interference-prone areas
- Various accessories available (radio links, fiber optic converters)

## Wireless or cable

Secure connection with and without cable

To monitor PV plants, data has to be transmitted. For the communication between the PV inverter and monitoring devices, SMA provides two basic choices: wireless and wired variants. Both have advantages and are used with differently sized plants. Let SMA help you decide which method of communication best suits your PV plant.

\*In connection with SMA Power Injector with Bluetooth

	<b>Bluetooth (radio connection)</b>	<b>RS485 wiring</b>
<b>Typical application</b>	Especially for small and medium-sized PV plants	For medium-sized and large PV plants
<b>Benefits</b>	Reduced costs and effort	High speed and reliability
<b>Number of nodes</b> <small>(PV plant monitoring and inverters)</small>	Up to 50 per <i>Bluetooth</i> network	Up to 50 per RS485 bus
<b>Range</b>	Up to 100 m in free-field conditions between individual devices	1 200 m per RS485 bus
<b>Number of data retrieval devices</b> <small>(for example, Sunny Beam or Sunny WebBox)</small>	Up to four per network (depending on number of nodes)	1 per RS485 bus
<b>Feed-in and grid management option</b>	None	SMA Power Reducer Box*

### Wireless success – intelligently networked with SMA WebBox with *Bluetooth*

With SMA *Bluetooth* wireless networks can be created simply and quickly – without the additional effort of having to lay cables in walls, re-plaster or paint. It's perfectly suited to your private residential system.

*Bluetooth* the international wireless standard makes monitoring flexible and extendable. Solar power professionals and plant operators save time and installation costs. Thanks to *Bluetooth* all new inverters are recognized quickly and automatically integrated into the plant. With the SMA intelligent networking concept, up to 50 devices can be integrated in a network. *Bluetooth* Class 1 is the used standard, which enables communication over longer distances. If that's not enough because walls or ceilings are in the way, you can also use the SMA *Bluetooth* Repeater. *Bluetooth* also stands up in terms of reliability. Thanks to constant frequency changes and the transmission of data packages in small units, the radio connection is extremely stable. By the way: the password protection built in to all devices secures your data against unauthorized access.

### Robust and secure – powerful across long distances with proven RS485 wiring

The RS485 fieldbus is a veteran in the area of cable-connected communication technology. It has been used by SMA for many years and has proven itself in a nearly endless number of plants. All devices are connected to each other in a chain (a so-called data bus). At the end of this chain, the Sunny WebBox collects all the data and reliably informs you of the status of the PV plant. The advantage of RS485 wiring is that functional lengths of up to 1 200 m and reliable data transmission can be achieved even in interference-prone areas. It is also appropriate for larger PV plants, where operators require maximum security and reliability.

\* Information on regulations for feed-in and grid management in your country can be obtained from your grid operator.

# SMA SOLAR | ACADEMY

Be a solar expert







**SMA SOLAR | ACADEMY**



#### **Comprehensive**

- Expertise on SMA inverter technology and photovoltaics
- Several hundred seminars annually worldwide for newcomers and experienced users

#### **Targeted**

- Training courses tailored specifically for installers, sales staff, plant planners and solar power professionals
- Seminars on products or specific subject areas

#### **Hands-on**

- Specially trained instruction team
- Exchange with SMA developers and seminar participants
- Opportunity to practice with products

#### **Cooperative**

- Comprehensive seminar documentation
- Sharing experiences over lunch

## **SMA SOLAR ACADEMY**

Sharing knowledge. Giving you the competitive edge.

Greater success through added know-how: SMA Solar Academy provides expertise and targeted training in the area of photovoltaics. The various seminars and trainings help you keep on top of the latest trends, new developments and topics in the PV industry, adding competence with a hands-on approach.

### Information for an overview - but with depth

Solar power professionals receive the information and consulting they need to tackle their projects on a daily basis through our seminars and training programs. The curriculum is not limited to general knowledge of photovoltaics including planning, designing, selection of inverters, and plant communication and monitoring. The courses also convey facts and figures on useful topics such as storage, legal directives, service, self-consumption, and energy management.

### Always up-to-date and future-oriented

The instructors at the SMA Solar Academy are always on top of the latest developments: each seminar contains the latest known conditions, as well as any potential updates or

status changes. Participants can rest assured that the knowledge they gain in the seminars and courses will still be relevant in the near future.

### Regional and international training programs

We are the world's leading manufacturer in 19 countries: SMA Solar Academy offers training programs to solar power professionals and system integrators at all SMA subsidiaries to ensure a common standard around the world. There are seminars available for solar power professionals at our headquarters in Niestetal (near Kassel), in Heilbronn, and in Landshut, Germany. In addition, we have SMA Solar Academy experts in a number of cities operating through regional forums to instruct and inform solar power professionals. Relevant, valuable, and easy to understand.

### » Interested in the range of seminars offered by SMA Solar Academy?

Simply choose your desired seminar at [www.SMA.de/solaracademy](http://www.SMA.de/solaracademy) and register online. We look forward to your participation!

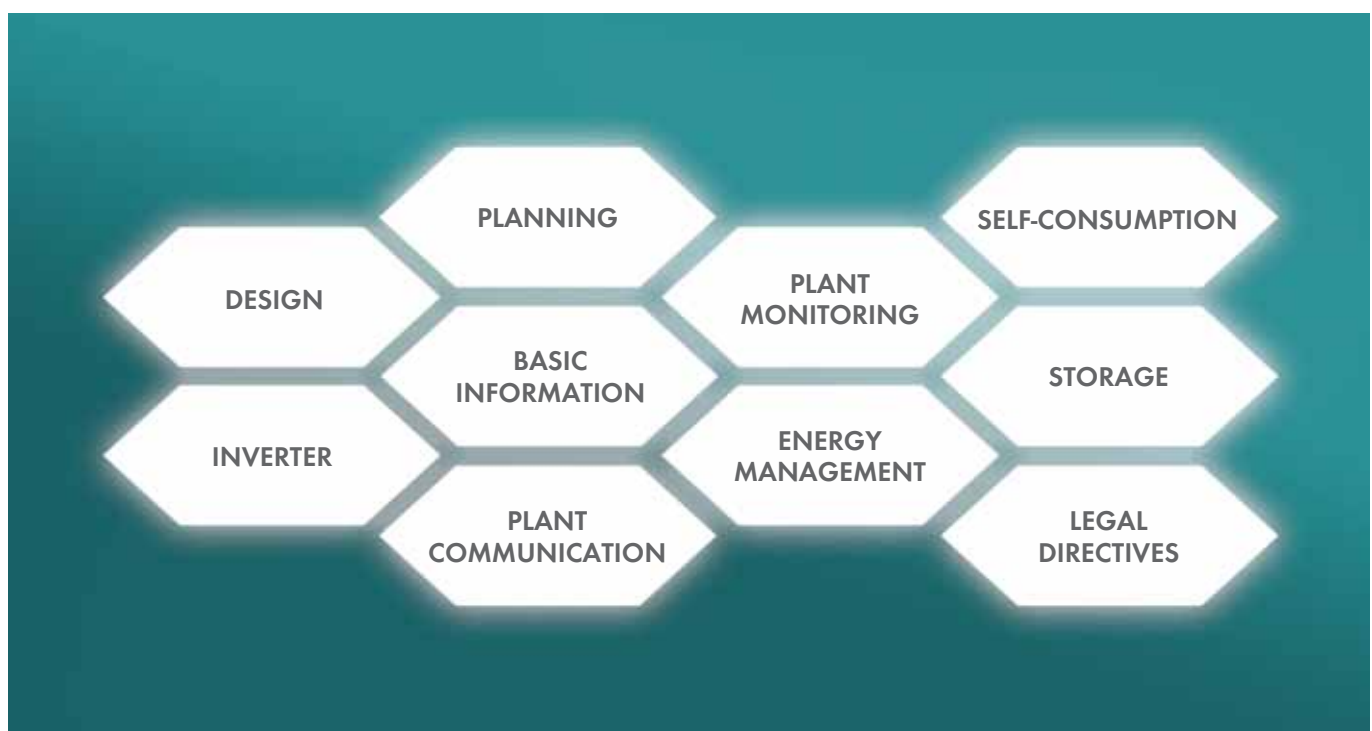







# KNOW-HOW





# Design of PV plants

## Three steps to success

The possibilities for plant design are vast. There are many different module types, various inverters, roof pitches, locations and many more. The right design of a PV plant is crucial for the anticipated yield. The most important design decisions can be summarized in the following three steps. Take into

account the fundamental technical context as well as guidelines and rules of thumb for the design of a standard PV plant in parallel grid operation. If deviations from the required standard conditions occur, the specified guidelines must be modified accordingly.

## 1. Incorporate the inverter's electrical limiting values

First of all, the voltage of the array must match the inverter. The limits are defined by the MPP voltage at the highest cell temperature (standard: 70 °C) and the open-circuit voltage at the lowest cell temperature (standard: -10 °C). The maximum plant voltage of the PV modules can also limit the open-circuit voltage of the array.

## 2. Determining the optimum nominal power ratio

The basis for sizing the inverters is the nominal power ratio, i.e., the relationship between the inverter's maximum DC power and the peak power of the connected PV array. The most efficient orientation in Germany for a typical power plant with a slightly smaller sized inverter is facing the south, which corresponds to approximately 90 percent. The reason for it is that the inverter's maximum power is only needed at certain times of the

day if the irradiation conditions are also ideal. By limiting the inverter's power (the last ten percent) only reduces the PV plant's energy yield by 0.2 percent, which means the savings in investment costs supercedes the reduced inverter power.

The optimum nominal power ratio can be substantially less for a PV array facing in a different direction. For example, east/west PV arrays that are run on an inverter only need to have approximately 60 percent of the overall array power in certain cases.

## 3. Use the maximum efficiency of the inverter

Every inverter has an input voltage at which its conversion efficiency is maximized. Whether this voltage lies in the upper or lower area of the operational range depends on the internal design and is listed in the respective datasheet. If possible, the MPP voltage of the PV modules at NOCT (Normal Operation Cell Temperature) should be close to this voltage.

Though professional design of a PV plant includes many more steps, the three basic decision steps above largely determine the future yield. SMA offers the free software Sunny Design, which incorporates all the aspects of plant planning and is the only planning tool available on the market capable of determining the optimum nominal power ratio.

### Information

For more background information on calculating the optimum dimensioning for inverters using Sunny Design, see the spread on the following pages.





# Plant design 2.0

New methods of optimum dimensioning for inverters

Sunny Design, the newest version of SMA's planning software, now enables you to precisely set the rated power ratio of the PV plant for the efficiency. It becomes an advantage in particular when the PV array is not oriented to the south, as it typically would be.

## **Standard case: south-facing roof**

The basis for sizing the inverters is the nominal power ratio, i.e., the relationship between the inverter's maximum DC power and the peak power of the connected PV array. Typically, a PV plant facing to the south is the most efficient choice when the inverter is slightly smaller (for example, at 90 percent in Germany). The reason for it is that the inverter's maximum power is only required at certain times of the day and only if the irradiation conditions at the same time are ideal. By limiting the inverter's power (the last ten percent) only reduces the PV plant's energy yield by 0.2 percent, which means the savings in investment costs supercedes the reduced inverter power.



### Extreme case: east/west-facing plant

Once the PV array deviates greatly from the optimum orientation, this “rule of thumb” of 90 percent is no longer valid for the nominal power ratio. Instead, a much smaller inverter size could make more sense if you plan to attain the optimum energy efficiency of 99.8 percent.

For example, the optimum nominal power ratio in Germany is approximately 80 percent for an east-facing PV array; however, this value varies depending on the roof pitch. Another serious advantage in sizing occurs with two substrings facing east and west and run on a multistring inverter. If both substrings achieve the same peak power, only 60 percent of the total peak power is required as DC inverter power in certain cases. The reason for it is the distribution of the array power based on time of day: east- and west-facing arrays attain their maximum power at different times of the day, meaning the inverter’s maximum power is only slightly higher than the maximum power of the individual substrings. If their peak power is approximately the same, the total available energy remains around the same over the course of the day. For this reason, substantially less DC power is required from the inverter to achieve 99.8 percent of the available PV power.

The inverter would never attain the power ratio of 90 percent for nominal power in a “standard” design, which is an unfavorable solution for two reasons. For one, the extra inverter power increases the investment costs of the plant. And for another, even worse yet is the running loss in yield caused by the general shifting of the operating points into the less efficient partial load range of the inverter. The wrong sizing can then noticeably worsen the device’s average efficiency.

### The path to an optimum design

The example with the east-/west-facing plant shows how important it is to take the orientation, pitch, and peak power of each substring into consideration when determining the most efficient nominal power ratio, in addition to the plant location. The planner then receives a DC inverter power that allows usage of 99.8 percent of available solar energy. Calculating this value is anything but trivial. It needs to be based on a simulation in which all listed parameters including the climatic conditions on-site are taken into account. The latest version of Sunny Design, the free SMA design program, is capable of running this simulation. Furthermore, it is designed to be the initial planning tool when determining the required DC inverter power based on a predefined and most efficient energy usage factor. The algorithm also includes provisioning of any reactive power that may be required since it may also affect the sizing of the inverter.

### In summary

Plant design using Sunny Design enables you to determine the optimum nominal power ratio and avoid having unnecessary inverter power. At the same time, it allows you to maximize operational efficiency of the inverter you choose. In this regard, the SMA planning tool is also making a major contribution to reducing the cost of solar power.

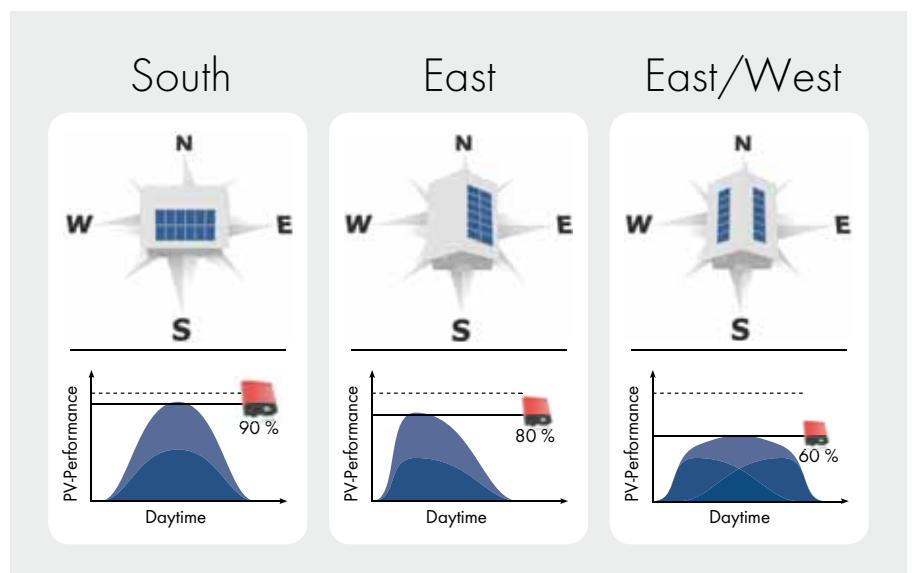

The ideal nominal power ratio depends greatly on the direction that the PV array faces





# Which inverter is the right one?

The optimized solution for every type of module technology

Specialist retailers already offer thousands of module types today, adding new ones every year. Various new models are also released every year, especially in the business area of thin-film technology, but there is also an enormous range of inverters. Problems can also arise when modules based on different technologies are used if an incompatible inverter is chosen. However, there is good news on the horizon: SMA offers the right inverter for every module technology.

## **The most important module technologies**

PV modules with cells made of mono- and polycrystalline silicon (c-Si) dominate the market today with a share of more than 80 percent. They consist of approx. 0.2 mm thick silicon wafers that are either laminated between two panes of glass or between a film layer and a pane of glass.

Much less semiconductor material is required for thin-film PV cells. Here, a layer with a thickness of only a few micrometers is deposited and divided into individual cells that are connected accordingly. In addition to amorphous silicon (a-Si), cadmium telluride (CdTe) and copper indium gallium selenide (CIGS) are used as active material. On the front side, electric contact between the cells is established through a transparent conductive oxide (TCO) layer.

As an alternative, thin-film PV cells can also be deposited on a film, which can be used to produce flexible, very lightweight PV modules. These cells are attached to the surface of a curved or other structures with low loading capacities, such as greenhouses or airplane wings.

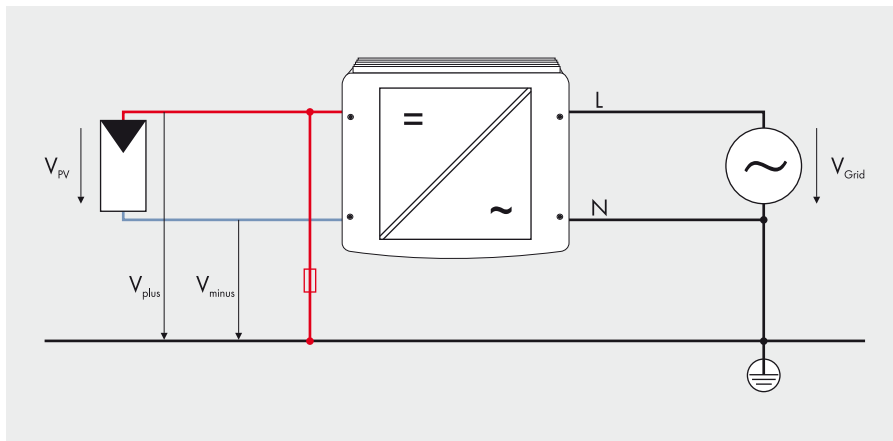

Block circuit diagram: PV plant with positive array grounding

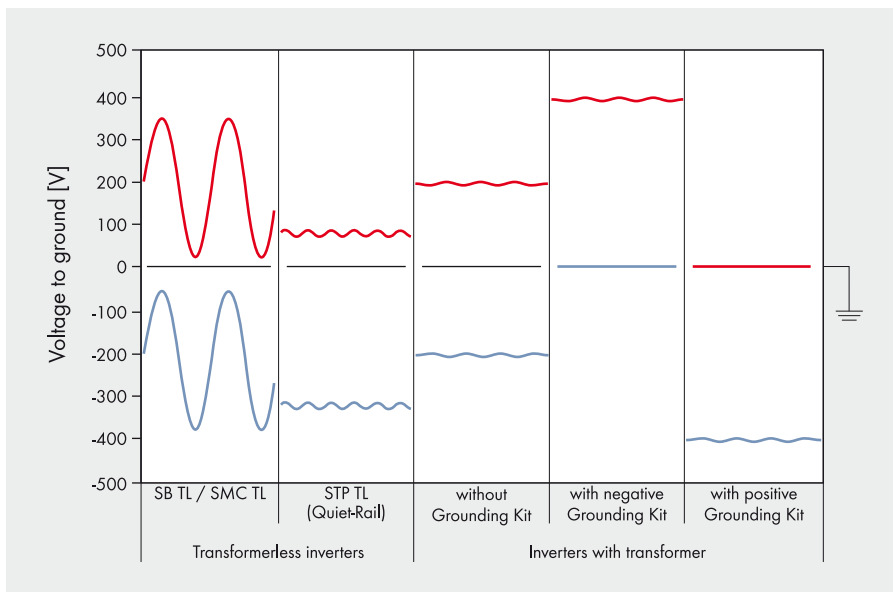

Generator potential in different inverter topologies and grounding variations

## Challenges in the area of modules

The following section will explain the four most common complications occurring when using modules based on different technologies. Table 1 on the following spread provides another overview of this and offers a rough estimate of the corresponding probability of occurrence.

### 1. TCO corrosion

Sodium ions from the glass cover can penetrate the interior of the PV module as a result of the negative potential. If the glass comes into direct contact with the TCO layer (usually in  $\alpha$ -Si and CdTe modules), the sodium ions together with the moisture can attack the TCO: The edge of the module turns milky white and loses its conductivity. The performance of the module is irreversibly affected; at first, only a little at a certain degree of damage, afterwards almost entirely.

### 2. Polarization

The migration of sodium ions as it occurs in TCO corrosion also affects some crystalline modules. However, in this case, the ions remain stuck in the laminated film and are not able to adversely affect the performance curve of the PV module. The performance loss is generally reversible, meaning the damage to the modules is not permanent if the appropriate measures are taken. A mix of polarization and TCO corrosion can also occur in thin-film technologies where the TCO from the glass cover is separated by a film (in CIGS generally). The sodium ions can also remain stuck in the film, and change the curve of the PV module. Currently, there is little known about the extent of the performance loss and the issue of reversibility.

### 3. Leading leakage current

In essence, a PV module is an electrically conductive surface connected to a grounded frame; it behaves similarly to a plate-type capacitor. For this reason, the entire PV cell is alternatively charged and discharged in inverters with periodically changing voltage to the ground; this results in measurable current flows. The amount of these leading leakage currents depends not only on the inverter's DC-side potential curve, it also depends on the weather and how the modules are attached. In the worst-case scenario, they attain the maximum permitted residual current, meaning the inverter needs to be disconnected from the power distribution grid.



#### 4. Leakage currents

Every PV plant should be insulated as well as possible in order to avoid leakage currents and any potential damage to people or property. All PV modules and corresponding cable and plug connectors available today are protection class II and feature double or reinforced insulation. Furthermore, modern inverters check the insulation resistance of the PV array every time prior to connecting.

Monitoring of the insulation resistance ( $R_{iso}$ ) is not mandated by law for inverters with galvanic isolation, because a minimum of two insulation errors need to occur before leakage current arises. Nevertheless, SMA safety policy states that SMA inverters need to feature an insulation monitoring system because the insulation resistance is a good indicator of the PV array's condition. However they only show a warning signal when the insulation resistance is lower.

Transformerless inverters are not permitted to feed into the power distribution grid with a leakage current exceeding 5 mA (corresponds to 200 k $\Omega$  at a voltage of 1,000 V), a value that can be attained under wet conditions even with a completely intact PV array with peak power of 10 to 20 kW. It happens even more easily the bigger the overall surface area of the PV array on which an inverter operates. However, damaged plugs could also be the culprit.

## Selecting the appropriate inverters

The versatile range of different topologies allows a flexible application of SMA inverters – combined with the suitable grounding set – providing the ideal device for any module technology. The temporal characteristics of the array connectors play a key role when selecting the right inverter topology and grounding version (see figure on the previous pages).

Table 2 shows valuable combinations of module technology and SMA inverters with which the four challenges listed above can generally be overcome without any problems. You must follow the module manufacturer's recommendations on grounding the PV array or on the topology of the relevant inverter. In specific cases, the manufacturer may recommend using constellations that are listed in table 2 as not possible or deviating instructions such as using a positive PV array grounding. SMA is in close contact with the module manufacturers, which means that current installation recommendations can be observed in any case.

## Example A

A manufacturer recommends grounding the positive generator connection for a specific module type. The right choice: A Sunny Boy with transformer and a positive grounding set.

## Example B

Thin-film PV modules with CdTe or amorphous silicon cells. These modules often use a TCO-coated pane of glass as a substrate. The right choice: A Sunny Boy with transformer and a negative grounding set.

## Example C

In case of flexible thin-film PV cells, a stainless steel foil is often used as substrate. Use an inverter topology in which the PV array only features a small amount of AC voltage to the ground. The right choice: A Sunny Boy with a transformer or a transformerless device with Quiet Rail Technology (e.g. Sunny Tripower). It prevents reverse effects of the line voltage on the generator potential via special wiring.

## Information

You can download more technical information on module technology from the SMA website free of charge.

Module technologies	Possible complications			
	TCO Corrosion	Polarization	Leading leakage currents	Leakage currents
c-Si	○	●	○	○
α-Si	●	○	○	○
CdTe	●	○	○	○
CIS/CIGS	○	●	○	○
Flexible thin-film PV modules	○	○	●	○

Legend: ○ Not observed, ○ Low probability, ● Medium probability, ● High probability, ● Very high probability

Table 1: Possible complications when using modules based on different technologies

Module technologies	Suitable inverters			
	without transformer		with transformer	
	SB xxxxTL SMC xxxxxxTL	STP xxxxxxTL / TLHE (Quiet-Rail)	SB xxxx, SMC xxxxxx (Series device)	with negative grounding set
c-Si	●	●	○	○
α-Si	–	–	–	●
CdTe	–	–	–	●
CIS/CIGS	–	–	–	●
Flexible thin-film PV modules	–	●	○	○

Legend: ● Recommended, ○ Not necessary, – Not recommended

Table 2: Recommended combinations of inverters and module technologies



# Key topic of the future: PV grid integration

## PV inverters as grid managers

The subject of grid integration coupled with renewable power generation is playing an increasingly important role. The powerful growth in total power for Germany's PV plants is attracting considerable attention, and rightfully so: according to data by the Federal Network Agency, a total of more than 25 gigawatts of PV power has already been installed in the grid since the end of 2011. Under ideal irradiation conditions in Germany, the PV plants generate more power than 16 large-scale nuclear power plants. Which is why it is still extremely important that we establish the ideal method for integrating this decentralized and fluctuating power generation capacity into the existing distribution grid with a unidirectional energy flow.

### Guidelines, rules and laws

For a long time, PV plants were only considered "negative consumers" with a pure active power supply. However, photovoltaics have increasingly been integrated into the grid regulations since 2009. For example, various system requirements for larger plants<sup>1</sup> that are ultimately targeted at improving the way decentralized power generation plants are integrated into the grids exist with Art. 6 of the Renewable Energy Sources Act (EEG)<sup>2</sup> and the medium voltage directive of the German Association of Energy and Water Industries (BDEW). On August 1, 2011, fundamental new connection regulations according to which small and medium-sized PV plants are also required to provide system services now came into effect for the low-voltage grid that, after all, absorbs around 85 percent of the PV power available in Germany. Being the market and technology leader in the field of PV system technology, SMA has been very committed to the subject of grid integration from the very beginning by participating in the relevant committees

<sup>1</sup> Renewable Energy Sources Act (EEG)

<sup>2</sup> Medium-voltage directive issued by the German Association of Energy and Water Industries (BDEW)

<sup>3</sup> VDE-AR-N 4105: Power generation plants connected to the low-voltage grid - Minimum technical requirements for the connection to and parallel operation of power generation plants on the low-voltage grid



and working groups, on the one hand, and by undertaking massive development efforts, on the other hand. And this commitment has been crowned with success: SMA inverters were among the first to achieve full compliance with the requirements of Art. 6 of the Renewable Energy Sources Act (EEG) and the progressively adopted medium-voltage directive. SMA offers a wide range of corresponding product solutions<sup>3</sup> for the VDE application guide 4105, which has been in effect since January 1, 2012.

### Inverters as grid managers

The regulations that govern the different grid levels are both complex and comprehensive. They include the planning rules for PV plants and specific functional requirements for the inverters used; however, the latter contains little distinction between low-voltage and medium-voltage levels. The following section provides an introduction and brief explanation of the functional requirements required by law.

## 1. Feed-in management

60 seconds: Inverters in Germany have just one minute to implement possible specifications of the grid operator on feed-in management. If a section of the distribution grid is temporarily overloaded, the distribution grid operator can and must limit the power in PV plants remotely.

The product solution for large-scale PV plants is the Power Reducer Box. The SMA Power Reducer Box converts the incoming setpoint specifications into control commands for the Sunny WebBox. This in turn forwards the commands to the connected inverters via fieldbus, and logs the external setpoint specification. In Germany, installation of an upstream power relay with remote control for grid disconnection is sufficient for PV plants with peak power less than 100 kW.

## 2. Active power limitation in case of overfrequency

The frequency in alternating current grids is kept constant within strict limits, typically at exactly 50 Hz or 60 Hz. The frequency increases if less energy is consumed than the arrays feed-in. A small increase in the frequency used to cause all PV inverters to immediately disconnect from the grid based on the previous connection rules, even if the limiting value was only exceeded for a brief moment. This would endanger the stability of the European power distribution grid in view of the more than 25 gigawatts of installed PV power in Germany alone. For this reason, the medium-voltage rule and the VDE application guide for the low-voltage grid lay out a different approach for inverters: the systems need to gradually reduce their active power output and only disconnect from the grid when the frequency greatly increases.

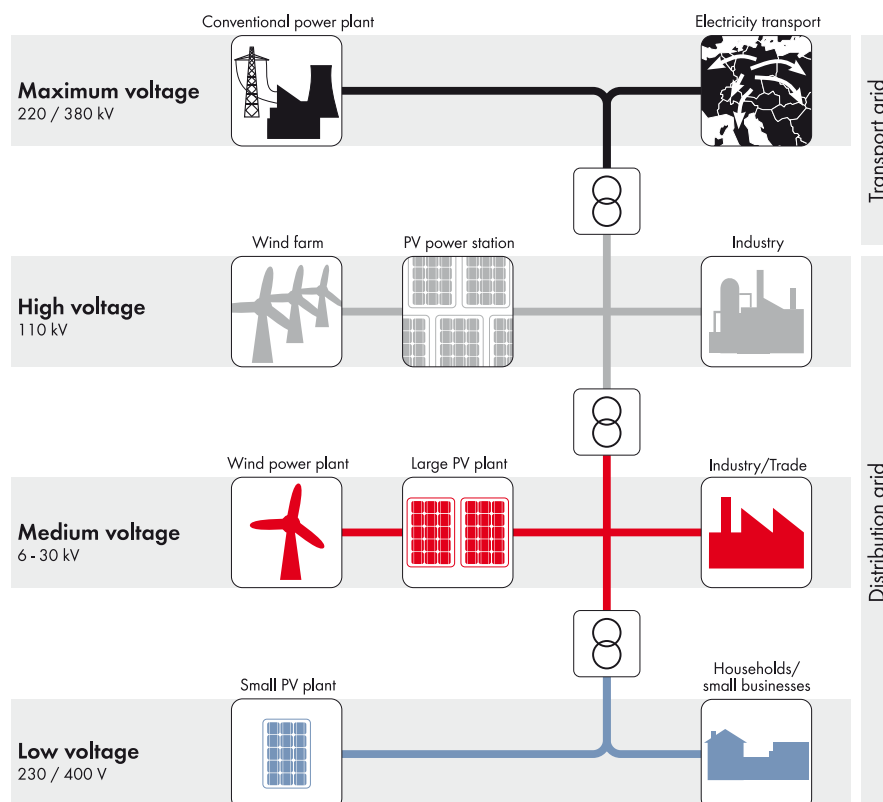

A schematic of the grid levels in the German AC power distribution grid



### 3. Static voltage-stability based on reactive power

Similar to the frequency, the line voltage must also be kept within defined limits, especially on the low-voltage level, i.e., the distribution grid. With their ability to provide reactive power in a controlled manner, PV inverters can help guarantee the voltage quality required by EN 50160 at the respective grid connection point.

Specifically: By using reactive power, the devices can reduce undesirable voltage increases significantly. Inverters capable of utilizing reactive power can also be used to compensate for unwanted reactive power present in the grid, which is caused, for example, by transformers, large motors or long cable sections.

This method can be used to largely avoid traditional grid expansion measures. A study conducted by Roland Berger on behalf of the German Solar Industry Association (BSW) This method can be used to largely avoid traditional grid expansion measures. A study conducted by Roland Berger on behalf of the German Solar Industry Association (BSW) found that the provision of reactive power has the greatest potential for integrating decentralized power generation systems into the grid: the capacity of the existing distribution grids could be virtually doubled. There are several options for adjusting the percentage of reactive power:

Plant operators can use target values specified by utility operator. Alternatively, various reactive power values can be set via an agreed schedule or remotely programmed via the SMA Power Reducer Box.

The third option is regulation of the percentage of reactive power via a characteristic curve depending on the line voltage measured at the connection point or the active power output of the inverter. The latter calls for all inverters with more than 3.68 kVA apparent power to adhere to VDE application guide 4105 since the beginning of 2012.

### 4. Dynamic grid support

Until now, PV plants had to disconnect from the grid immediately, even during temporary drops in line voltage, which is problematic given the increasing amount of PV power on the grid: Even temporary system incidents that are generally easy to control can cause the sudden shutdown of large power generating capacities, thus unbalancing the grid. The medium-voltage directive therefore requires that PV inverters support the grid when a fault occurs: They should be able to remain connected to the grid during voltage dips that last up to 1.5 seconds and then immediately resume normal feed-in operation. The inverters must also be able to supply reactive power to the grid during voltage dips so that they can help trip the grid protection devices.

The Sunny Central CP and Sunny Tripower series of SMA inverters were designed from the very beginning to have this functionality, which makes SMA the first manufacturer who can show the necessary unit certificates for the relevant inverter models starting in April 2011.

## Equipped for the future with SMA know-how

Providers of decentralized grid services and an intelligent interface to the power distribution grid: that describes the PV inverter of the future.

The grid operators have also recognized that inverters are particularly predestined for the pending grid management responsibilities – and demand these system services to an ever greater extent. The system technology of SMA is making an important contribution in this matter.

## Information

For details and current information, please visit [www.SMA.de/netzintegration](http://www.SMA.de/netzintegration).

### SMA inverter grid management functions<sup>1</sup>

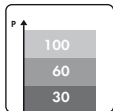

#### Remote-controlled active power limitation (feed-in management)

In order to avoid short-term grid overload, the grid operator presets a nominal active power value which the inverter will match within 60 seconds. The target value is transmitted to the inverters via a ripple control receiver in combination with the SMA Power Reducer Box. Typical limiting values are 100, 60, 30 or 0 per cent of the nominal power.

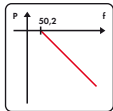

#### Active power limitation in case of overfrequency

As a power frequency of 50.2 Hz, the inverter automatically reduces the active power output according to a definable characteristic curve, contributing to stabilize the power frequency.

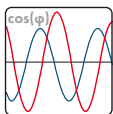

#### Static voltage-stability based on reactive power

SMA inverters provide leading or lagging reactive power in order to stabilize the grid voltage. Three different modes are available:

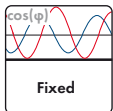

##### a) Fixed specification of the reactive power by the grid operator

The grid operator defines a fixed reactive power value or a fixed displacement power factor between  $\cos(\varphi)_{\text{lagging}} = 0.90$  and  $\cos(\varphi)_{\text{leading}} = 0.90$ .

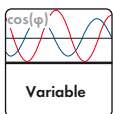

##### b) Dynamic specification of the reactive power by the grid operator

The grid operator defines the dynamic displacement power factor – as any value between  $\cos(\varphi)_{\text{lagging}} = 0.90$  and  $\cos(\varphi)_{\text{leading}} = 0.90$ . The value is transmitted via a communication unit, the SMA Power Reducer Box performs the evaluation

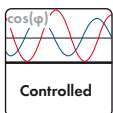

##### c) Control of the reactive power via a characteristic curve

The reactive power of the displacement power factor is controlled by a pre-defined characteristic curve – depending on the active power fed into the grid or the line voltage.

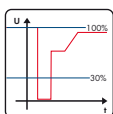

#### Dynamic grid support

The inverter remains connected to the grid during a voltage dip that lasts for up to 1.5 seconds and supports the grid by feeding in reactive current. The inverter will immediately resume normal feed-in operation once the voltage exceeds a defined minimum threshold.

<sup>1</sup> Parameters in accordance with the medium-voltage directive of the German Association of Energy and Water Industries (BDEW)



# System costs in the spotlight

Cost reduction through a holistic view of PV plants

The feed-in tariff requirements for photovoltaics vary widely throughout the world and are subject to frequent changes. In general, however, the following applies: For photovoltaic power generation to be affordable at any given location, the generation costs must be sufficiently low. In most cases, continuous cost reduction is necessary in order to absorb the periodic reduction in feed-in tariffs. Only considering the specific costs of the PV plant or inverter is not enough, however. What is needed is a holistic view of system costs.

The term "Total Costs of Ownership" or TCO refers to an accounting method that not only considers original costs, but also all aspects of a PV plant that will likely be used for a period of 20 years or more. Such aspects include planning and installation costs, maintenance and repair costs as well as system efficiency. The PV system technology of SMA helps significantly reduce the TCO in almost all areas - from planning and installation to maintenance and operation.

## Flexible planning

A wide selection of products that covers almost all power classes leads to lower planning costs for PV plants. The right inverter solution can be found for any application – regardless of whether it involves a 5 kW residential system in Germany, a 10 MW PV farm in France or a 60 kW stand-alone power supply system for a village in central China. The plant designer can access different inverter topologies (with or without transformer, single-phase/three-phase), use almost any kind of module and deploy customized solutions for PV plant monitoring. Thanks to the Optiflex asymmetrical multi-string concept, the three-phase Sunny Tripower also offers a unique level of flexibility when it comes to generator configuration. Retailers can also benefit from the fact that almost all devices can be used anywhere in the world. Logistics, warehouse storage and service are greatly simplified which leads to a further reduction in costs.

## Easy installation

Installing PV plants is all about installation time and hence costs. System technology that is both easy to use and manage can lead to a significant reduction in installation costs. The standard DC connection system SUNCLIX, for example, allows the customer to install PV cables in less than five seconds and without tools. The enclosure of the Sunny Tripower comes with a slot for type 2 surge

arresters so that they can be automatically integrated into the inverter monitoring system. All inverters in the low to medium power classes can also be linked with *Bluetooth* to suitable query devices via *SMA Bluetooth*. A powerful PV plant monitoring system can be set up in no time that not only allows access to all operating data, but also the configuration of devices. The time and cost-intensive installation of communication cables can now be omitted.

## Maximum reliability

PV plants are designed to generate power – ideally for more than twenty years since any malfunction leads to yield loss. With its unique test center, SMA can make sure that errors are excluded as early as the development phase and that all components can function under extreme operating conditions. There is even a separate test center for large-scale PV plant technology.



Country-specific configuration in the blink of an eye: Rotary switch on the Sunny Boy 5000TL



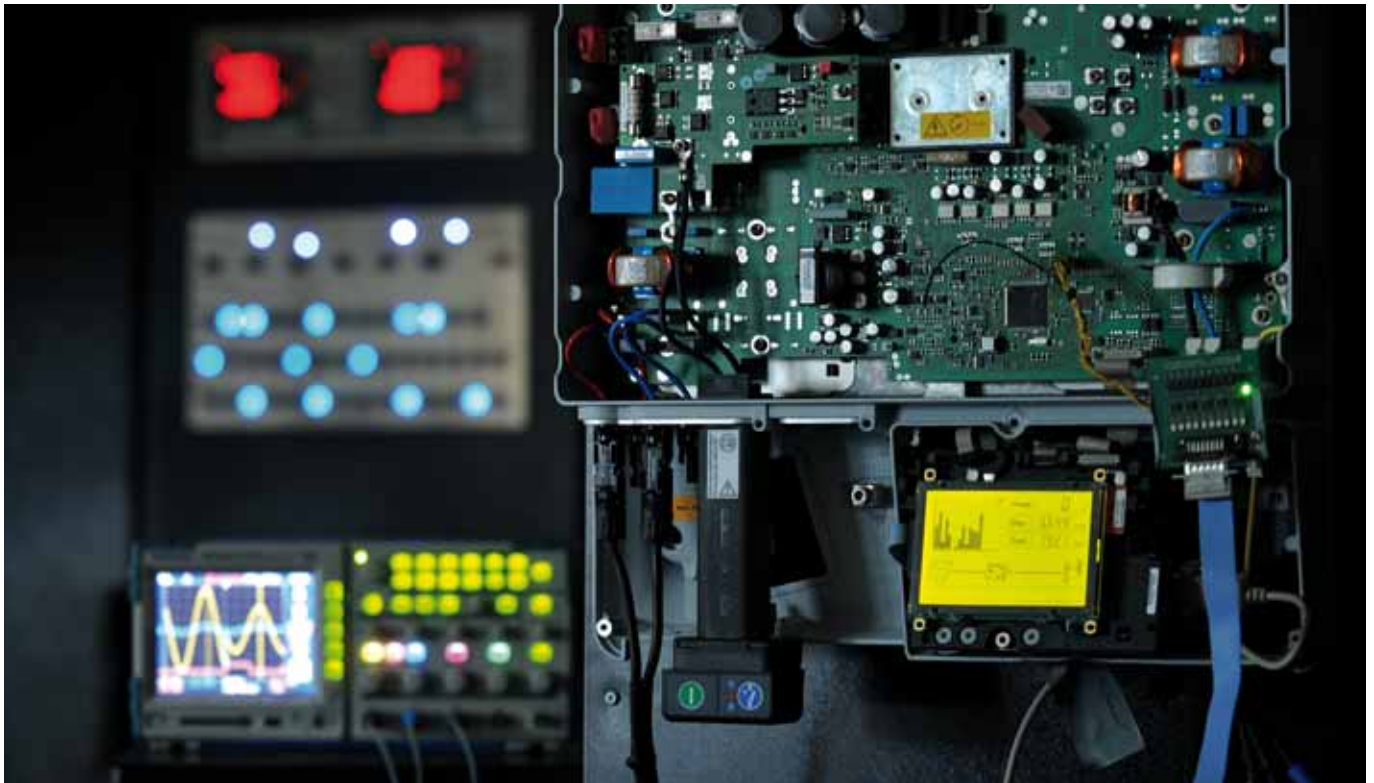

To the test: Inverters in the SMA test center

In this center SMA engineers test central inverters with capacities reaching 800 kW under all climatic conditions and can simulate any conceivable generator or system configuration. In addition, the “SMARt Flow” production concept developed by SMA guarantees a streamlined and thoroughly traceable production process that meets the highest quality standards. The result: Low maintenance costs and maximum reliability of the PV plant.

### Highest efficiency

A high efficiency, which marks the peak of technical feasibility, is one of the hallmarks of all SMA inverters. Throughout the entire service life of your PV plant, our inverters will generate significantly higher yields than cheaper inverter models, which more than makes up for the higher purchase costs. The high efficiency is made possible through innovations such as the patented H5 topology or intelligent add-on functions such as the OptiTrac Global Peak MPP tracking system, which was specifically developed to deal with partial shading. The OptiCool enclosure concept and the new power management system for SMA central inverters contribute to these optimum values.

### Intensive research and development

As a technology leader, SMA is also working on using the technological potential as a means of lowering costs. Possible approaches include the greater use of high-frequency technology, but also the further integration of components and general reduction in the number of components: All coil items (coils, chokes, transformers) can be designed to be more compact, lighter and more affordable with higher frequencies. A reduction in the number of components makes purchasing more affordable, has a positive effect on manufacturing complexity and also lowers the risk of errors.

Even a minor improvement in efficiency brings a variety of positive effects: In addition to greater yields for the plant operator, improved efficiency also leads to a reduction in heat load, which in turn may lead to smaller heat sinks and a more compact enclosure. This can also have a positive effect on the enclosure price, and also transport and logistics costs.

The success of our ongoing research and development work is clear: over the last 30 years every new generation of SMA devices has proven to be more powerful and more affordable than the previous one. The stated goal of SMA is to halve system costs by 2015 – and more than 500 developers at the company are working to achieve that goal.

### **System technology for large-scale PV plants**

The SMA TL Grounding Solution is a concept that allows significant yield increases in decentralized large-scale PV plants based on thin-film technology. In the past it was almost always necessary to operate thin-film PV modules with a ground connection, and therefore with transformer inverters. The TL Grounding Solution now allows using highly efficient transformerless inverters. If we compare the efficiencies of the best inverter with transformer (SMC 7000HV-11) and the best transformerless inverter (STP 2000-TLHE-10), we see a lasting increase in yield by more than three percent, since the TL Grounding Solution operates nearly loss-free.

Most thin-film PV modules must be grounded to avoid irreversible damage from TCO corrosion. In decentralized large-scale PV plants, each individual substrating cannot be grounded, since different array voltages may lead to equalization currents between individual inverters. The TL Grounding Solution solves this problem by implementing an intermediate DC voltage source that steps up the potential of the neutral conductor within the system by approximately 500 volts. Therefore, the modules no longer have a negative potential against ground. Corrosion is thus reliably prevented. The additional 500 volts of direct voltage are limited to the plant by the galvanic isolation of the medium-voltage transformer.

### **System technology for off-grid power supply**

AC-coupled hybrid systems are now more affordable than pure diesel-based power supply systems: They not only benefit from the low-cost AC power components and consumers available anywhere in the world, but also from the continuously declining costs for renewable power generation. Long-term savings are also achieved through the predominant use of renewable energy sources: Both the fuel costs and maintenance costs of a diesel generator are drastically reduced through the use of hybrid systems. Other cost advantages arise from the module design of the PV plants with SMA multicuster technology: Systems with 5 to 300 kW capacity can be planned with great flexibility, expanded at any time and easily maintained by local service technicians. Even the transport of relatively small components to often times distant and remote installation sites is much cheaper. All in all, PV-supported hybrid systems from SMA are not only more environmentally safe and convenient than conventional solutions, they can also boast a lower TCO.



# Sunny Tripower TL High Efficiency

World champion in efficiency with silicon carbide

With the Sunny Tripower 20000TL High Efficiency, SMA launched the first inverter with silicon carbide circuit breakers achieving the 99 % efficiency mark for the first time in a series device. By consistently focusing on the most important aspects, this inverter is also lighter and better value for money than the standard version of the Sunny Tripower.

## **Energy efficiency through technological progress**

Silicon carbide (SiC) is considered a material of the future in the power semiconductor business area due to its lower switching losses. However, it has only been used for PV inverters in free-wheeling diodes and in research and lab projects. Two reasons for this are the comparatively higher costs and the entirely different switching behavior of the SiC elements, which require a completely new design for the power modules and a modified regulation and control procedure. SMA has tackled this challenge and developed the Sunny Tripower 20000TL High Efficiency, the first PV inverter based

on SiC semiconductor switches and ready for series production. In addition to the accelerated service life testing in the in-house testing center and more than one year of field testing, the close cooperation with semiconductor and power module manufacturers has also contributed further to this success.

The Sunny Tripower 20000TL High Efficiency, which was launched at PVSEC 2011 and has been on the market since the spring of 2012, features more than 99 percent efficiency, a feat previously unseen in series production devices; however, its exemplary energy efficiency is virtually independent of the the input voltage and current output.

The European weighted efficiency (Euro-Eta) is likewise as high: at 98.7 percent, it is nearly one percent higher than the PV inverters on the market now. Since the maximum power loss was reduced by one third despite the increased nominal power, the enclosure volume and ventilation concept have remained unchanged compared to the Sunny Tripower 17000TL. And despite the fact that the 20 kVA system features the same high-quality full-metal enclosure

providing maximum safety, its weight has been reduced by nearly 12 kilograms.

### **Cost-effective thanks to a compliant design**

In addition to continuing to develop the inverter bridge technology, SMA is pursuing a further strategy with the Sunny Tripower 20000TL High Efficiency that fulfills customers' requirements for large-scale PV plants to the fullest: Consistently reducing components to the minimum to increase cost effectiveness. The system is equipped with a reverse current diode for three substrings each, which also provides reliable protection against reverse currents, instead of an electronic string fuse.

If there are no requirements for reverse current protection on the module, the diodes can be bypassed and the maximum efficiency increases to 99.15 percent from 99 percent. Even the single-phase inverter topology has a positive effect on the specific costs and efficiency. The newly developed B6 bridge regulation concept broadens the MPP input-voltage range to 580 – 800 volts, a noteworthy value for designing plants in the Commercial segment, which are generally homogenous, or for decentralized PV power stations.

### **Double your benefits and secure a long-term reduction of system costs**

By using SiC semiconductors in the inverter bridge, developing an intelligent regulation concept for expanding the MPP voltage window, and offering equipment that is precisely designed for the system requirements in the application area, the Sunny Tripower 20000TL High Efficiency is attractive in two respects: on the one hand, the increase in efficiency to 99.15 percent, which results in higher yields over the entire electrical endurance of the system and a feat which no other device in series production has yet attained. And also by the significant reduction of the specific price which was possible despite the higher material costs of the silicon carbide semiconductor. In addition, the inverter features 18 percent more power and 31 percent less performance weight.

SMA also makes a decisive contribution to sustainably reducing the PV system costs with the development and market launch of the first inverters with SiC semiconductor switches ready for series production, independent of the direct advantages for plant operators.

Because further progress in energy efficiency, cost effectiveness, and power intensity are future possibilities, especially when based

on this technology. The possible series production of the PV inverters based on SiC provide a vital push in the right direction and support the creation of the necessary economies of scale.

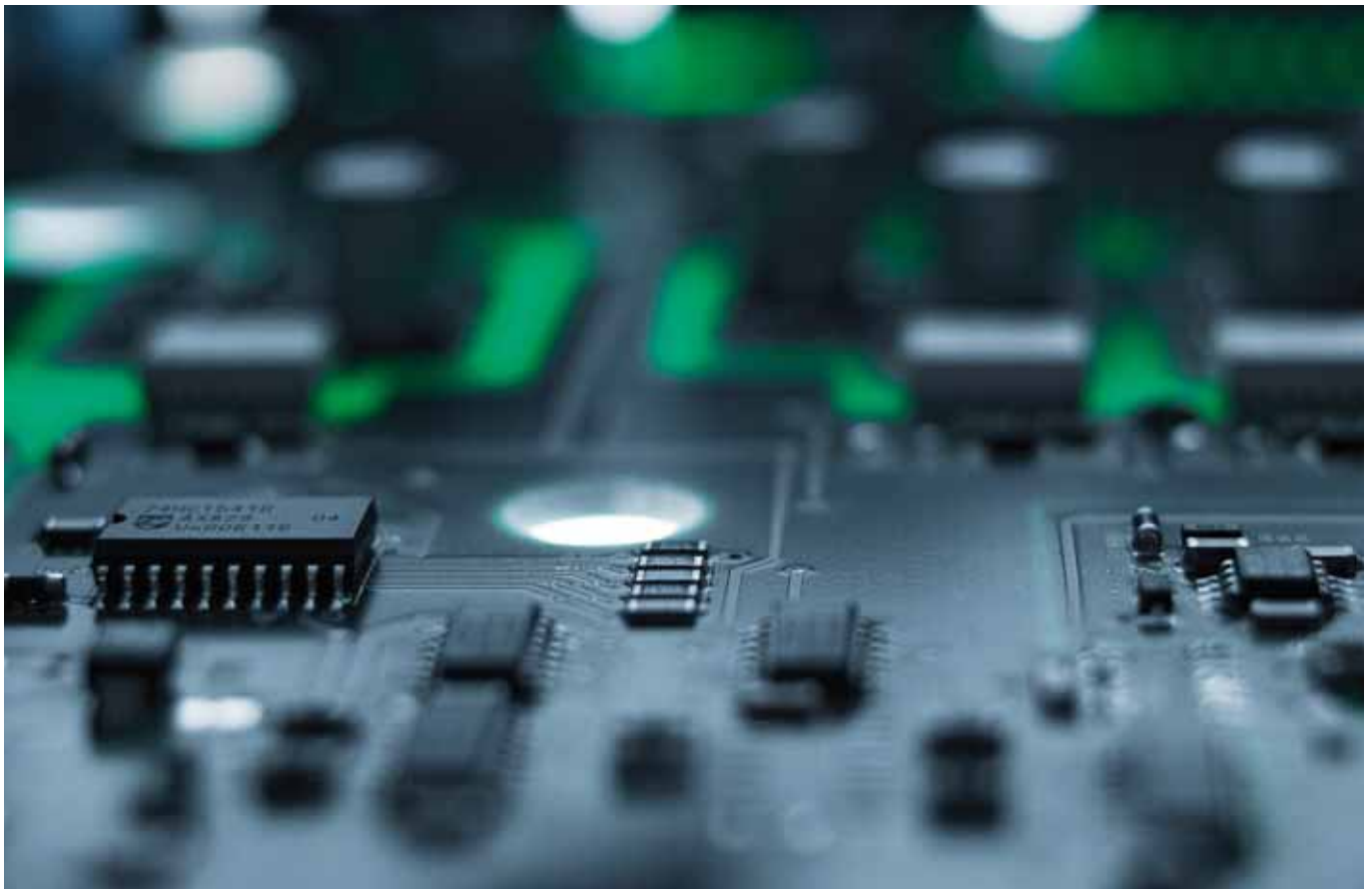



# Intelligent error management

Optiprotect troubleshoots and minimizes yield losses

PV power stations are continually increasing in size and power. Power plants in the two or three-digit megawatt range are no longer the exception, they are the rule today. It is becoming easier and safer to plan, install, and operate these large-scale PV plants using high-power inverters and optimized medium-voltage components. However, the number of potential string failures caused by time-related events and continual errors increases as the size of the PV plant increases.

Optiprotect is SMA's solution for inverters of the Sunny Central CP series, providing a comprehensive and centralized safety concept anchored in the inverter, one that can reliably detect, evaluate, and troubleshoot all potential errors in the module field. Optiprotect can monitor both time-related impairments and continual errors.



An intelligent algorithm enables the program to reliably detect errors after an initial learning phase. It measures and analyzes the behavior of all strings. It differentiates reliably and automatically between time-related events such as shading caused by leaves or snow and serious errors such as short circuits. This prevents service technicians from having to answer calls unnecessarily and they only need to deal with alarms detecting genuine, continual errors.

Optiprotect can disconnect the substring affected by the defect from generating electricity in general by automatically detecting string failures. There are a total of 16 motor-driven circuit breakers over which a maximum of 1600 grouped individual strings run in the inverter's DC input range. The detected errors are reported via Sunny Central Communication Controller, the data logger preinstalled in the central inverters, which forwards them to the control room.

The PV power station continues to generate electricity even after a substring is disconnected. This action prevents the entire plant from being disconnected. The plant operator can continue to expect to attain the highest yields possible. An additional advantage is the fact that the communications cabling and the string monitor boxes are not required in the module field because the technology is centrally located in the inverter. The SMA String-Combiner can be used to combine the individual strings in the module field in a secure manner.





# Sunny Home Manager

Comprehensive energy management in the household

SMA is the first manufacturer to offer the Sunny Home Manager as an energy management system that can intelligently plan the automatic load control and at the same time can also include local storage and usage of the time-dependent rates for purchased electricity.

The management of energy flows including self-consumption and integration of storage systems are essential issues for the integration of increasing PV power into the existing power distribution grid.

One first step was the introduction of incentives in the German Renewable Energy Sources Act for a better time-dependant coordination of power generation and consumption. In the long run, further actions are necessary that finally result in the well known "smart grid" and "smart home" concepts. The long-term goal for an energy system based on renewable energy sources is the intelligent and flexible control of all energy flows together with an optimization of these energy flows on household and distribution grid level.

## **Optimization on household and distribution grid level**

Optimization on household level includes the use of as much solar power as possible on-site – right in the moment of generation or later, provided that a storage system is also available. The self-consumption of solar power from a rooftop PV plant relieves the power distribution grid because the solar power replaces power from the power distribution grid that would otherwise need to be transported to the location. Similarly, the solar power generated there does not need to be transported to anywhere else. This is one reason why the self-consumption of solar power has been subsidized through the German Renewable Energy Sources Act since the beginning of 2009.

The distribution grid level can be optimized in a similar manner. But here, too, it is a matter of matching the time-related fluctuations in generating and consuming the power, whereas the power to match the demand is increasingly being supplied by the raising portion of power generation capacity from renewable energy sources. A prerequisite for optimization on the distribution grid level is a variable price for purchased electricity that reflects the current ratio between the power generation capacity and the load power in the power distribution grid and serves as an indirect control value for power consumption. A sufficiently large number of energy management systems that can take into account a variable price for purchased electricity is needed to optimize the amount of energy on the distribution grid level, in addition a precise forecast of the expected PV power on the distribution grid level.

For this reason, the following requirements apply to a complete energy management system at the household level:

1. The ability to automatically switch the consumption loads in the household
2. The ability to take into account local forecast data on solar irradiation and on energy demand
3. The ability to store any solar power and use it at a later point in time
4. Takes time-of-use electricity rates into account

### **The SMA system solution**

The Sunny Home Manager is the first product solution to fulfill all four of the listed requirements. As an intelligent control interface, it is responsible for the optimization of the energy balance. The user can select whether a solely local optimization is desired (maximized self-consumption of solar power) or an additional optimization on distribution grid level is to be implemented (consideration of time-dependant electricity rates). The Sunny Home Manager controls the switching of loads using a special SMA *Bluetooth* controlled socket. It is also prepared for future communications standards in building automation. This allows the direct

control of devices that are equipped with the respective data interfaces; Miele, a household appliance manufacturer in Germany, agreed to cooperate with SMA in this respect in 2011.

### **Additional functions**

The integration of the Sunny Backup system S provides an efficient and flexible energy storage unit, where the device is also controlled via *Bluetooth* technology. In addition to the backup functions, it can also be used to buffer solar power and increase the self-consumption quota even more.

A unique selling proposition of the Sunny Home Managers is the option to use local weather forecasts with short-term resolution of 60 minutes. Additional input variables such as the current production and load power, the battery state of charge, as well as stored load profiles of the household and controlled loads provide the device with the necessary information to meet the targets of intelligent energy management according to the user's specifications.



### Design and function of the system

The Sunny Home Manager starts by analyzing the data from up to three electricity meters (PV generation, grid feed-in, purchased electricity) and can keep exact track of the relevant energy flows in the home. It only activates the controllable loads when the current PV power sufficiently exceeds the current consumption in the home. The additional and unintentional need for purchased electricity can be avoided as much as possible, in contrast to many other solutions for increased self-consumption. The decisive advantage of the Sunny Home Manager is its intelligent planning capability. The decision to activate a load cannot always be a spontaneous one: The sun might only be disappearing behind the clouds for a minute, yet the washing machine will run for another 90 minutes. The switch-on time can be freely chosen for some loads, but not all. Some devices can be switched on and off at leisure, whereas others have a minimum run time.

But it is a fact: Energy management reaches its limits rather quickly in a home without intelligent planning.

### Broad database

The Sunny Home Manager is the first product on the market that is capable of performing these planning tasks. For one, it continually receives local 24-hour weather forecasts. For another, it calculates the average household load profile based on the past electric meter data. This means that the device knows within a certain probability how much electricity is needed and when. The SMA radio-controlled sockets for the individual loads also feature a measurement function to enable the specific load profile of the washing machine, for example, to be integrated into planning. The difference between the load profiles measured by the SMA radio-controlled sockets and the total value for the entire household (based on the electric meter data) is yielded by the "basic

① **Sunny Home Manager**

As central energy manager, the Sunny Home Manager analyzes various input parameters and provides for optimal timing of power generation and consumption.

② **Sunny Portal**

The Sunny Home Manager is operated and configured via the Sunny Portal, which can be accessed using any Internet browser. The live display of all energy values provides further incentive to save energy.

③ **SMA Bluetooth radio-controlled socket**

Appliances that are not on a fixed schedule can be activated via the Sunny Home Manager at just the right moment via up to ten radio-controlled sockets.

④ **Electricity meter**

Up to three electricity meters can be connected to the Sunny Home Manager via SO or DO interfaces. As a result, the device keeps tabs on all energy flow in the home. The digital interfaces provide particularly high-precision timing.

⑤ **Sunny Backup-system S**

The Sunny Backup system provides for temporary storage of solar power and also offers a grid-quality power supply with protection against outages.

⑥ **Power distribution grid**

The load on the grid is reduced through self-consumption, because the household needs less energy and at the same time does not have to feed as much solar energy into the grid. If a lot of power is available in the grid, the Sunny Home Manager can also take this into account in controlling appliances, thus further reducing the costs of drawing grid power.

⑦ **Controllable appliances**

Washing machines and dishwashers, as well as heat pumps and hot-water tanks are not tied to particular switch-on times. For intelligent load management, the Sunny Home Manager can activate them by remote control – depending on the current level of solar power generation or the current price for electricity.

⑧ **Non-controllable appliances**

Stoves, TVs, computers, and many other appliances are not controlled by the Sunny Home Manager. However, appliance control planning does automatically take their typical switch-on times into account.

load profile” of the home, which is vital for planning, i.e., the average energy demand without including the controllable loads.

### Flexible resource planning

An intelligent planning algorithm develops the optimum roadmap for the controllable loads based on the available information. This roadmap is not set in stone. It is recalculated each time the basic conditions change. And the controllable loads can also be individually configured (for example, the latest possible end time for the washing machine) and manually activated at any time.

### Operation and data analysis

The device is operated and configured online via the SMA Sunny Portal, and current load, forecast, and planning data is displayed there as well. It can be accessed from anywhere with any Internet-capable device. Since the Home Manager includes all the

standard plant monitoring functions of the Sunny Portal, there is no need to add another Sunny WebBox.

### Comprehensive product solution

SMA offers a comprehensive and intelligent solution for the ever important topic of energy management at household level with the Sunny Home Manager. At the same time, the company continues to maintain its focus on future energy optimization on the distribution grid level. The device is more than a simple, power-controlled switching device for a reason. It provides a significant contribution to grid integration of additional PV power and the establishment of a future smart grid.

### Information

Consult the SMA Innovations Catalog for the Sunny Home Manager product page including the exact technical data.





# SMA multicluster technology

The path to your own power grid

Off-grid systems on AC basis open up new possibilities for providing a stable and powerful energy supply which is entirely independent of the power distribution grid. This kind of stand-alone power grid not only provides the customary supply quality usually associated with large power distribution grids. Due to its modular structure, it is also

very simple to install and can be expanded as required. Through the integration of renewable energy sources which avoid fuel costs and at the same time are becoming ever more efficient, such systems are today more cost-effective than conventional systems running on diesel generators.

## 1. Why alternating current?

So-called AC coupling forms the basis for modular off-grid power supply with capacities of up to 300 kW. In contrast to DC coupling, all energy sources and loads are connected through an AC power grid, which offers a number of advantages: Commercial and therefore affordable AC power devices can be used on the consumer side. On the generator side, any kind of renewable or conventional energy sources can be incorporated. Alternating current grids can be expanded without specialized expertise and using standard components that are available everywhere. Compared to components for direct current grids, these components are considerably cheaper because they normally have to carry higher voltages but also much lower currents. There is also much more planning flexibility involved since even large distances between the generators, batteries and consumers can be implemented. Moreover, the connection of generators and consumers of alternating current grids is possible practically at any random point in the network – thus providing optimum conditions for subsequent expansion.

## 2. Sunny Island – the grid and battery manager

The central component of the stand-alone power grid is the Sunny Island battery inverter. In its role as grid former and manager, it maintains the stability of the AC grid and ensures that voltage and frequency remain within the permissible limits. The Sunny Island is a bidirectional battery inverter and is often referred to as a combined inverter/battery charger. Thus, it is a bidirectional battery inverter, often referred to as a combined inverter/battery charger. Such devices are particularly cost-effective, since they execute both functions via the same power semiconductor devices.

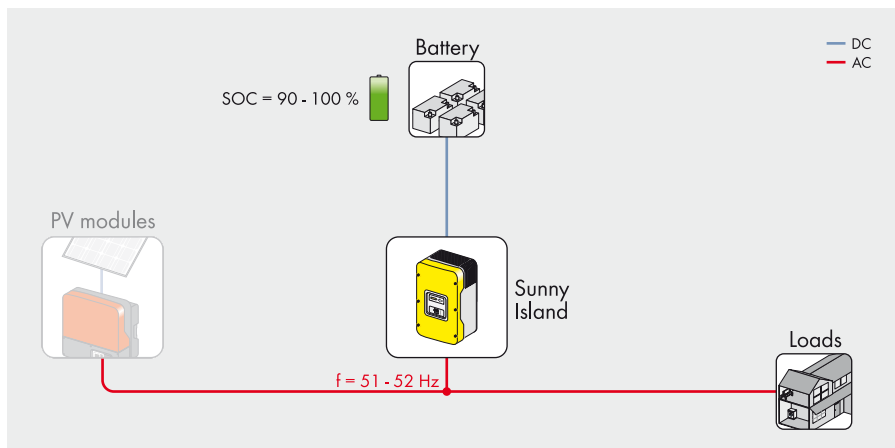
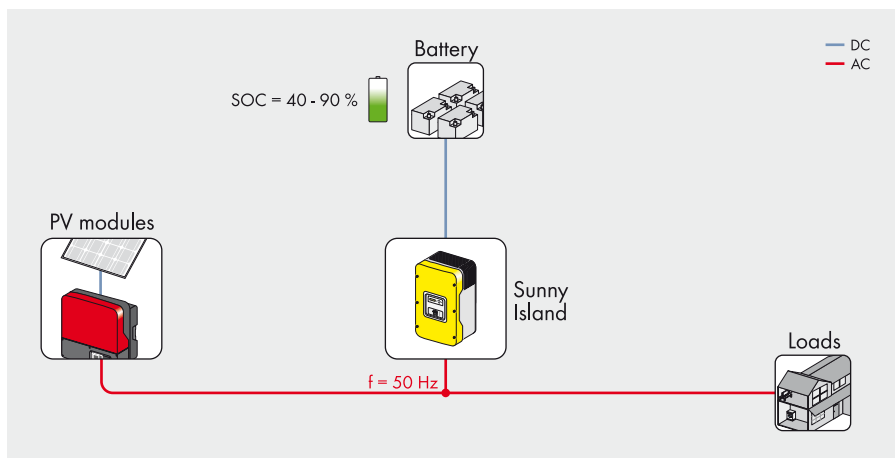

At a state of charge under 90 percent, power surpluses can be absorbed by the battery at any time. When the battery is fully charged and power surpluses are produced, the Sunny Island increases the AC frequency. The generators then continuously reduce their power.



The Sunny Island is equipped not only with grid management, but also with a highly developed battery management function, including monitoring. Thus it is continuously updated on the batteries' exact state of charge and as system manager makes ongoing decisions. At times when the batteries are empty and there is little generation capacity, it can activate a permanently available backup energy source (e.g. a diesel generator) or even switch off certain consumer loads. It also determines the optimum strategy for charging the batteries, and in doing so, increases their lifespan. Apart from all this, the compact device provides further special functions specifically geared to the requirements of stand-alone power grids.

#### **Automatic reactive power compensation**

With a possible phase shift of  $-90$  degrees to  $+90$  degrees (shift factor  $\cos(\phi)$  from 0 to 1 lagging/leading), the Sunny Island can, if necessary, provide its entire nominal power in the form of reactive power. Thus, it is capable of compensating for phase shifts in the stand-alone grid caused by lagging or leading loads (e.g., engines, transformers, cable lines).

#### **Remote control PV management**

When the batteries are full and electricity demand is low, the Sunny Island reduces the electricity produced by all renewable energy generators – whether PV plants, hydropower or wind turbine systems. Sole proviso: All the inverters must be SMA devices and their stand-alone grid mode must be activated. If this is the case, the devices will no longer disconnect from the grid with rising frequency, but will continuously reduce their power output. As grid manager, the Sunny Island specifies the frequency in the stand-alone grid and can thus limit the power of all the generators and maintain the energy balance of the grid – without any further lines of communication.

#### **Extreme overload capability**

When certain loads are switched on, high start-up currents are frequently encountered which can be well in excess of the normal operating current. In addition, some loads may require a lot of energy just for a short while, thus creating short peaks on the load profile. For the sizing of off-grid systems, it is extremely important to use battery inverters with a high overload capacity; this will ensure that such load peaks can be handled

without a problem. The Sunny Island 5048 can handle 6.5 kW for 30 minutes, 8.4 kW for 1 minute and as much as 12 kW for 3 seconds – i.e. approximately two and a half times its nominal power.

### 3. Three phases – no problem

For the transmission of large capacities in AC grids, a three-phase configuration has proven effective – this is true both for large power distribution grids and for stand-alone grids. The advantage: Due to the overlap of the phase-shifted individual capacities, three-phase consumers have practically continuous power at their disposal. The generators in diesel power units or wind turbine systems also supply three-phase power in most cases. It is actually possible to set up single-phase systems up to a battery inverter power of 20 kW (parallel switching of four Sunny Island 5048 to one phase). For larger capacities, however, three-phase stand-alone grids are usually preferred.

This is accomplished by having three Sunny Island inverters linked into a three-phase cluster. A master device sets the frequency for both slave devices, which in turn operate exactly at 120 or 240 degrees phase-shifted from each other. Synchronization is achieved via a special communication connection between the devices. Another advantage of this connection is that the entire cluster can be configured using only the master inverter.

If the system is properly wired and configured, a three-phase stand-alone grid can function just as well as the single-phase version. An asymmetric grid load caused by a single-phase load is also automatically compensated by having the inverter responsible for the phase with the greater load draw correspondingly more power from the battery. Even completely unbalanced operation is possible, for example when solar power is fed into the stand-alone grid to phase 1 and there is consumption on phase 3. Since the energy must be put through two additional Sunny Island inverters, it is still better to keep the distribution of loads and generators as balanced as possible in order to maximize efficiency.

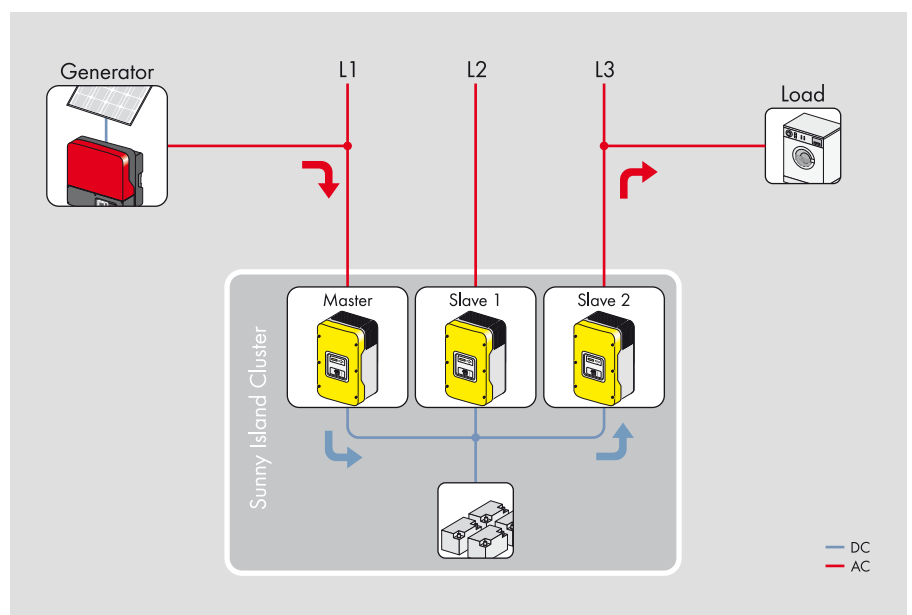

Asymmetric load on the three-phase grid is no problem



Multicluster Box 6 for max. 2 clusters

MC-Box 12 for 3...

#### 4. Multicluster technology – less expense for large systems

The special advantage of SMA's off-grid system technology lies in its modular design: PV plants of any performance class are built using comparatively small and manageable components, which makes transport and installation easy even at remote locations. By dividing the inverter capacity into clusters (i.e. groups of three devices each), the planner is extremely flexible with respect to system performance. This is almost infinitely scalable thanks to the parallel connection of multiple clusters, and a subsequent expansion of the off-grid system is also easy to implement.

Since the basic design is identical and the devices used are always the same, service personnel once trained can configure, operate and maintain plants of any size.

Besides the Sunny Island battery inverter, the core element of the modular system is the Multicluster Box which is responsible for the simple connection of all components into one battery-supported AC grid with a variety of power generators. The Multicluster Box is available in three power classes, comes fully wired and contains all of the necessary switching elements and monitoring devices. It allows the implementation of any off-grid system ranging from 5 kW to 300 kW in capacity.





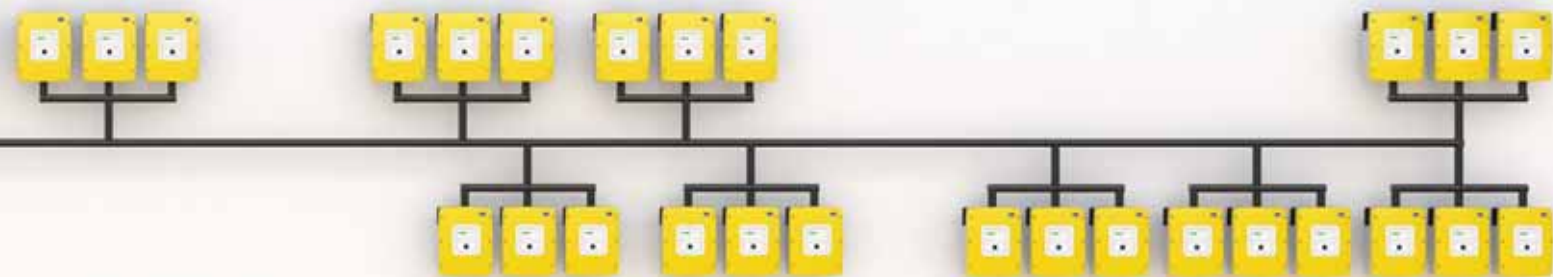

...or 4 clusters

MC-Box 36 for 5, 6, 7, 8 ...

... 9, 10, 11 or 12 clusters

### Power made to measure: The Multicluster Box

The core element of multicluster technology is the Multicluster Box which is available in three power classes. As a pre-configured AC distribution board, it enables the easy connection of all AC components in the stand-alone grid, including battery, generator, renewable-energy generation plants (e.g. photovoltaic, wind turbine or hydro-electric power), loads and two to twelve clusters, each made up of three Sunny Island inverters. The different Multicluster Box versions differ only by the number of connectable clusters and the corresponding sizing of all live components. The structure is straightforward: There are connections for each Sunny Island inverter, main connections for a PV array, the renewable power generation plant, and the loads. These latter two usually require sub-distributions which have to be planned separately.

### Multi-level security: Generator and load-shedding contactors

A power contactor is integrated into the distribution board for both load and generator connections. The generator contactor connects grid-forming generators such as those used in more powerful diesel generating plants or combined heat and power plants. In contrast to generators in grid-parallel operation, they cannot synchronize with an existing grid, and therefore in this case, the generator specifies the grid parameters. The cluster group of Sunny Island inverters adjusts accordingly, meaning the connection is established as soon as voltage and frequency with the pre- and post generator contactor are synchronized.

If the Sunny Island cluster fails or is switched off, the generator contactor closes automatically, so that the generator is directly linked to the connected loads. In the case of a generator failure, however the system rapidly disconnects and maintains supply with battery power and the available renewable-energy generators. Thus, even when one component fails, a secure operation is assured.

If a long-term generator failure occurs and the renewable energy sources are not sufficient to fully power all the loads, the energy stored in the battery will be used initially. Once a lower discharge threshold is reached, the contactor on the load side opens and unlocks the line in order to safely prevent the batteries from deep discharge and the cluster group from disconnection. Instead, the system remains active and uses all available sun, wind or hydro power to recharge the battery. The loads are automatically reconnected once the battery's state of charge is high enough. Conclusion: Even in cases of severe faults, the maximum possible power supply reliability and battery protection are guaranteed.

However load management, for instance, to avoid unnecessary load peaks, is executed by the multi-function relay of the Sunny Island inverters. In each device of the main cluster there are two relays available, to which it is possible to assign one of 17 functions via the device menu. Apart from starting the generator when the battery charge is low, it is also possible to connect individual loads via a separately installed contactor.

**Flat hierarchy: inverters in cluster groups**

In a stand-alone grid with up to 36 Sunny Island inverters, a clearly organized structure is essential to ensure effective control of the grid. As mentioned above, each of the maximum twelve clusters consists of three inverters – one master and two slaves. Each of these three-phase clusters is assigned a separate sub-battery that it controls and monitors.

In addition, one of the clusters is defined as the main cluster. The corresponding main master device controls the entire system and communicates with the Multicluster Box. The main cluster is supported by up to eleven extension clusters, each of which in turn consist of one extension master and two extension slaves. Thus, we distinguish four hierarchy levels (number of devices in brackets): main master (1), main slave (2), extension master (1 - 11) und extension slave (2 - 22).

**Measurement and control: Communication lines**

In addition to the contactors, the Multicluster Box also contains two interfaces for communication to the main cluster. On the one hand, current, voltage and frequency at the generator connection to the three inverters of the main cluster are transmitted. This data is required, amongst other things, for the synchronization of the Sunny Island cluster to the generator. For tripping the contactors, the Multicluster Box is also connected to the internal communication bus of the main cluster. And, finally, all the master inverters in the system are connected to each other. Through the multicluster bus, information is transmitted about the current cluster power, battery charge and the nominal frequency.

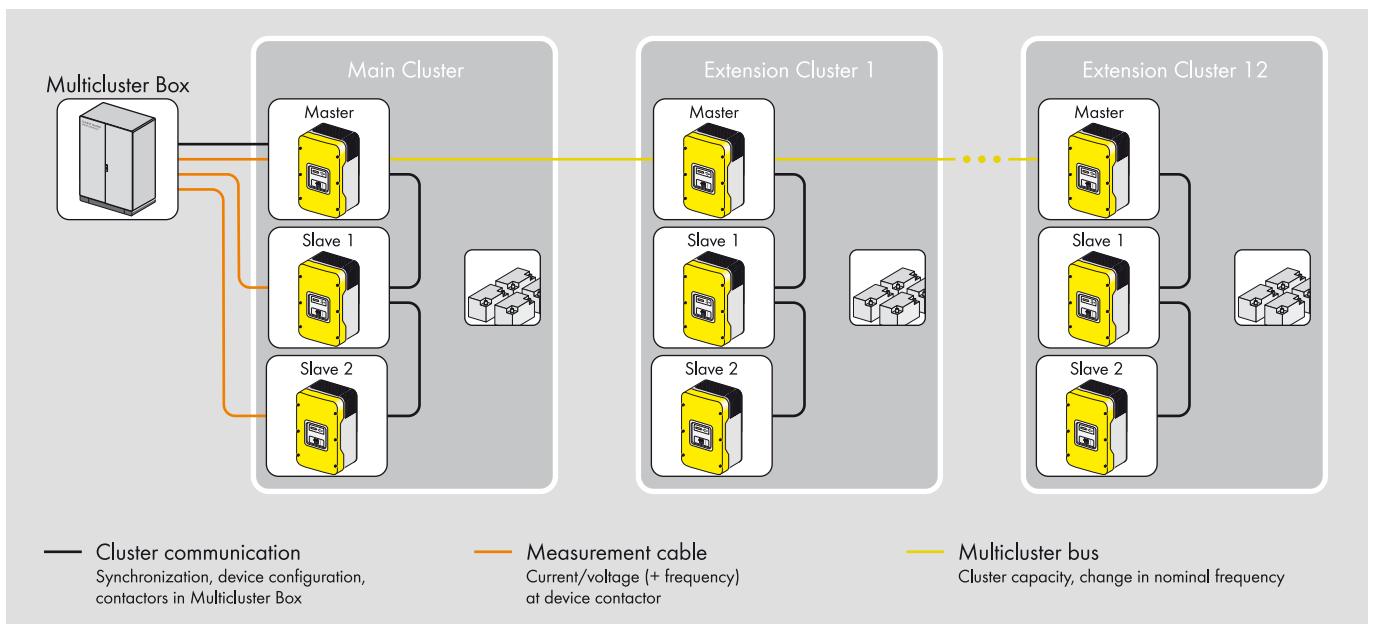

The structure of the modular multicluster system with the required communication connections



### **Flexible in normal operation**

The modular design of off-grid systems offers an amazing degree of flexibility that provides advantages not only in terms of planning, but also for system expansion and maintenance. The modular design makes it easy to incrementally expand and upgrade any small system. Additional clusters can be connected to Multicluster Box at any time so that the capacity of renewable energy generation can be expanded in accordance with demand. The only limiting factors are the number of Sunny Island connections possible on each Multicluster Box and the ampacity of their switching devices (see the technical data for the Multicluster Box).

In fact, the availability of the entire system is also enhanced by the modular structure based on compact standard devices. With the exception of the main cluster, maintenance or replacement of individual Sunny Island inverters can take place during system operation – the only difference being that the total power of the system is correspondingly lower during this time. The same is true for the individual sub-batteries

that are assigned to the various Sunny Island clusters. The intelligent battery management of the cluster group ensures all battery segments have regained the same charge within a very short time.

### **Easy maintenance by local service technicians**

The only regular service work necessary on Sunny Island inverters is the cleaning of the ventilation grid. The individual battery units must be serviced once a year. Due to the protective low voltage used on the DC side, this work can also be performed without any specialized knowledge and during normal operation. In case of failure of a Sunny Island inverter, every service technician trained by SMA is able to carry out device replacement. And in the even more unlikely case of an error in the Multicluster Box, remedial action involves little effort. Instead of replacing the cabinet as a whole, it is sufficient to have a service technician replace the affected component on-site.



## 5. The Island Solution – modern electricity supply on Eigg Island

An example of a high-performance, off-grid power supply system can be found on Eigg Island. The island is part of the Scottish Hebrides, about 30 km<sup>2</sup> in size and with a population of 90. The island has yet to be connected to the power distribution grid from the mainland, which is about 16 kilometers away. The costs are simply too high. Until 2008 the island was supplied with electricity by diesel generators. This form of power supply was always very expensive. On top of this, there were disconnections at night due to the noise pollution and all electricity had to be switched off when maintenance work was required.

### A power grid of their own

Since 2008, the islanders have been reaping the benefits of a modern three-phase electricity grid, 95% of which is supplied by renewable energy sources. This hybrid off-grid system uses three renewable sources integrating hydroelectric, wind and photovoltaic power, and only uses a backup generator at times of poor generating capacity. Although electricity is now available 24 hours a day costs for the residents have fallen by more than 60 percent. The central element

of the stand-alone grid is the group of four Sunny Island clusters which is connected to various generators and loads via a Multi-cluster Box 12: Three water turbines with a total of 110 kW, four small wind turbines with 24 kW and a PV plant with 31 kW peak power ensure a supply of environmentally sound electricity. Thus, the Sunny Island inverters with 60 kW nominal power face a power generation capacity from renewables of around 144 kW. This power ratio is typical for off-grid systems since the maximum capacities of different generators are only rarely available at the same time. Two diesel generators with 64 kW nominal power each serve as backup in case the renewable energy source is deemed insufficient. However, only one of the generators is ever in operation at any one time, so that the system can switch over to the other generator during maintenance work or troubleshooting. The battery bank has a storage capacity of 212 kWh – this alone can keep the island supplied for around twelve hours. In order to avoid transmission losses resulting from the distance of several kilometers between loads and generators, the local power distribution grid operates partially at a medium-voltage level of 11 kV. Locally generated power further relieves the distribution grid, as some of the energy produced is consumed directly in the vicinity.

### Operating principles

In normal operation, the main master of the Sunny Island inverters controls the entire grid and ensures that the energy balance is equalized at all times. When the generated power from renewable sources exceeds the current demand (15 kW to 60 kW), the surplus is stored in the battery. When the battery is fully charged, the main master starts to increase power frequency by a small amount. This activates on the one hand remote-controlled electric room heating in public buildings. On the other hand, the renewable energy generators carry out a frequency-controlled reduction of their capacity. If the power generated from renewable energy sources is not sufficient, the 60 kW power of the Sunny Island inverters is available for support; this energy will be taken from the battery.

The main master will only start the diesel generator when the state of battery charge falls below 60 percent. In this case, the power frequency is preset by the diesel generator and the Sunny Island clusters are synchronized to their grid parameters. At the same time, they continuously keep the energy balance stable. When large loads are activated or deactivated, the load on the generator is not changed immediately – the inverters are able to compensate the load fluctuation by instantaneous changes of their charge or discharge current. An important contribution is made by the enormous overload capacity of the devices: for three seconds, they supply 144 kW of battery power to the grid.

In its role as grid manager, the main cluster weighs up the alternatives of operating the diesel generator with the highest possible efficiency, and charging the battery with the appropriate charging current (the charge state also plays a role in this equation). As a result, the generator runs less frequently on inefficient partial load and is burdened less with unnecessary, short start/stop cycles. Incidentally, since sudden load changes are absorbed by the Sunny Island inverters, those generators which only have a low power output in relation to the consumer loads can also be operated safely.

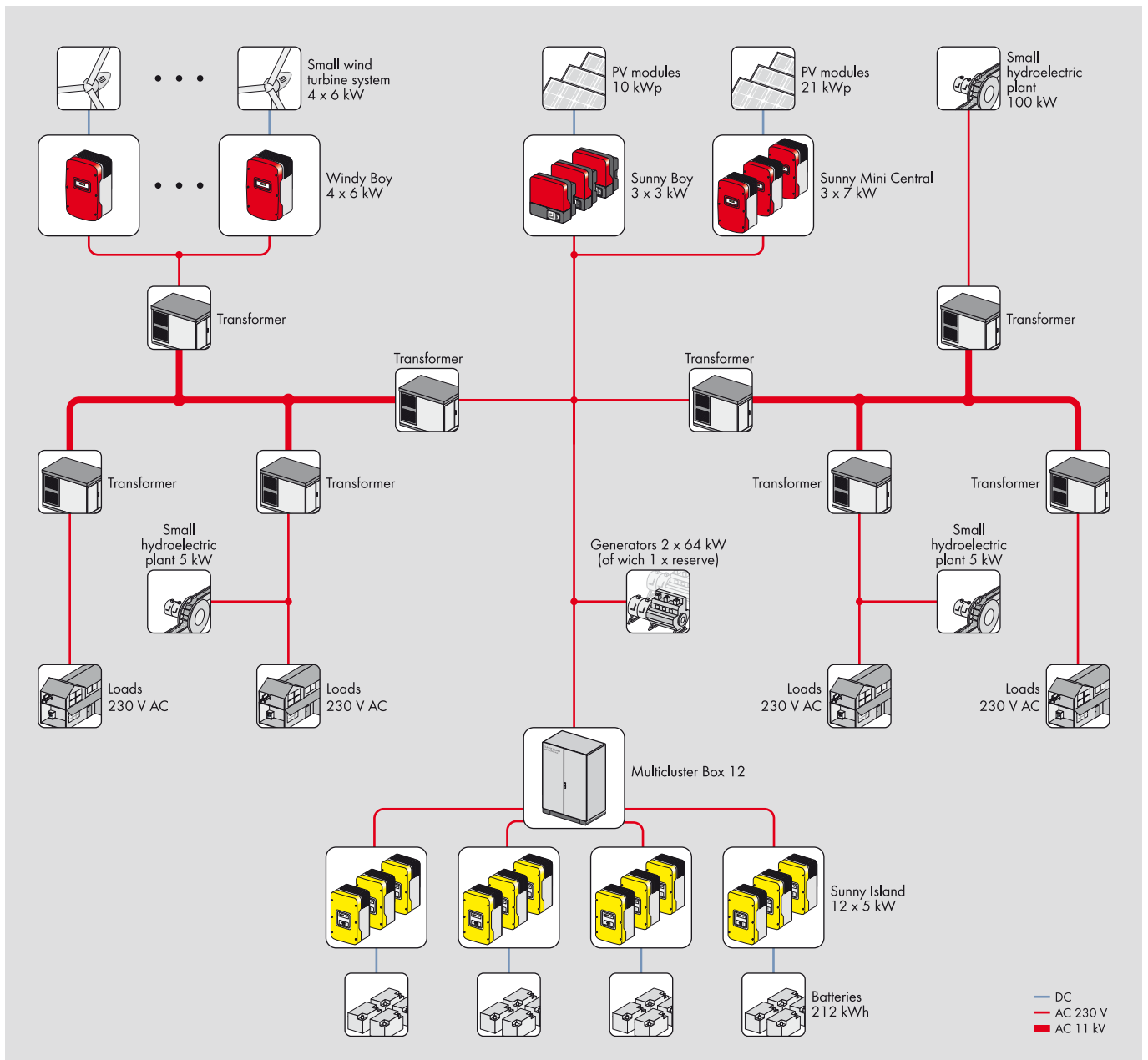



# REFERENCES





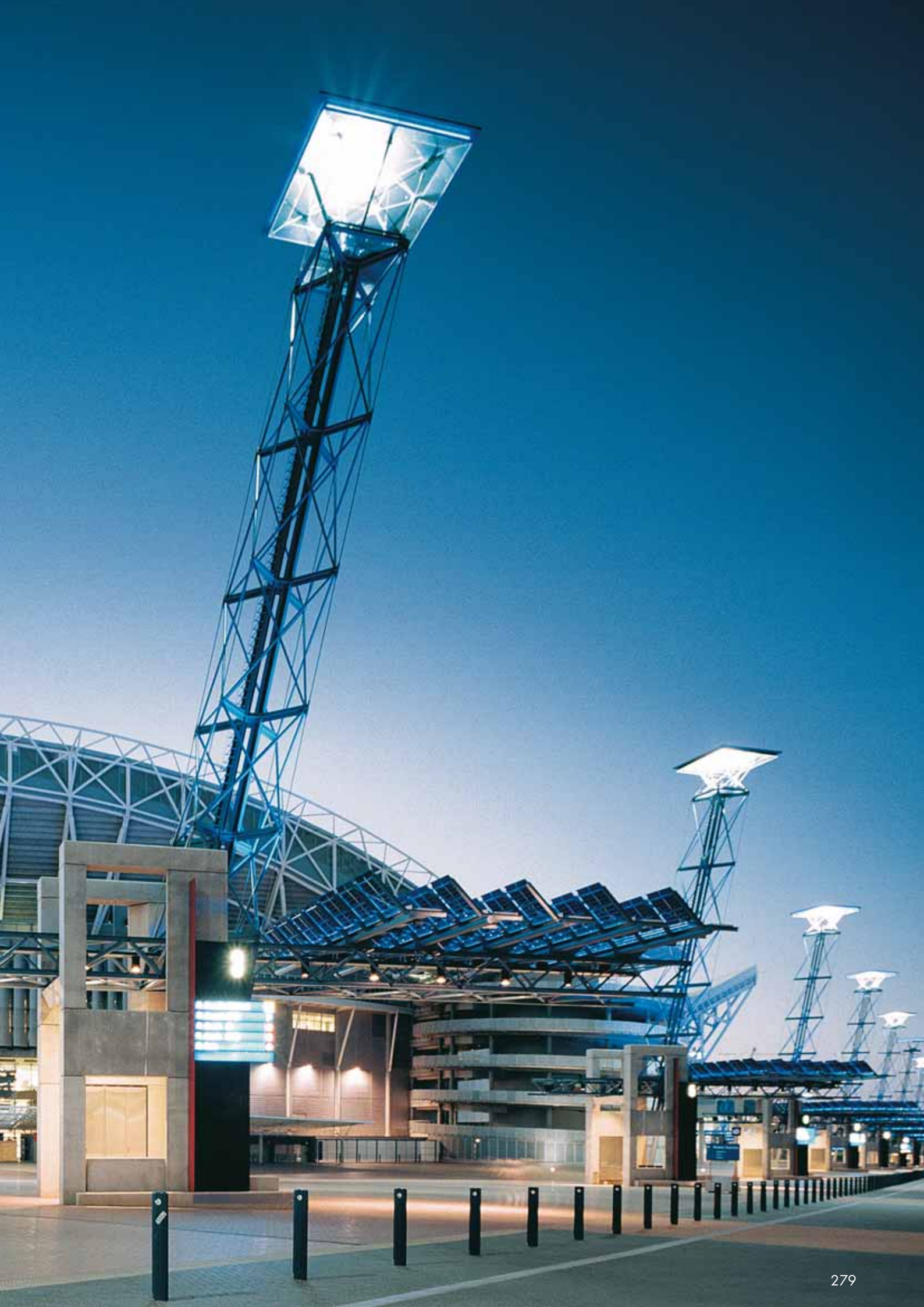



# PV plants

The appropriate inverter for every application

The future belongs to renewable energies. Fossil fuels such as oil and coal are finite resources, and damage the climate and the environment. Photovoltaic plants, on the other hand – with their low wear, good scalability and generation which matches consumption – are among the most effective measures for a reliable and sustainable energy supply. Not least because the solar energy in question can cover our global consumption more than a thousand times over.

On the following pages, we show several examples which demonstrate that the integration of solar power systems into the visual appearance of our cities and countryside is highly successful. These systems are not unsightly and often add to the aesthetic value of many buildings or spaces.

Photovoltaic plants are now used as the basis of off-grid systems in many corners of the world in order to set up energy supplies in remote off-grid regions, which would otherwise be unthinkable.





Top:  
**Service Center,**  
**City of Eschborn,**  
**Germany, 104 kWp**  
 SB 3000TL, SB 4000TL, SB 5000TL

Bottom left:  
**Tiber Targhe**  
**Italy, 277.5 kWp**  
 SMC 5000A, SMC 8000TL

Bottom right:  
**Pirig Solarenergie,**  
**Germany, 50 kWp**  
 SB 1100, SB 2500, SMC 4600A,  
 SMC 5000A, SMC 9000TL, SBU XL





Top:  
**Reckhahn PV farm,**  
**Germany, 37.80 MWp**  
SC 500CP, SC 630CP, SC 800CP

Bottom left:  
**Europe's highest**  
**PV power station, Austria, 1 MWp**  
SMC 11000 TL

Bottom right:  
**Masdar City,**  
**United Arab Emirates, 10 MWp**  
SC 560 HE





Top left:  
**British Columbia  
Kanada , 26.40 kWp**  
SI 5048-US, MC-Box12-US,  
SB 6000-US

Top right:  
**York,  
Australia, 5 kWp**  
SI 5048, SB 3800

Bottom:  
**Tatakoto Island, Tahiti,  
French Polynesia, 120 kWp**  
SI 5048, MC-Box 36,  
SMC 10000TL

# Glossary

## Explanations regarding solar technology

### **Central inverter**

Central inverters are particularly well suited for use in PV plants with a homogenous structure (modules of the same kind with identical orientation and tilt). They are used for plants starting at 100 kW and, in most cases, are designed for outdoor installation.

### **Conversion efficiency**

The conversion efficiency is a property of the PV inverter and describes how much of the incoming DC power is output as AC power. Top-of-the-line devices from SMA achieve conversion efficiency levels of more than 99%. By way of comparison, modern passenger car diesel engines offer efficiency levels of no more than 45%.

### **Dump load**

Here: load which can be spontaneously activated in the event of an energy surplus; can also be used to balance out strong load fluctuations. Loads with storage capability (pumps, cooling units, boilers) are the most energy sensible. However, for the actual technical function, appropriately cooled resistors suffice.

### **ESS (Electronic Solar Switch)**

The ESS is a DC switch-disconnector integrated into the inverter to safely disconnect a PV array from the inverter. The ESS has a pull handle for ease of operation. After pulling down the handle, the DC plugs can be accessed and disconnected with no risk of an electrical arc. Disconnecting the plug means that the disconnection from the live PV array is immediately apparent.

### **H5 topology**

The bridge of inverters with H5 topology has a fifth semiconductor switch. This ensures very high efficiency in the conversion of current, at a factor of 98%.

### **HF**

HF stands for High Frequency and also designates the new Sunny Boy series with high frequency transformers. The compact, galvanically isolating inverters provide very high efficiency for devices with transformers.

### **Low-voltage ride through (LVRT)**

Grid management function from the field of dynamic grid support: When there is a short disruption in line voltage, the inverter does not switch off, as has been required until now, but supports the grid with reactive power. After the disturbance, it immediately resumes feeding. In Germany, for example, LVRT is required as of January 2011 for plants at the medium-voltage level.

### **Maximum Power Point (MPP)**

The operational point (current/voltage) of the PV array under which the highest possible power under the prevailing conditions is harvested. The actual MPP changes constantly depending, for example, on the level of irradiation and the temperature.

### **MPP trackers**

A device that adjusts the voltage and current of a PV array so that it operates at its "Maximum Power Point".

### **MSD**

Part of an "automatic disconnection device for generators". This is a mandatory safety device which prevents power from a solar energy system from being fed into an external power grid when the public supply grid is not functioning. This function is taken over by the Sunny Boy and Sunny Mini Central using SMA Grid Guard, thus making a regular test unnecessary due to their single fault characteristics.

### **Multistring inverter**

An inverter which, to a great extent, combines the advantages of several string inverters (separate MPP tracking of individual strings) and a central inverter (low specific costs).

### **Off-grid inverter**

Grid-forming inverters to establish an independent AC grid. It can continually maintain the voltage and frequency within the required limits in connection with a storage battery.

### **OptiCool**

A patented enclosure concept by SMA, in which the interior of the enclosure is divided into two compartments. The chamber with the sensitive electronics is dustproof and waterproof. The second chamber contains transformers and chokes as well as other unsusceptible components, and can be actively cooled when necessary.

### **Optiflex**

An innovative and highly-flexible design of the Sunny Tripower: The Sunny Tripower features an asymmetric multi-string input with two MPP trackers for custom-fit installation with nearly unlimited numbers of modules and maximum system efficiency.

### **Optiprotect (Medium Power Solutions)**

The Sunny Tripower features a completely new and comprehensive safety concept: Its electronic string fuses, automatic string failure detection and overvoltage protection that can be integrated into the enclosure all work to monitor the PV plant, ensure safe operation, and optimally secure your energy yield.

### **Optiprotect (Power Plant Solutions)**

The technology used to analyze errors directly in the inverter. An intelligent algorithm measures and analyzes the behavior of all strings and it can distinguish between actual errors and temporary errors. An intelligent algorithm measures and analyzes the behavior of all strings and it can distinguish between actual errors and temporary errors. Motor-driven circuit breakers can disconnect defective substrings, allowing the remaining portion of the PV plant to continue feeding in electricity.

### **OptiTrac Global Peak**

Another advance in our time-tested OptiTrac MPP tracker for operation in partially-shaded PV plants. This specialized operation management system ensures that the modules are constantly operated at the point of maximum power even when there are multiple maximum power points, without causing measurable yield loss (loss < 0.2 percent).

### **Power Balancer**

The Power Balancer is a Sunny Mini Central inverter standard function that prevents the formation of an unbalanced load during three-phase grid feed-in. This is accomplished by connecting three inverters to a three-phase feed-in unit via a control line.

### **Power frequency**

The power frequency is defined as the frequency of the alternating current in the public power distribution grid, i.e., the speed at which the polarity of the voltage oscillates. If more energy is drawn from the grid than is fed in, the power frequency decreases; if there is surplus generative capacity, it increases. To ensure that the power distribution grid operates safely, the frequency must be maintained within narrow limits. In Europe, the target value is 50 Hz (= 100 polarity reversals per second).

### **Quick Module**

A removable communication and configuration module for the new Sunny Boy HF series. There is a rotary switch inside to set the country and the *Bluetooth* NetID as well as the SD card slot. The optionally available Quick Module RS485 also features an RS485 interface and a multi-function relay.

### **SMA Grid Guard**

The SMA Grid Guard concept monitors, for instance, the voltage and frequency of the connected power distribution grid according to predefined parameters. This serves to prevent the formation of islanding in the event of grid disconnection (see also "MSD"). Grid Guard enables simple and reliable operation of SMA inverters on nearly all electrical power grids worldwide.

### **SMA Plug-in Grounding**

A grounding set for the new Sunny Boy HF series. Grounding is quick and simple – an easy plug-in without opening the enclosure. The polarity is defined by the orientation in which the grounding is attached.

### **SMA Utility Grade**

An integrated concept that bundles SMA system technology and services for implementing PV power plants worldwide. All products bearing this label meet all the requirements placed on state-of-the-art, competitive PV power stations.

### **String inverter**

In string technology, the PV array is divided into separate module surfaces and each of these "strings" is assigned to a separate string inverter. This technology reduces system costs while at the same time substantially simplifying installation and increasing the energy yield and plant availability.

### **SUNCLIX**

A DC connection system for all SMA inverters, developed in cooperation with Phoenix Contact. The field plugs can be connected to almost any cable without special tools, and are included with inverters free of charge.

### **VDE application guide 4105**

VDE-AR-N 4105 is a technical regulation for electricity generators that feed their energy into the low-voltage grid and is therefore applicable to all small- and medium-scale PV systems in Germany. It has been binding for all new systems installed since January 1, 2012 and describes the characteristics and settings that an inverter needs for helping to ensure the stability of the power distribution grid.

# » SMA innovations



**2012**

## Sunny Tripower TL

The High Efficiency series: highly profitable and highly efficient

The Sunny Tripower 20000 TL High Efficiency is the ideal decentralized inverter solution for highly efficient medium-size to large-scale PV plants with its maximum efficiency of 99.15 percent.

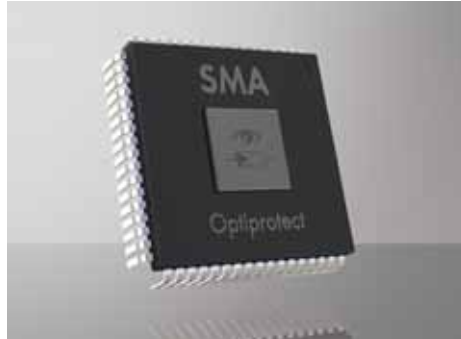

**2011**

## Optiprotect

Intelligent string monitoring for central inverters

An algorithm installed directly in the inverter monitors and analyzes errors. Optiprotect reliably distinguishes between actual errors and temporary errors



**2010**

## Sunny Central 800CP

High performance as standard

Compact, weather-proof enclosure and intelligent power management: the new Sunny Central series does not need a heavy concrete substation and thus decreases system costs



**2009**

## Sunny Island 2012

Compact and powerful with peak efficiency

Bidirectional HF inverter, galvanic isolation, reduced weight, excellent efficiency



**2008**

## Sunny Boy 5000TL

Perfection Plus. Easy to use. The new Sunny Boy generation.

Bluetooth technology, graphic display, suitable for use worldwide and easy to install: cutting-edge technology meets user convenience



**2007**

## Sunny Backup system

Solar power – even in the event of grid failure

Awarded the 2007 innovation prize for the most innovative solar product



2010

### Sunny Boy 3000HF

A high yield performer

The new generation of galvanically-isolating inverters: Highest yields in its performance class and easiest installation thanks to the SMA Plug-in Grounding, SUNCLIX and Quick Module



2010

### Sunny Tripower 17000TL

The three-phase inverter for easy plant design

Packed full of pioneering technology: with Optiprotect multi-level security concept and Optiflex for flexible plant configuration



2009

### Sunny Central 630HE

Includes grid management

Optimum future prospects: More power with lower specific system costs, high flexibility for plant design, and compliance with the medium-voltage directive of the BDEW



2006

### ESS

Electronic Solar Switch

Our first device-integrated DC switch-disconnector for safely disconnecting the PV array from the inverter



2006

### Sunny Mini Central 8000TL

The world amortization champion

H5 topology, record efficiency of 98 %, low specific price: No other pays off faster



2005

### Sunny Portal

Internet portal for the presentation of plant data

Customized plant monitoring and individual visualization at [www.SunnyPortal.com](http://www.SunnyPortal.com)



# » SMA innovations



2004

## Sunny WebBox

Data logger of the new generation

Innovative monitoring and communication with the PV plant via Internet (Sunny Portal)



2003

## Sunny Beam

The easiest to use radio-controlled PV plant monitoring system

Attractive design for the living area, power supply via integrated PV cell



2002

## Sunny Central

Central inverters for PV power stations

With string monitoring, Sunny Central Team, and optimal service, Sunny Central is the large-scale solution

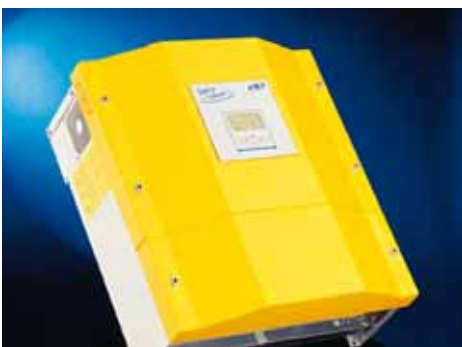

2001

## Sunny Island

The system solution for off-grid power supply

User-friendly connection for all components on the AC side, easy installation and extension of the plant



1995

## Sunny Boy 700

First string inverter

Cost reductions thanks to minimized DC wiring, easier installation and increased efficiency



1991

## PV-WR

First PV inverter designed for serial production

User display, communication and visualization with PC

# Publication information

Published by:  
**SMA Solar Technology AG**

Photos

**Stefanie Aumiller**

**Andreas Berthel**

**Stephan Daub**

**Lucidmedia**

**Constantin Meyer**

**Joan Carles Milà**

**shutterstock**

SMA, SMA Solar Technology, SMA Solar Academy, Sunny Boy, Sunny Central, Sunny Island, Sunny Beam, Sunny Design, Sunny Explorer, Sunny Family, Sunny, Hydro Boy, smartload, Sunny Backup, Sunny Easy, Sunny PRO Club, Sunny Team, Sunny Tripower, OptiTrac, Windy Boy, Sunny Matrix, Sunny Portal, Sunny Tower, Sunny WebBox, Multi-String, OptiCool, Grid Guard, Optiprotect, Optiflex, Power Balancer, SMA Off-Grid Configurator, Sunny Home Manager and H5 are registered trademarks of SMA Solar Technology AG.

The *Bluetooth*<sup>®</sup> word mark and logos are registered trademarks owned by Bluetooth SIG, Inc. and any use of these marks by SMA Solar Technology AG is under licence.

SUNCLIX is a registered trademark of PHOENIX CONTACT GmbH & Co. KG.

Text and illustrations reflect the current state of the technology at the time of publication. Subject to technical changes. No liability for printing errors.

Printed on chlorine-free paper.

All trademarks are acknowledged, even if not explicitly identified as such. A lack of identification does not mean that a product or symbol is not trademarked.

This text and excerpts thereof may only be reprinted with written approval from the publisher.



**SMA Solar Technology**

**www.SMA-Solar.com**

**SMA Solar Technology AG**

[www.SMA.de](http://www.SMA.de)

**SMA America, LLC**

[www.SMA-America.com](http://www.SMA-America.com)

**SMA Australia Pty. Ltd.**

[www.SMA-Australia.com.au](http://www.SMA-Australia.com.au)

**SMA Benelux SPRL**

[www.SMA-Benelux.com](http://www.SMA-Benelux.com)

**SMA Beijing Commercial Co., Ltd.**

[www.SMA-China.com](http://www.SMA-China.com)

**SMA Canada, Inc.**

[www.SMA-Canada.ca](http://www.SMA-Canada.ca)

**SMA Central & Eastern Europe s.r.o.**

[www.SMA-Czech.com](http://www.SMA-Czech.com)

**SMA France S.A.S.**

[www.SMA-France.com](http://www.SMA-France.com)

**SMA Hellas AE**

[www.SMA-Hellas.com](http://www.SMA-Hellas.com)

**SMA Ibérica Tecnología Solar, S.L.**

[www.SMA-Iberica.com](http://www.SMA-Iberica.com)

**SMA Solar India Pvt. Ltd.**

[www.SMA-India.com](http://www.SMA-India.com)

**SMA Italia S.r.l.**

[www.SMA-Italia.com](http://www.SMA-Italia.com)

**SMA Japan K.K.**

[www.SMA-Japan.com](http://www.SMA-Japan.com)

**SMA Technology Korea Co., Ltd.**

[www.SMA-Korea.com](http://www.SMA-Korea.com)

**SMA Solar Thailand Co., Ltd.**

[www.SMA-Thailand.com](http://www.SMA-Thailand.com)

**SMA Solar UK Ltd.**

[www.SMA-UK.com](http://www.SMA-UK.com)

ENERGY  
THAT  
CHANGES

